



NEW WARE NEWSLETTER

NEW MASKS MARCH 2025

NWAM1284 1/48 Mi-24A Hind B BASIC kabuki masks	Trumpeter
NWAM1285 1/48 Mi-24A Hind B EXPERT kabuki masks	Trumpeter
NWAM1286 1/48 TA-4H/ J Skyhawk IAF BASIC kabuki masks	Hobby 2000
NWAM1287 1/48 TA-4H/ J Skyhawk IAF EXPERT kabuki masks	Hobby 2000
NWAM1288 1/48 Westland Lysander Mk.I & Mk.III BASIC kabuki masks	Airfix
NWAM1289 1/48 Westland Lysander Mk.I & Mk.III EXPERT kabuki masks	Airfix

NWAM1285

1/48 scale



Mi-24A Hind-B EXPERT kabuki masks

for Trumpeter 05828 kit

<http://mek.kosmo.cz/newware>

INCLUDES ALSO WINDOWS
INNER SIDE AND CAMOUFLAGE
DETAILS MASKS

tom.nwkits@seznam.cz

Important:

Let the sprayed color dry before applying masks. Remove masks very carefully after painting.
Where the mask is divided into A and B parts, first apply part A, next part B.
The set does not include masks for all areas, so mask the rest with masking tape or liquid mask.

K kit part

* start placing the mask from this point

Placing wet masks on wet surface is recommended, except those marked by **W**

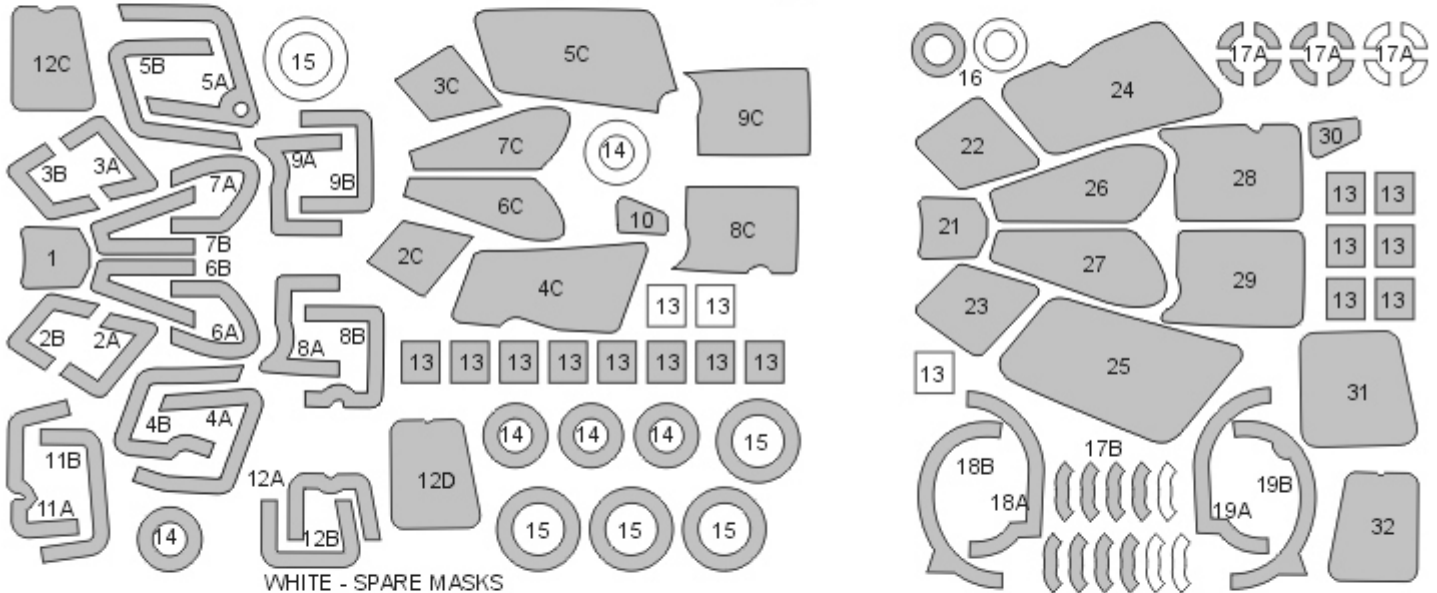

WHITE - SPARE MASKS

STEP 1 - exterior view
mask interior, paint interior color

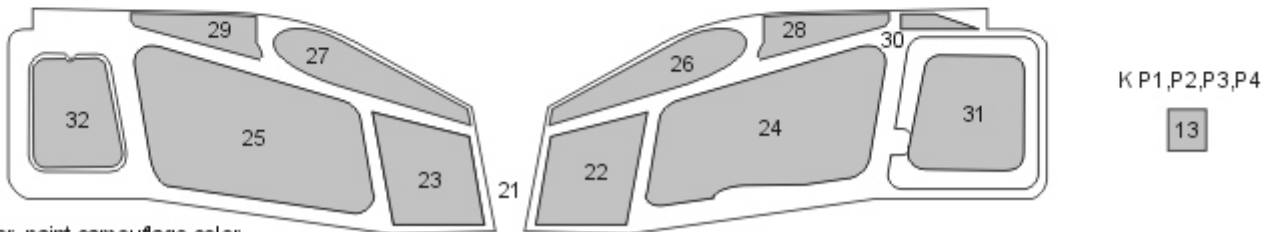

STEP 2
mask exterior, paint camouflage color

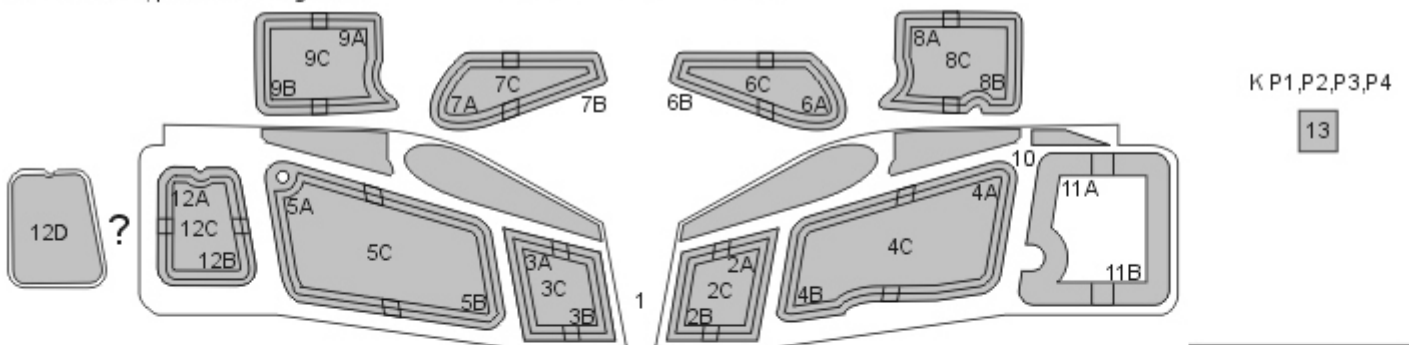

K A30

K D9

K A38+A32

K A19+A25

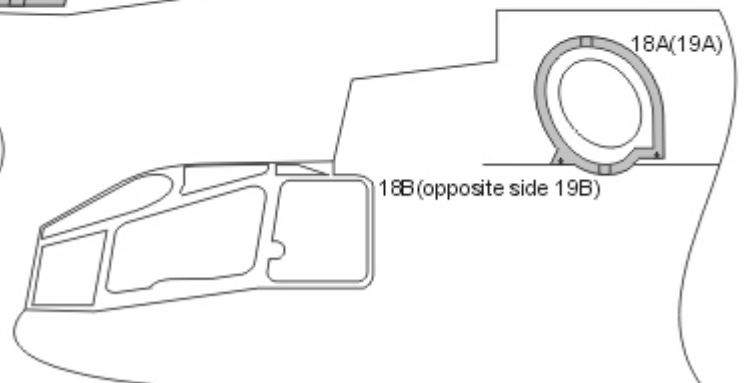
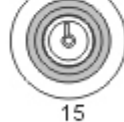



TA-4H/J Skyhawk IAF BASIC kabuki masks

for Hobby 2000 48035 kit

<http://mek.kosmo.cz/newware>

tom.nwkits@seznam.cz

Important:

Let the sprayed color dry before applying masks. Remove masks very carefully after painting.
 Where the mask is divided into A and B parts, first apply part A, next part B.
 The set does not include masks for all areas, so mask the rest with masking tape or liquid mask.

K kit part

^ start placing the mask from this point

Placing wet masks on wet surface is recommended, except those marked by **W**

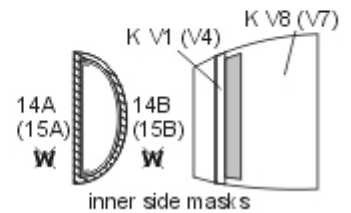
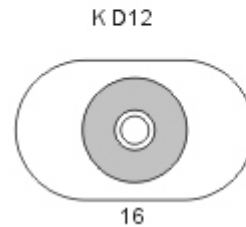
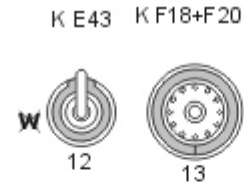
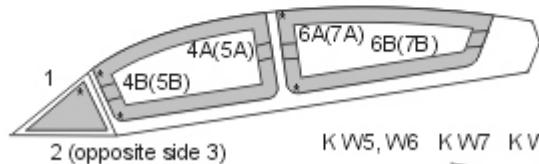
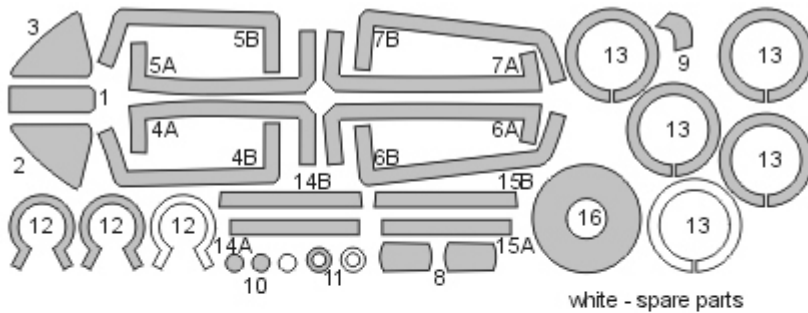



NW AM1287

TA-4H/J Skyhawk IAF EXPERT kabuki masks

for Hobby 2000 48035 kit

<http://mek.kosmo.cz/newware>

INCLUDES ALSO WINDOWS
INNER SIDE AND CAMOUFLAGE
DETAIL MASKS

1/48 scale

tom.nwkits@seznam.cz

Important:

Let the sprayed color dry before applying masks. Remove masks very carefully after painting.

Where the mask is divided into A and B parts, first apply part A, next part B.

The set does not include masks for all areas, so mask the rest with masking tape or liquid mask.

K kit part

^ start placing the mask from this point

Placing wet masks on wet surface is recommended, except those marked by **W**

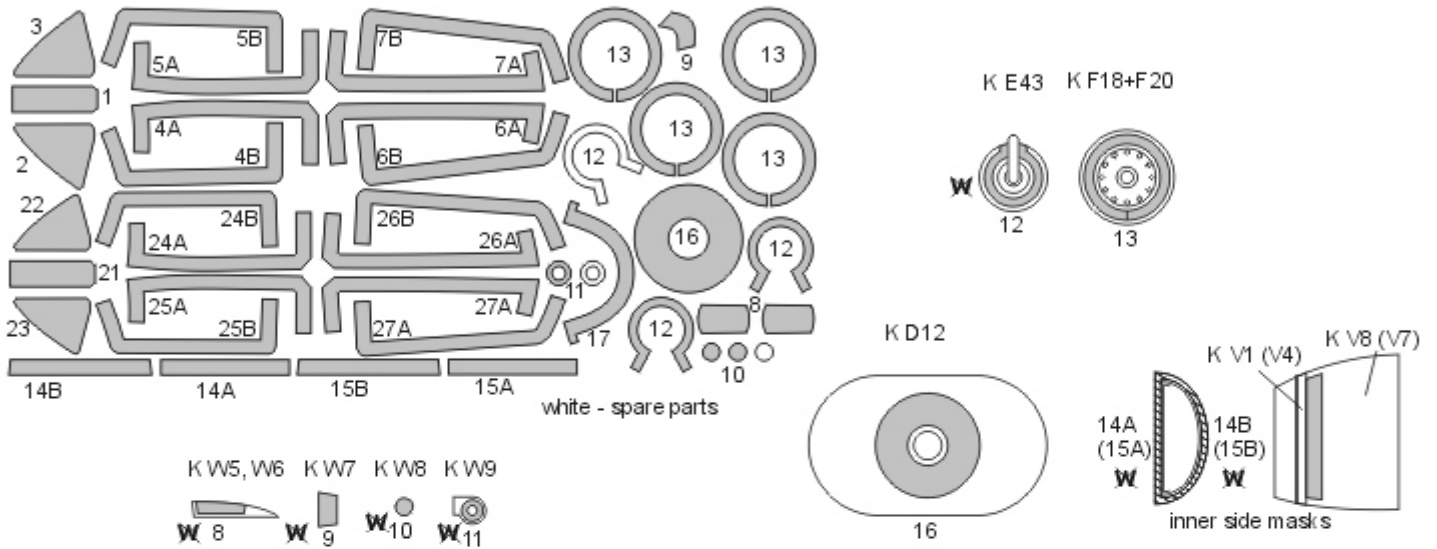

STEP 1 - exterior view

mask interior
paint interior color

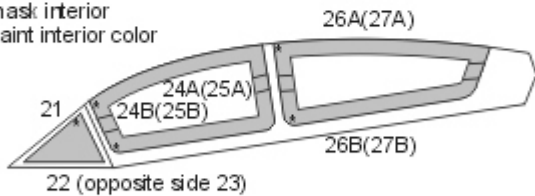

STEP 2

mask exterior
paint camouflage color

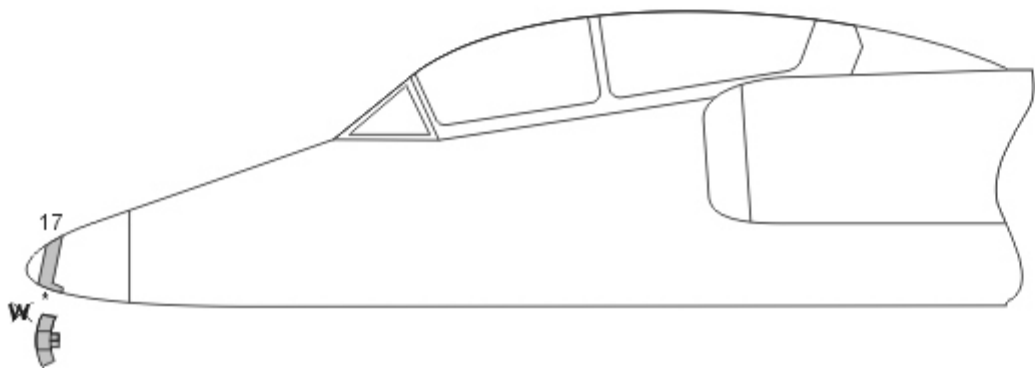
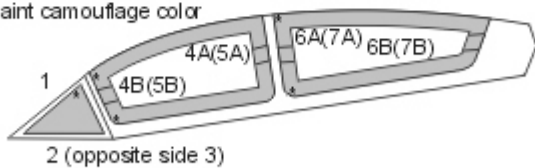



Westland Lysander Mk.I & Mk.III BASIC kabuki masks

for Airfix A07116 kit

<http://mek.kosmo.cz/newware>

tom.nwkits@seznam.cz

Important:

Let the sprayed color dry before applying masks. Remove masks very carefully after painting.
Where the mask is divided into A and B parts, first apply part A, next part B.
The set does not include masks for all areas, so mask the rest with masking tape or liquid mask.

K kit part

* start placing the mask from this point

Placing wet masks on wet surface is recommended, except those marked by **W**

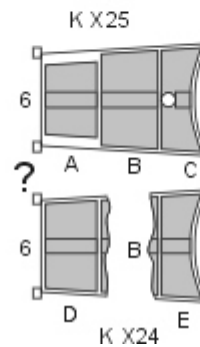
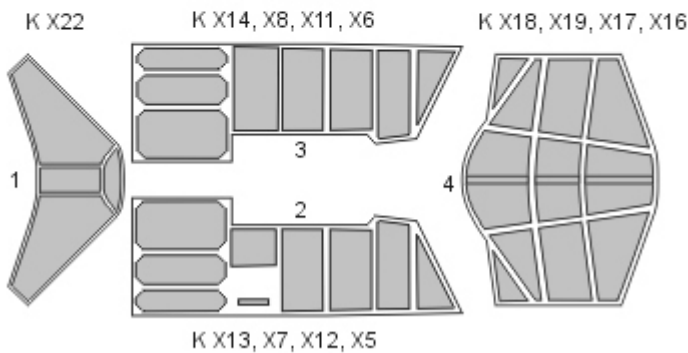
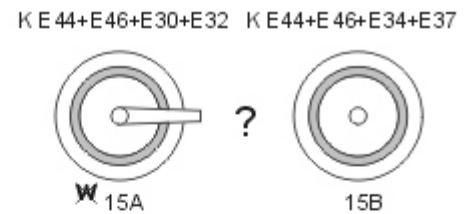
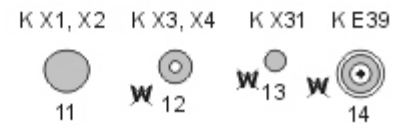
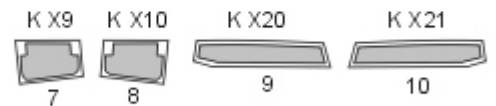
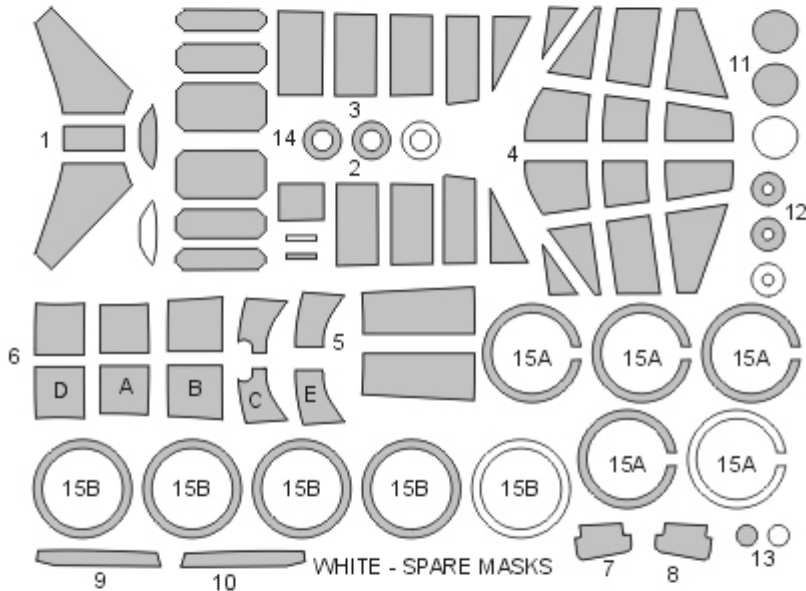



INCLUDES ALSO WINDOWS
INNER SIDE MASKS

Important:

Let the sprayed color dry before applying masks. Remove masks very carefully after painting.
Where the mask is divided into A and B parts, first apply part A, next part B.
The set does not include masks for all areas, so mask the rest with masking tape or liquid mask.

K kit part

* start placing the mask from this point

Placing wet masks on wet surface is recommended, except those marked by **W**

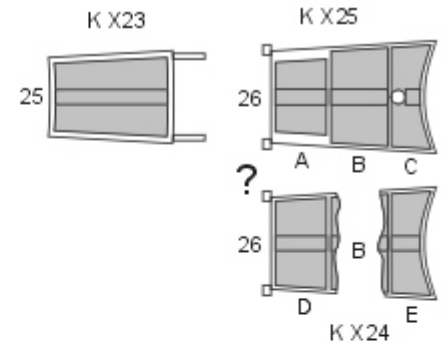
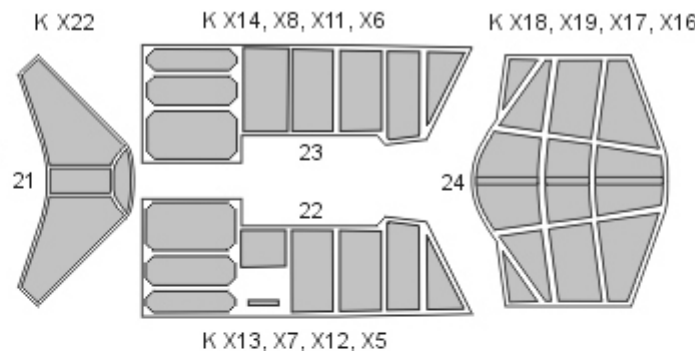
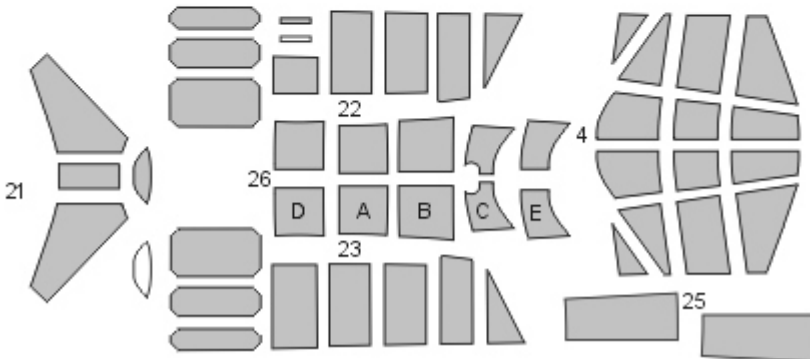
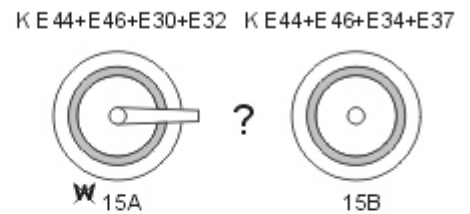
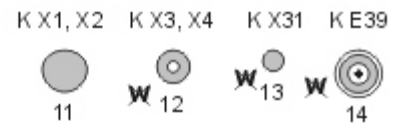
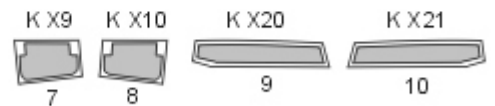
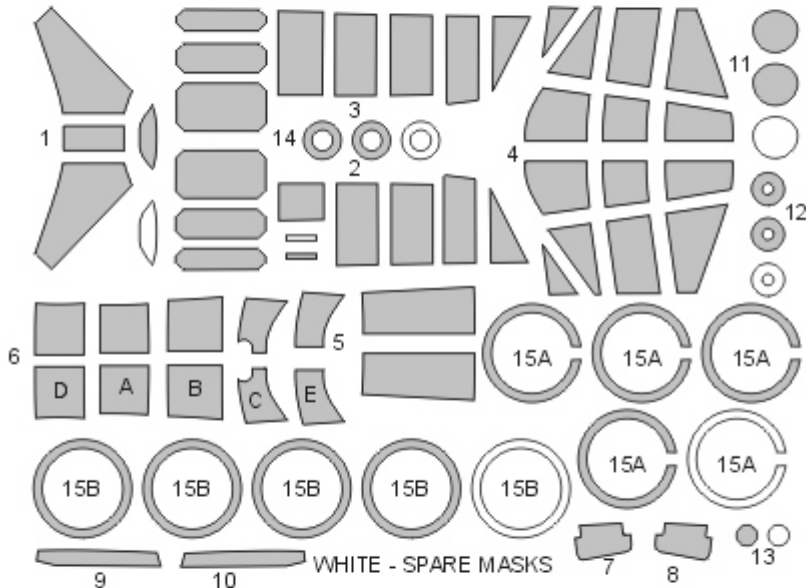

STEP 1 - exterior view
mask interior

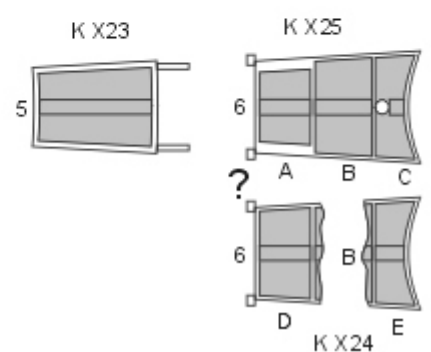
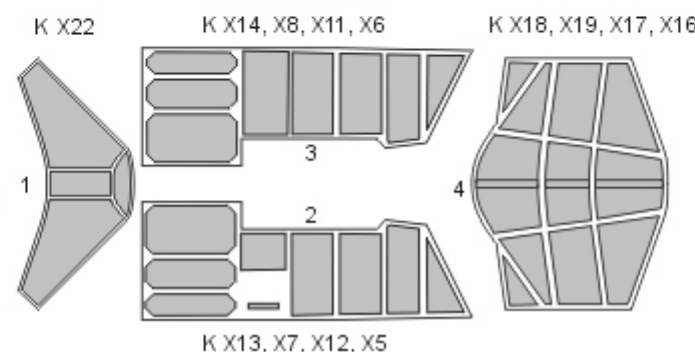

STEP 2
mask exterior