



# NEW WARE NEWSLETTER

## NEW MASKS FEBRUARY 2025

NWAM 1264 1/48 Sikorski H-19A Chickasaw BASIC kabuki masks	AMP
NWAM 1265 1/48 Sikorski H-19A Chickasaw ADVANCED kabuki masks	AMP
NWAM 1266 1/48 Sikorski H-19A Chickasaw EXPERT kabuki masks	AMP
NWAM 1267 1/48 LaGG-3 (Series 66) kabuki masks	Zvezda
NWAM 1268 1/48 Polikarpov I-16 Type 5 kabuki masks	Zvezda
NWAM 1269 1/48 B-24D Liberator BASIC kabuki masks	HobbyBoss
NWAM 1270 1/48 B-24D Liberator EXPERT kabuki masks	HobbyBoss
NWAM 1271 1/48 F-14D Tomcat BASIC kabuki masks	G.W.H
NWAM 1272 1/48 F-14D Tomcat EXPERT kabuki masks	G.W.H
NWAM 1273 1/48 MH-60L Black Hawk BASIC kabuki masks	ICM
NWAM 1274 1/48 MH-60L Black Hawk EXPERT kabuki masks	ICM
NWAM 1275 1/72 F-14D BASIC kabuki masks	Academy
NWAM 1276 1/72 F-14D EXPERT kabuki masks	Academy
NWAM 1277 1/48 F-35C Lightning II BASIC kabuki masks	Tamiya
NWAM 1278 1/48 F-35C Lightning II EXPERT kabuki masks	Tamiya
NWAM 1279 1/48 F-35C Lightning II CAMOUFLAGE kabuki masks	Tamiya
NWAM 1280 1/48 UH-60A Black Hawk BASIC kabuki masks	ICM
NWAM 1281 1/48 UH-60A Black Hawk EXPERT kabuki masks	ICM
NWAM 1282 1/48 Westland Sea King HC.4 ADVANCED kabuki masks	Airfix
NWAM 1283 1/48 Westland Sea King HC.4 EXPERT kabuki masks	Airfix



## Sikorski H-19A Chickasaw BASIC kabuki masks

for AMP 48022 kit

<http://mek.kosmo.cz/newware>

tom.nwkits@seznam.cz

**Important:**

Let the sprayed color dry before applying masks. Remove masks very carefully after painting.  
Where the mask is divided into A and B parts, first apply part A, next part B.  
The set does not include masks for all areas, so mask the rest with masking tape or liquid mask.

K kit part

\* start placing the mask from this point

Placing wet masks on wet surface is recommended, except those marked by **W**

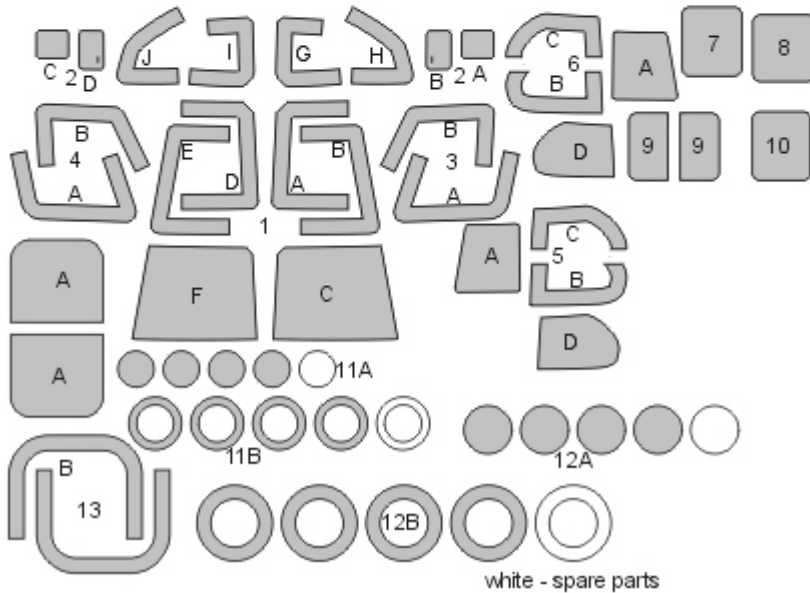

white - spare parts

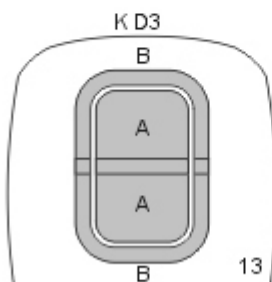
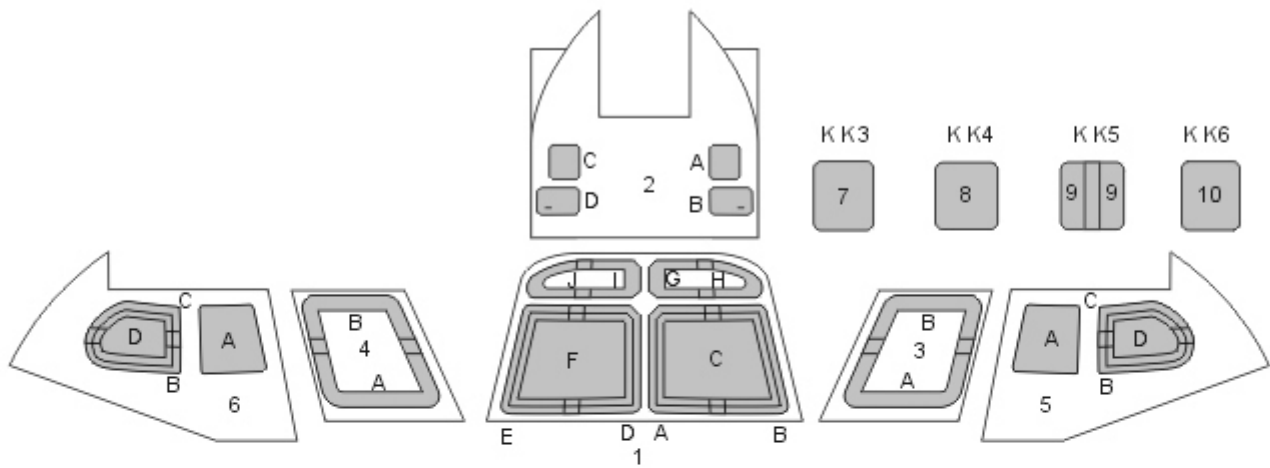

paint door color  
apply masks 13A  
paint interior color  
add masks 13B  
paint frame color

K K3    K K4    K K5    K K6



# NWAM1265



Sikorski H-19A Chickasaw **ADVANCED** kabuki masks

for AMP 48022 kit

<http://mek.kosmo.cz/newware>

INCLUDES ALSO  
WINDOWS SEAL AND GRILLES MASKS

1/48 scale

tom.nwkits@seznam.cz

### Important:

Let the sprayed color dry before applying masks. Remove masks very carefully after painting.

Where the mask is divided into A and B parts, first apply part A, next part B.

The set does not include masks for all areas, so mask the rest with masking tape or liquid mask.

K kit part

^ start placing the mask from this point

Placing wet masks on wet surface is recommended, except those marked by **W**

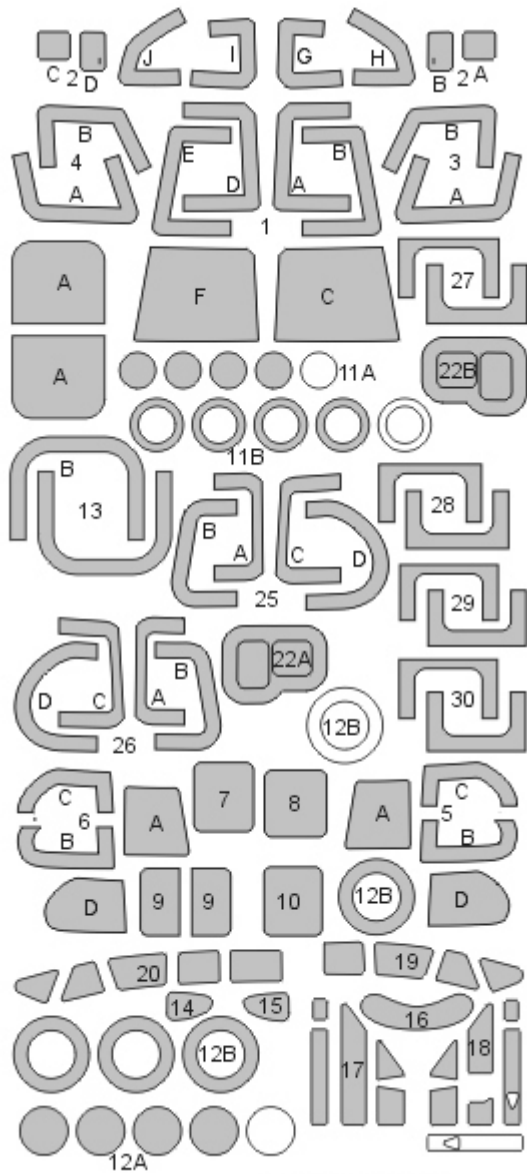

white - spare parts

STEP 1  
mask exterior, paint camouflage color

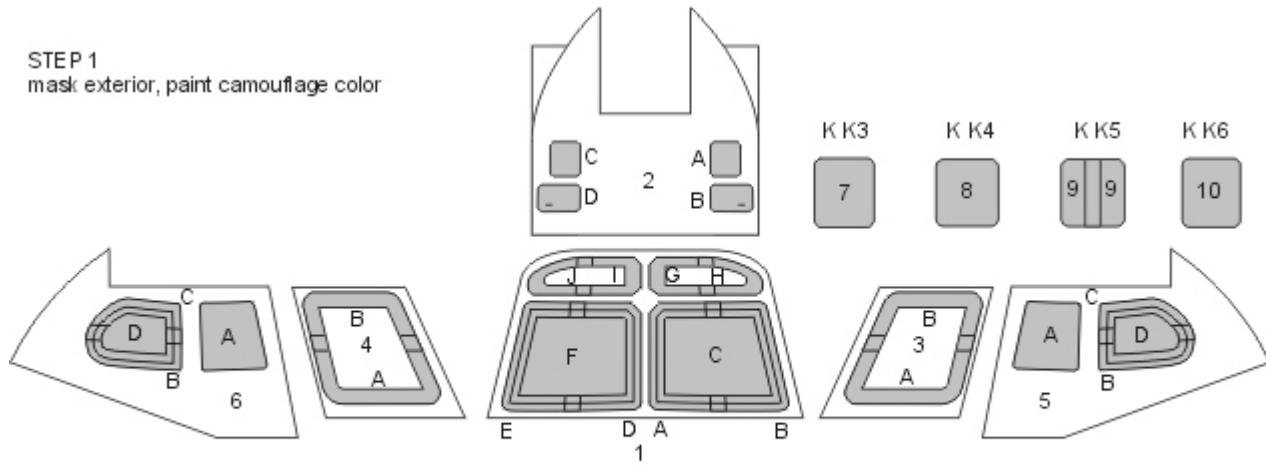

STEP 2  
mask exterior, paint seal color (rubber black)

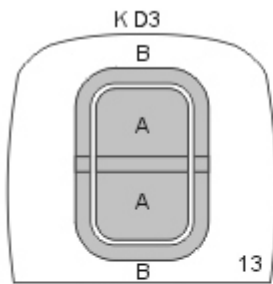
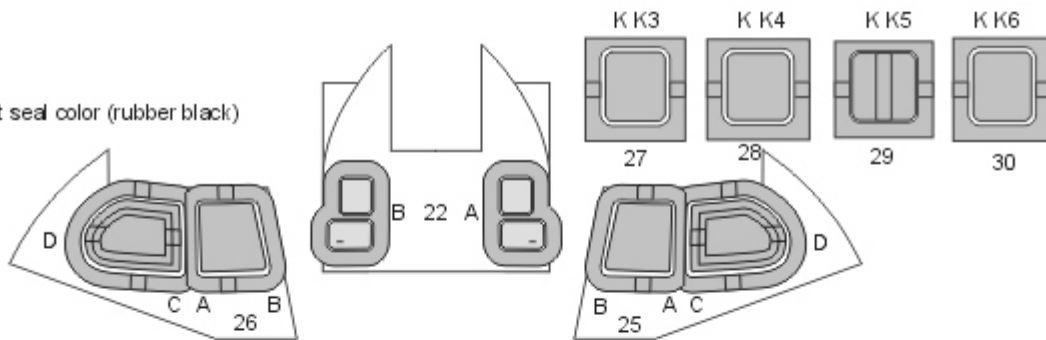

paint door color  
apply masks 13A  
paint interior color  
add mask's 13B  
paint frame color

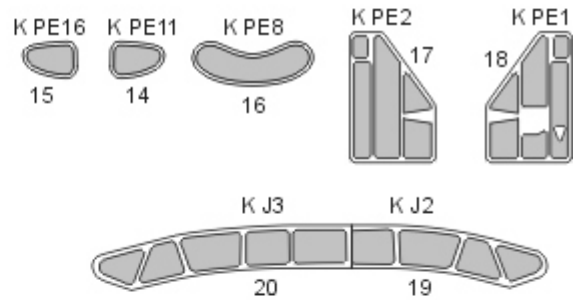

K J19(21) + J18(20) K J31-34 + J22,23 + J15,17





NWAM1266

Sikorski H-19A Chickasaw EXPERT kabuki masks

for AMP 48022 kit

<http://mek.kosmo.cz/newware>

INCLUDES ALSO  
WINDOWS SEAL AND INNER SIDE  
AND GRILLES MASKS

1/48 scale

tom.nwkits@seznam.cz

**Important:**

Let the sprayed color dry before applying masks. Remove masks very carefully after painting.

Where the mask is divided into A and B parts, first apply part A, next part B.

The set does not include masks for all areas, so mask the rest with masking tape or liquid mask.

K kit part

\* start placing the mask from this point

Placing wet masks on wet surface is recommended, except those marked by **W**

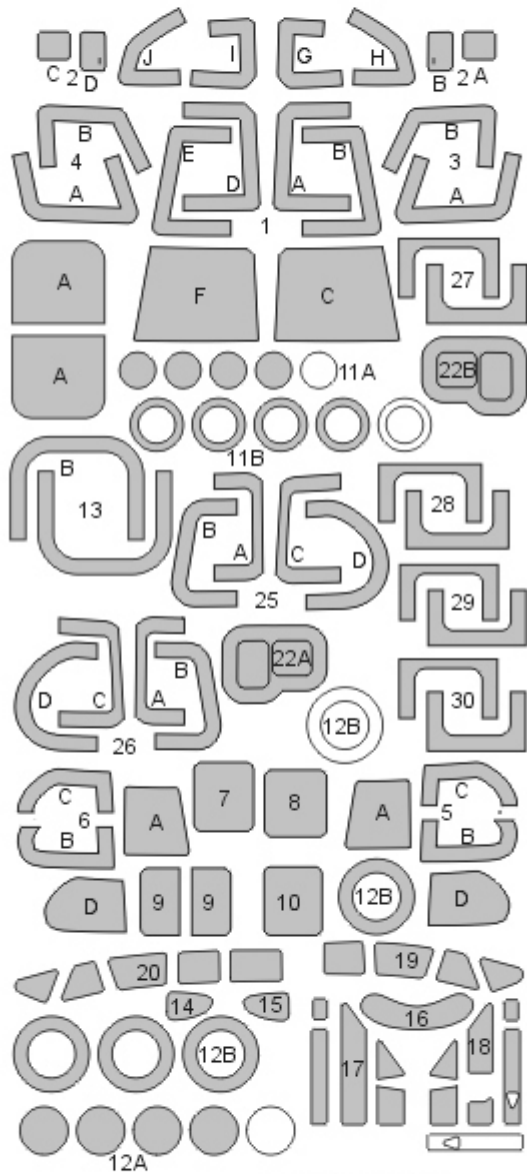

white - spare parts

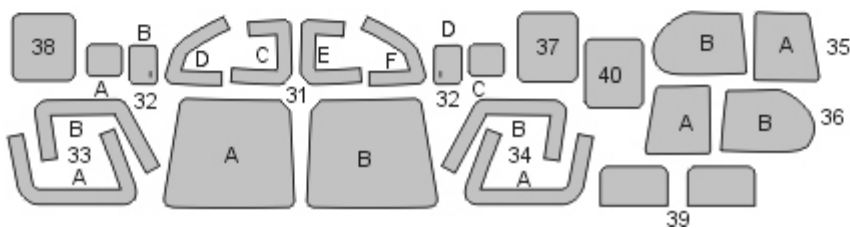

STEP 1 (exterior view)  
mask interior, paint interior color

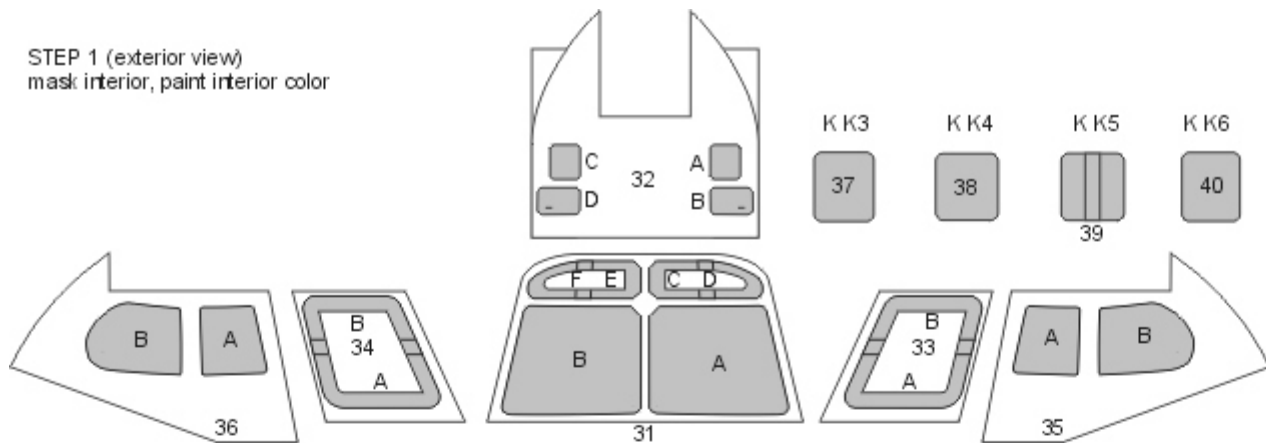

STEP 2  
mask exterior, paint camouflage color

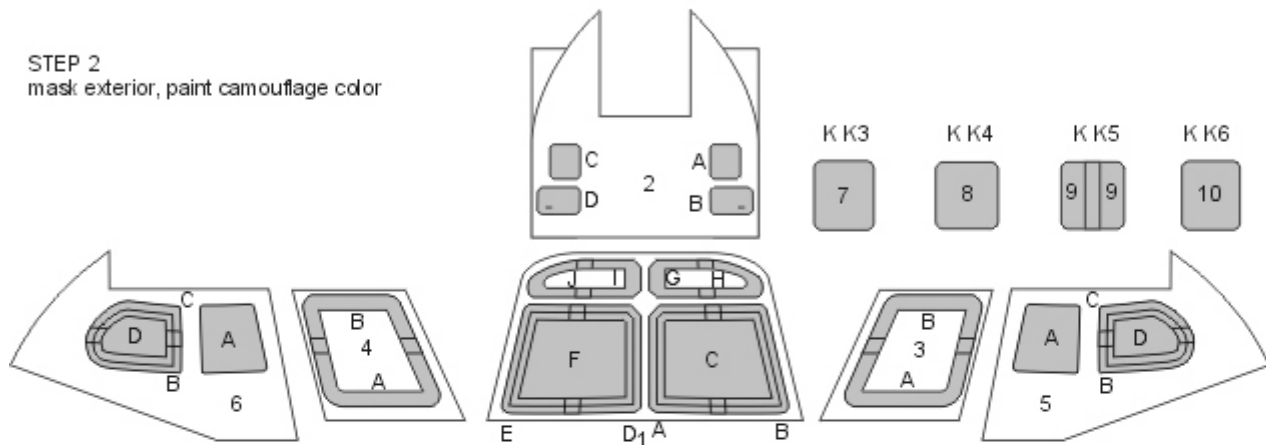

STEP 3  
mask exterior, paint seal color (rubber black)

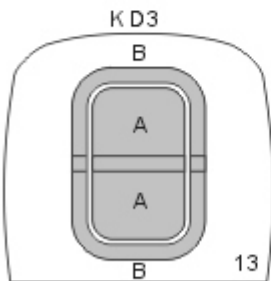
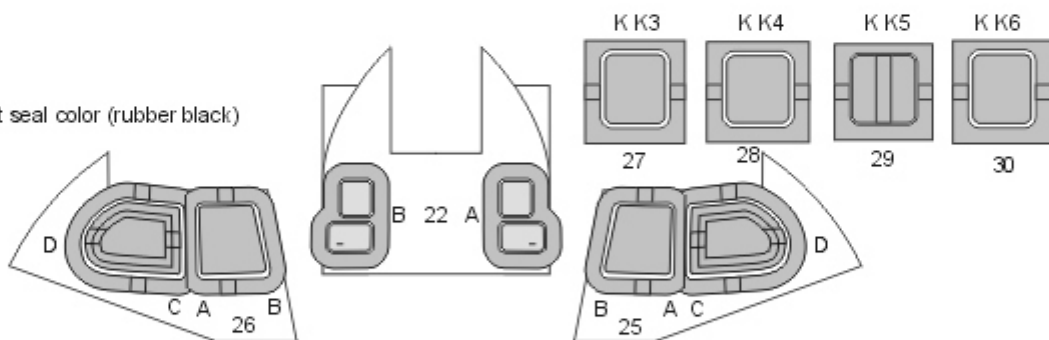

paint door color  
apply mask s 13A  
paint interior color  
add mask s 13B  
paint frame color

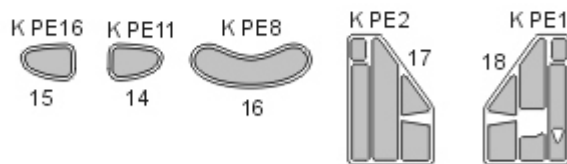

K J19(21) + J18(20) K J31-34 + J22,23 + J15,17



# NWAM1267

1/48 scale



LaGG-3 (series 66) kabuki masks

for Zvezda 4833 kit

<http://mek.kosmo.cz/newware>

tom.nwkits@seznam.cz

### Important:

Let the sprayed color dry before applying masks. Remove masks very carefully after painting.

Where the mask is divided into A and B parts, first apply part A, next part B.

The set does not include masks for all areas, so mask the rest with masking tape or liquid mask.

K kit part

^ start placing the mask from this point

Placing wet masks on wet surface is recommended, except those marked by **W**

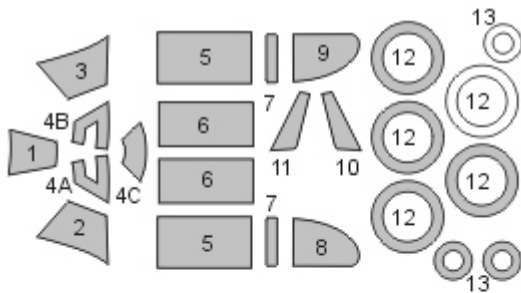

K A11+A13+A1+A3    K D8



white - spare parts

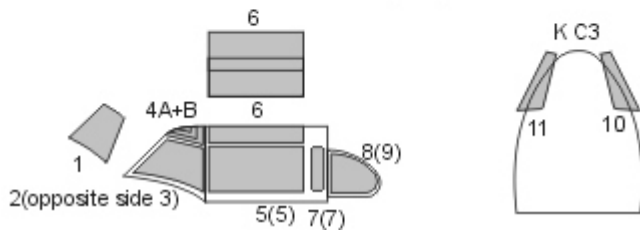

# NWAM1268

1/48 scale



Podikarpov I-16 Type 5 kabuki masks

for Zvezda 4832 kit

<http://mek.kosmo.cz/newware>

tom.nwkits@seznam.cz

### Important:

Let the sprayed color dry before applying masks. Remove masks very carefully after painting.

Where the mask is divided into A and B parts, first apply part A, next part B.

The set does not include masks for all areas, so mask the rest with masking tape or liquid mask.

K kit part

\* start placing the mask from this point

Placing wet masks on wet surface is recommended, except those marked by **W**

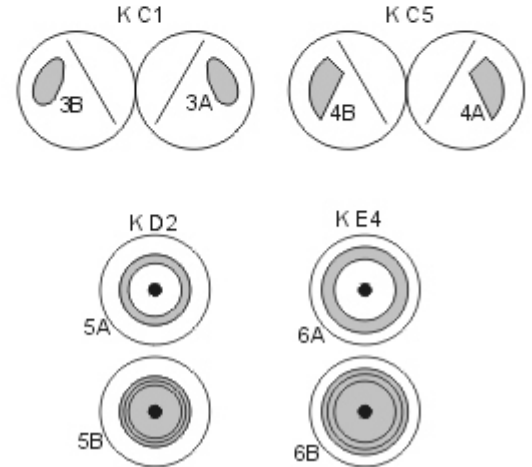
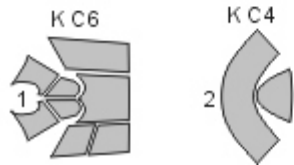
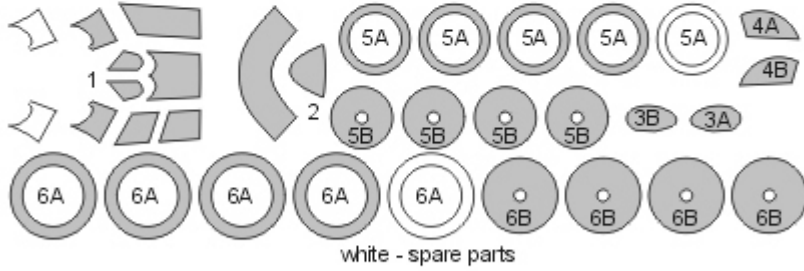





## B-240 Liberator BASIC kabuki masks

for HobbyBoss 81775 kit

<http://mek.kosmo.cz/newware>

tom.nwkits@seznam.cz

### Important:

Let the sprayed color dry before applying masks. Remove masks very carefully after painting.

Where the mask is divided into A and B parts, first apply part A, next part B.

The set does not include masks for all areas, so mask the rest with masking tape or liquid mask.

K kit part

\* start placing the mask from this point

Placing wet masks on wet surface is recommended, except those marked by **W**

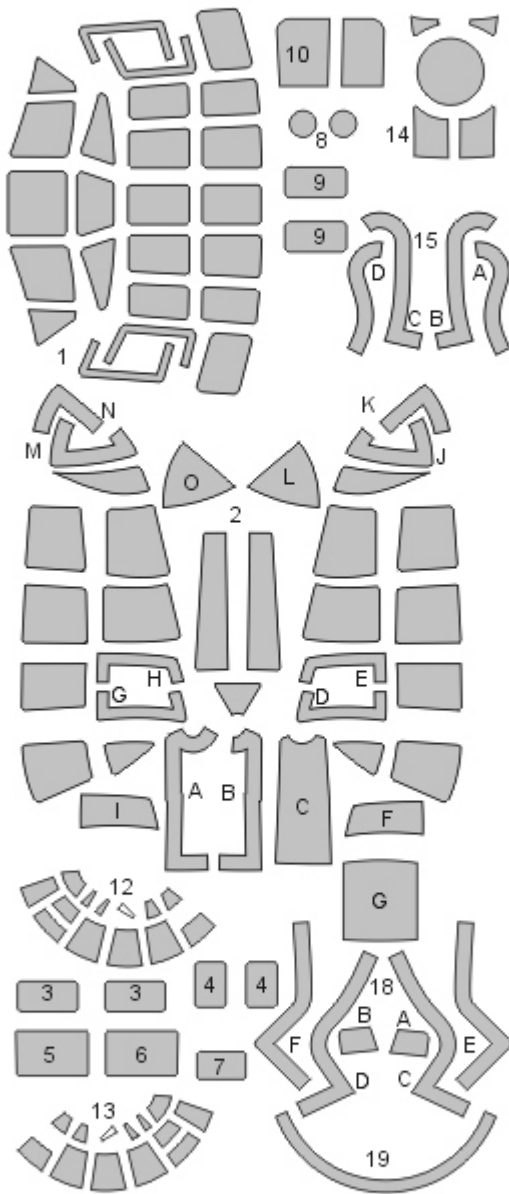

WHITE - SPARE MASKS

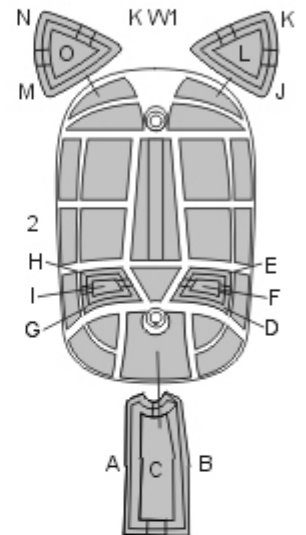
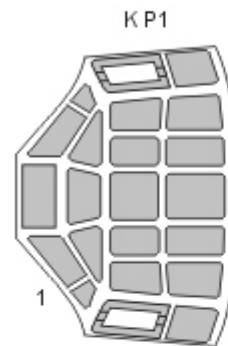

KP6,P7 KP8,P9 KP12 KP13 KP17 KP18,P19



KW2,W3 KW4 KP10 KW5

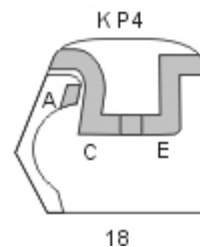
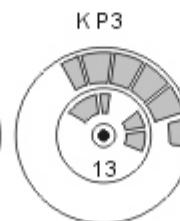
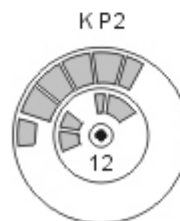
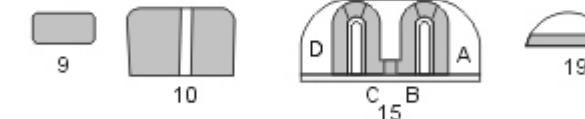

18

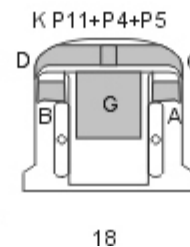

18

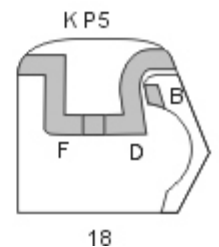

18



# NWAM1270

## B-24D Liberator EXPERT kabuki masks

### for HobbyBoss 81775 kit

<http://mek.kosmo.cz/newware>

Includes also windows  
inner side, yellow stripes on bombs  
and camouflage details masks

1/48 scale

tom.nwkits@seznam.cz

#### Important:

Let the sprayed color dry before applying masks. Remove masks very carefully after painting.

Where the mask is divided into A and B parts, first apply part A, next part B.

The set does not include masks for all areas, so mask the rest with masking tape or liquid mask.

K kit part

^ start placing the mask from this point

Placing wet masks on wet surface is recommended, except those marked by **W**

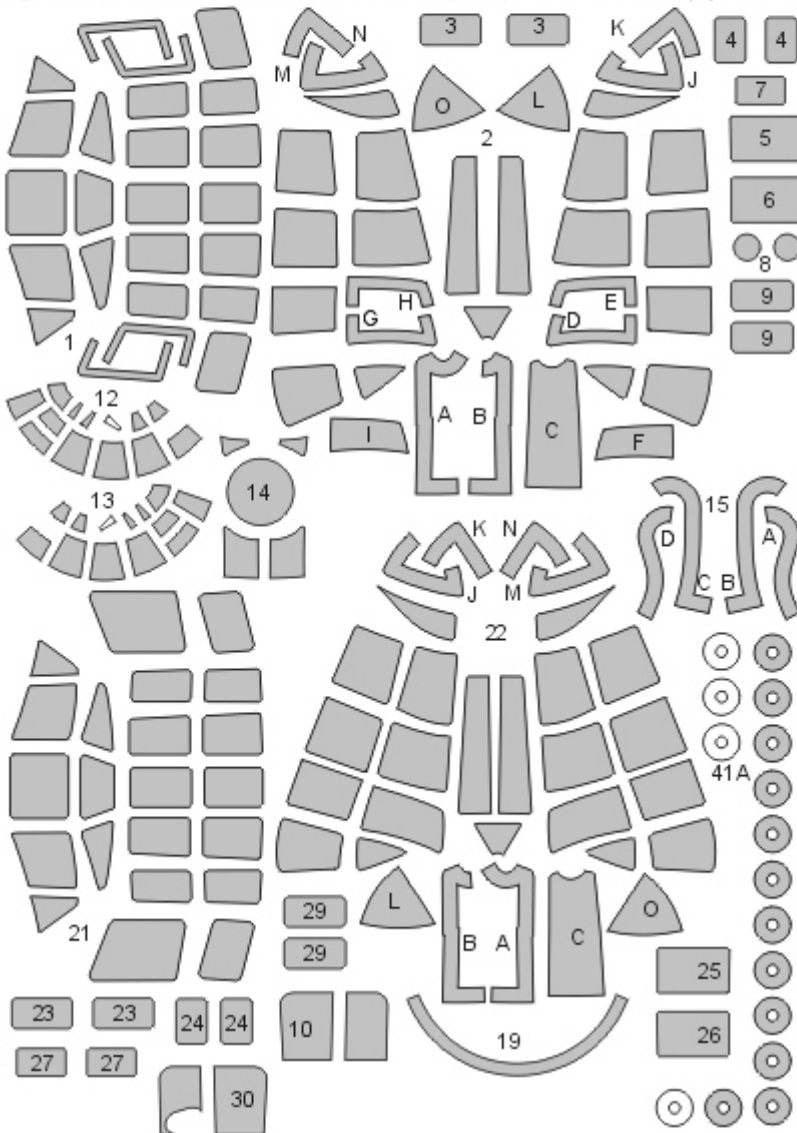

#### WHITE - SPARE MASKS

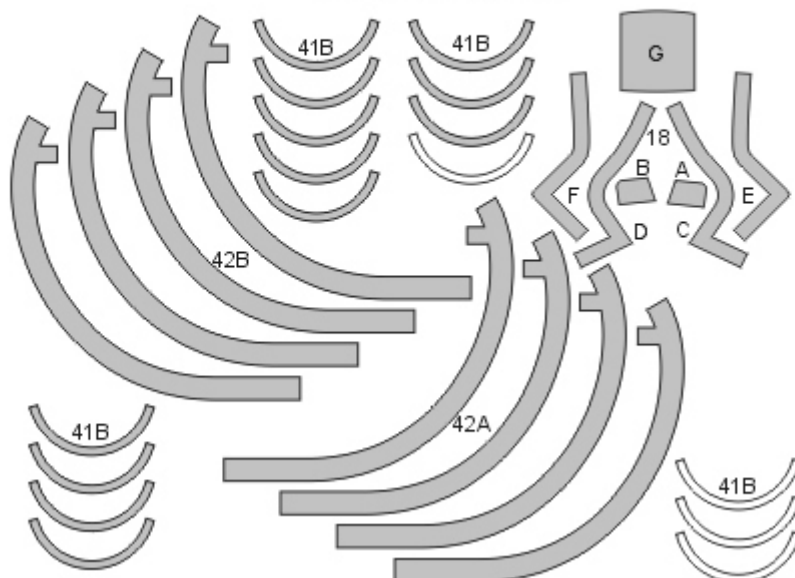

**STEP 1 - exterior view**  
mask interior, paint interior color

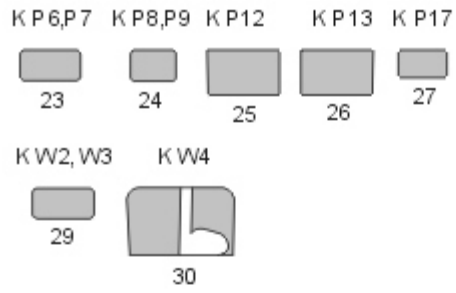
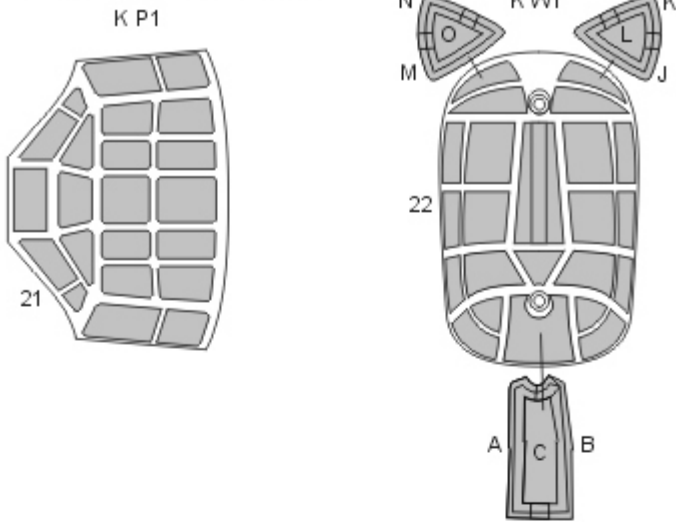

**STEP 2**  
mask exterior, paint camouflage color

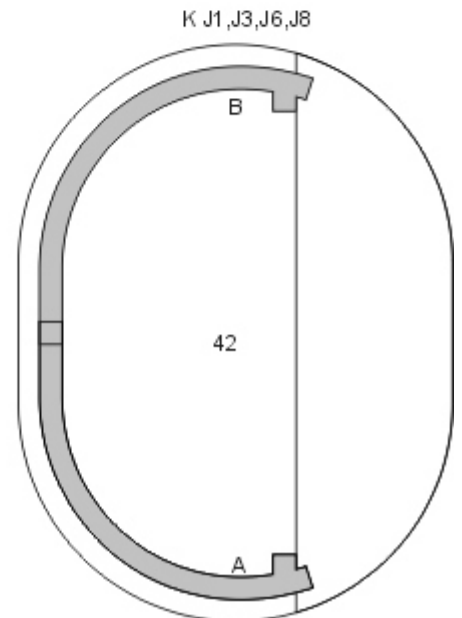
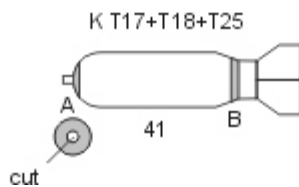
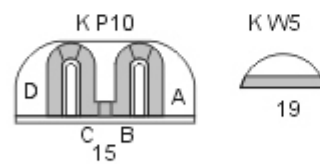
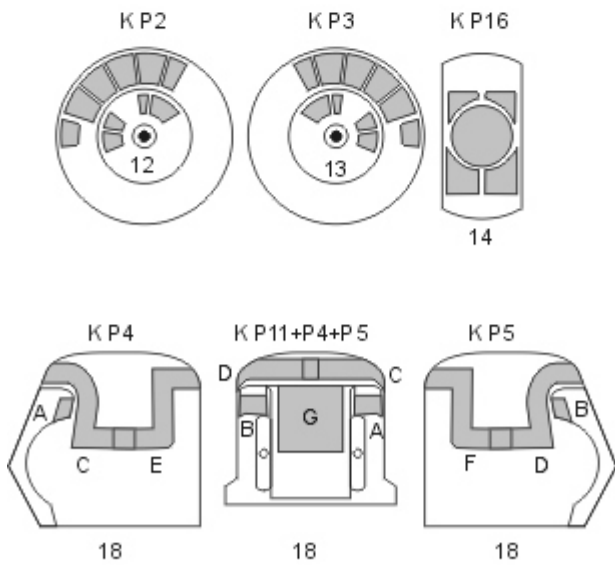
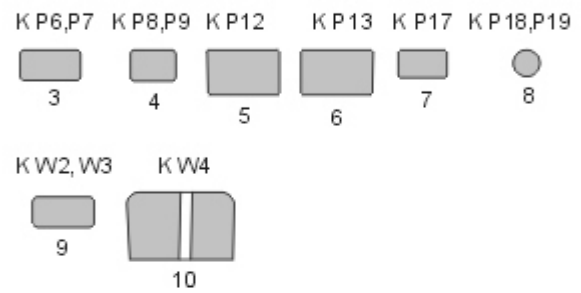
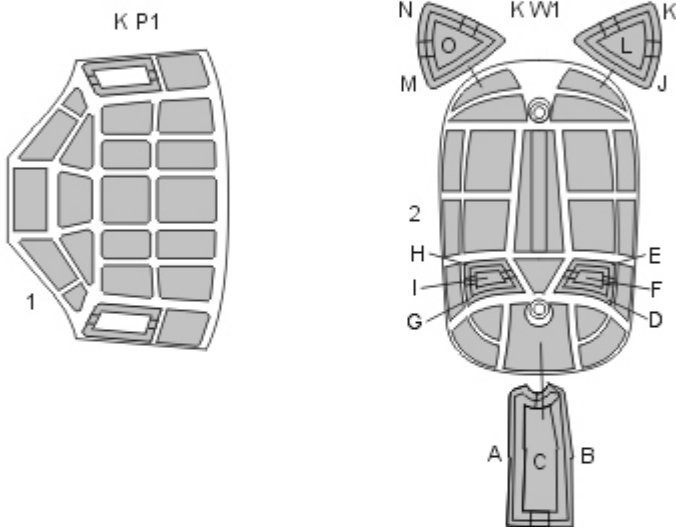

# NWAM1271

1/48 scale



F-14D Tomcat BASIC kabuki masks

for G.W.H No. L4834 kit

<http://mek.kosmo.cz/newware>

[tom.nwkits@seznam.cz](mailto:tom.nwkits@seznam.cz)

## Use also NWAM1152 1/48 F-14B EXHASUST NOZZLES kabuki masks

### Important:

Let the sprayed color dry before applying masks. Remove masks very carefully after painting.

Where the mask is divided into A and B parts, first apply part A, next part B.

The set does not include masks for all areas, so mask the rest with masking tape or liquid mask.

K kit part

^ start placing the mask from this point

Placing wet masks on wet surface is recommended, except those marked by **W**

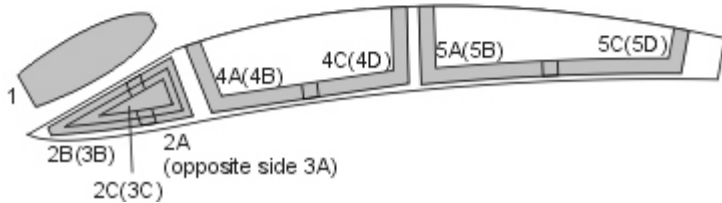
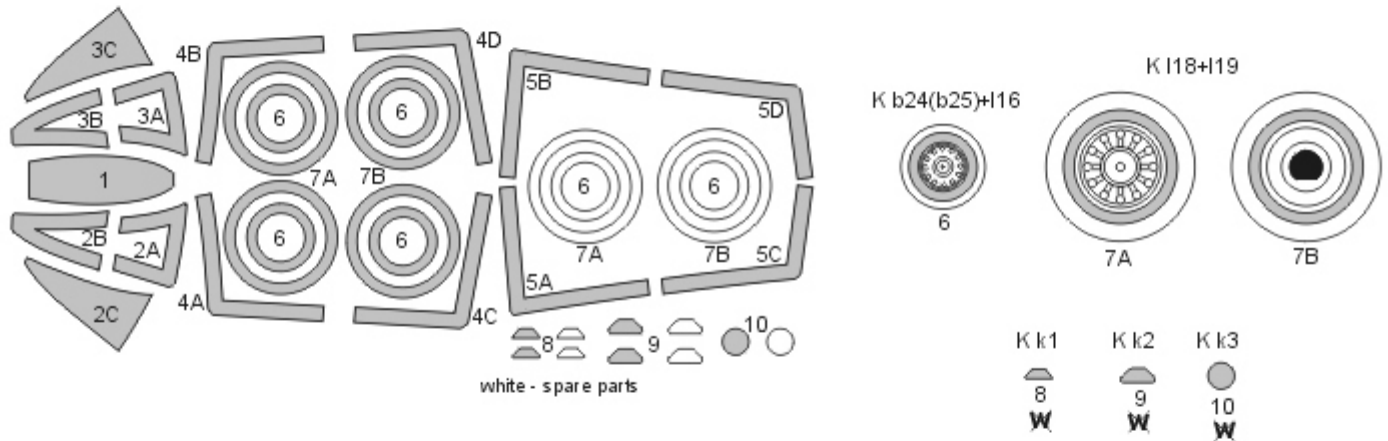

# NWAM1272

1/48 scale



## F-14D Tomcat EXPERT kabuki masks

for G.W.H No. L4834 kit

<http://mek.kosmo.cz/newware>

INCLUDES ALSO WINDOWS  
INNER SIDE MASKS

tom.nwkits@seznam.cz

### Use also NWAM1152 1/48 F-14B EXHASUST NOZZLES kabuki masks

#### Important:

Let the sprayed color dry before applying masks. Remove masks very carefully after painting.

Where the mask is divided into A and B parts, first apply part A, next part B.

The set does not include masks for all areas, so mask the rest with masking tape or liquid mask.

K kit part

\* start placing the mask from this point

Placing wet masks on wet surface is recommended, except those marked by **W**

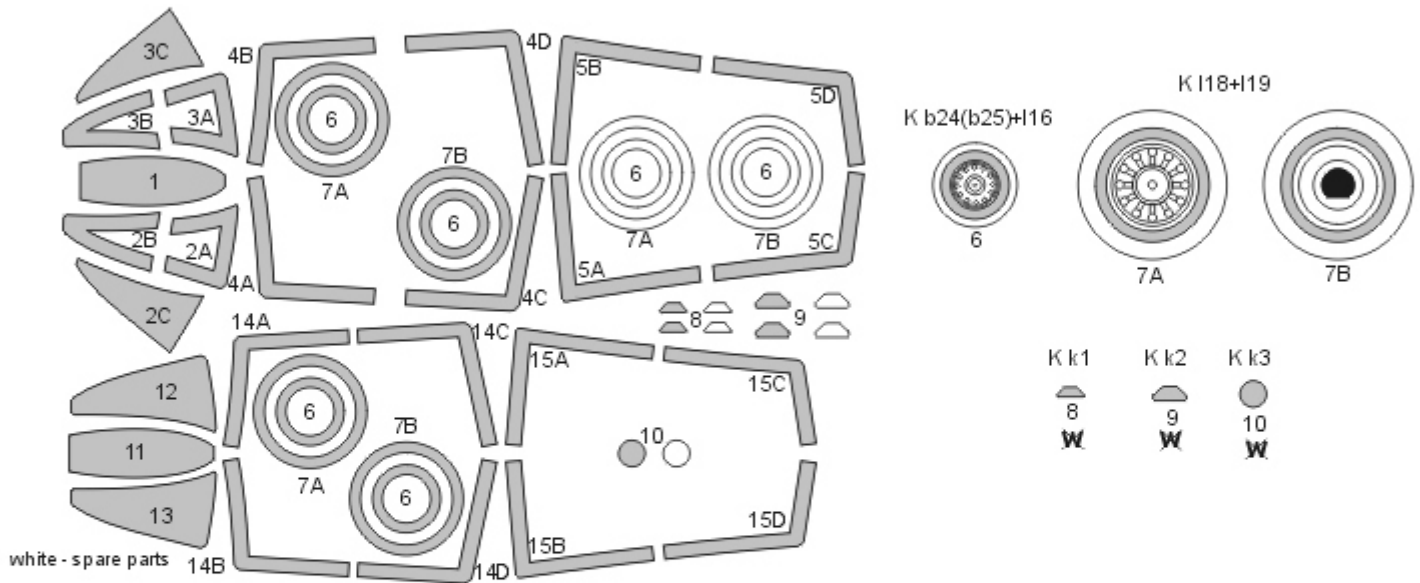

STEP 1 - exterior view  
mask interior, paint interior color

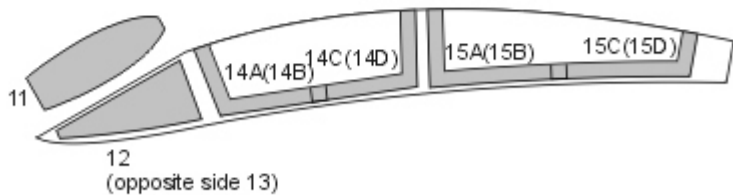

STEP 2  
mask exterior, paint camouflage color





## MH-60L Blackhawk BASIC kabuki masks

for ICM No. 48360 kit

<http://mek.kosmo.cz/newware>

tom.nwkits@seznam.cz

### Important:

Let the sprayed color dry before applying masks. Remove masks very carefully after painting.

Where the mask is divided into A and B parts, first apply part A, next part B.

The set does not include masks for all areas, so mask the rest with masking tape or liquid mask.

K kit part

\* start placing the mask from this point

Placing wet masks on wet surface is recommended, except those marked by **W**

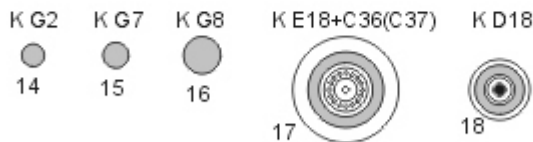
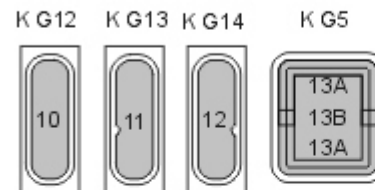
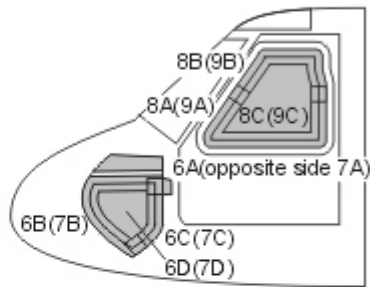
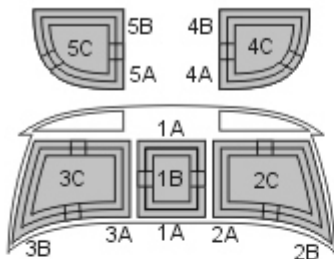
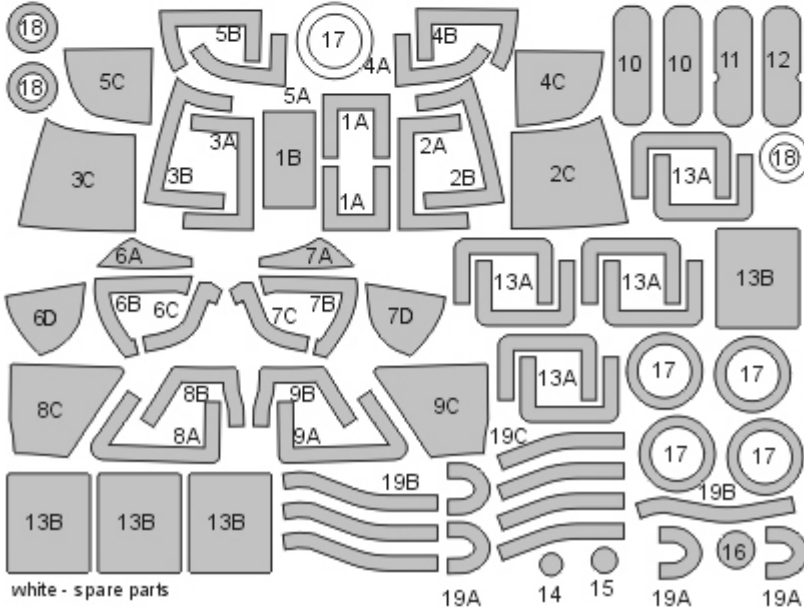



## MH-60L Blackhawk EXPERT kabuki masks

for ICMNo. 48360 kit

<http://mek.kosmo.cz/newware>

INCLUDES ALSO WINDOWS  
INNER SIDE MASKS

tom.nwkits@seznam.cz

**Important:**

Let the sprayed color dry before applying masks. Remove masks very carefully after painting.

Where the mask is divided into A and B parts, first apply part A, next part B.

The set does not include masks for all areas, so mask the rest with masking tape or liquid mask.

K kit part

\* start placing the mask from this point

Placing wet masks on wet surface is recommended, except those marked by **W**

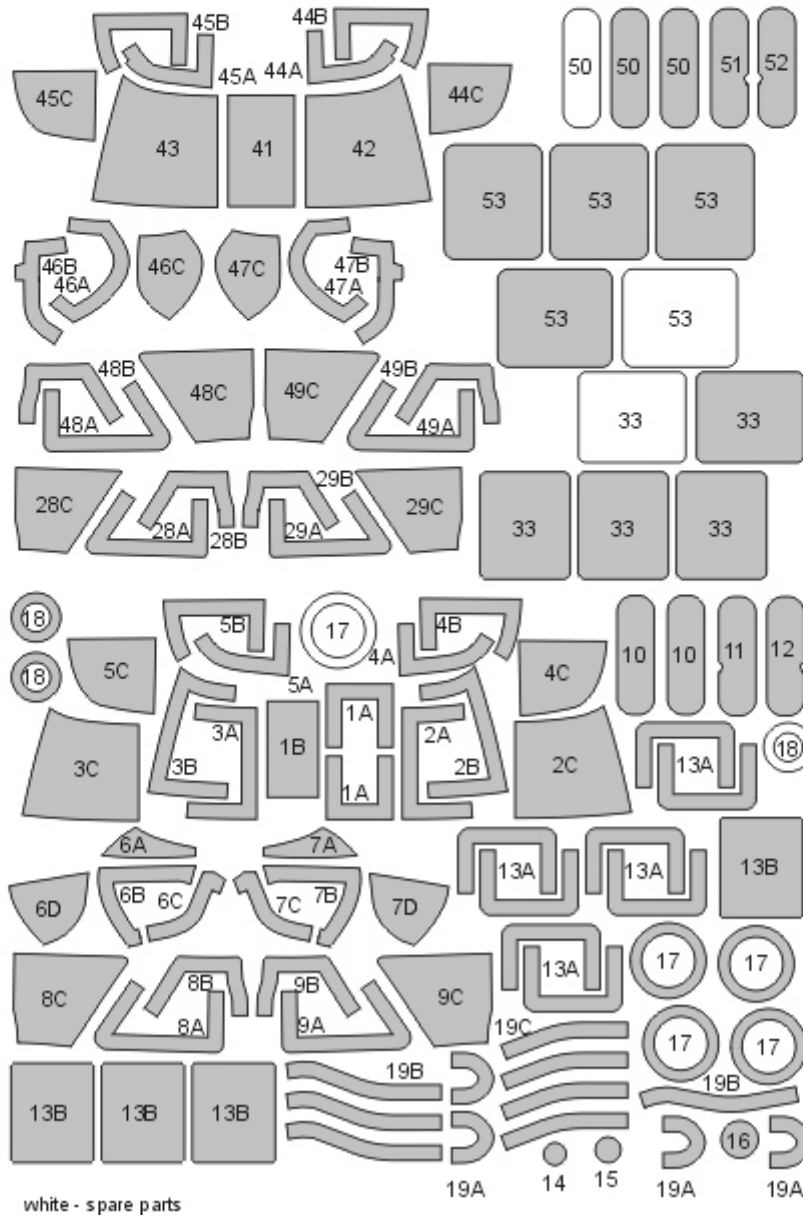

STEP 1 - exterior view  
mask interior, paint interior color

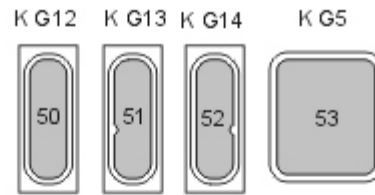
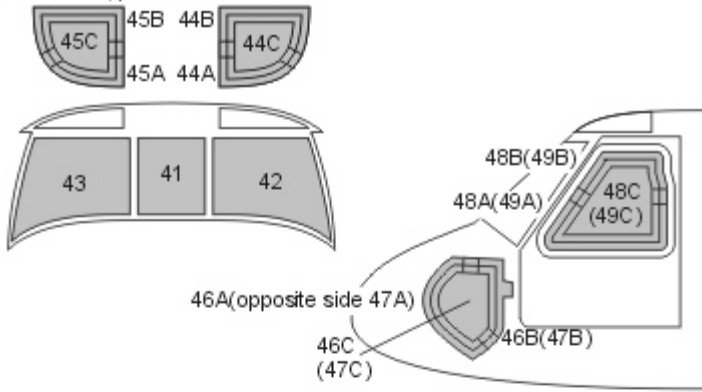

STEP 2  
mask exterior, paint seal color

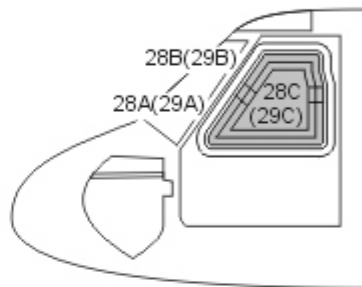

STEP 3  
mask exterior, paint camouflage color

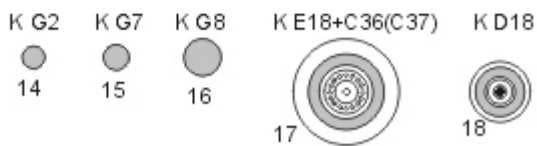
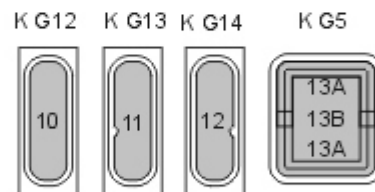
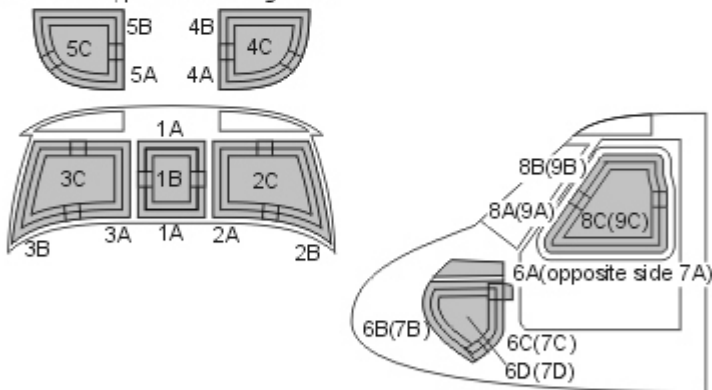





F-14D BASIC kabuki masks

for Academy no. 12590 kit

<http://mek.kosmo.cz/newware>

tom.nwkits@seznam.cz

**Important:**

Let the sprayed color dry before applying masks. Remove masks very carefully after painting.

Where the mask is divided into A and B parts, first apply part A, next part B.

The set does not include masks for all areas, so mask the rest with masking tape or liquid mask.

K kit part

\* start placing the mask from this point

Placing wet masks on wet surface is recommended, except those marked by **W**

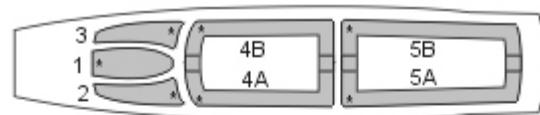
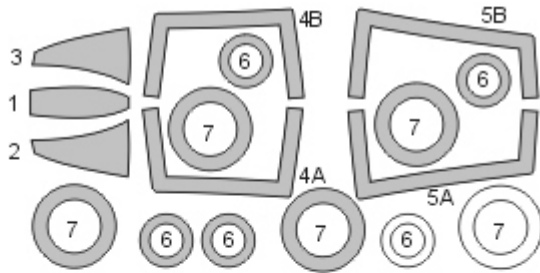

white - spare masks

K D5



K D8+F10



# NWAM1276



F-14D EXPERT kabuki masks  
for Academy no. 12590 and other kits  
<http://mek.kosmo.cz/newware>

INCLUDES ALSO WINDOWS INNER  
SIDE, CAMOUFLAGE AND EXHAUST  
NOZZLES MASKS

1/72 scale

tom.nwkits@seznam.cz

**Important:**

Let the sprayed color dry before applying masks. Remove masks very carefully after painting.  
Where the mask is divided into A and B parts, first apply part A, next part B.  
The set does not include masks for all areas, so mask the rest with masking tape or liquid mask.

K kit part

\* start placing the mask from this point

Placing wet masks on wet surface is recommended, except those marked by **W**

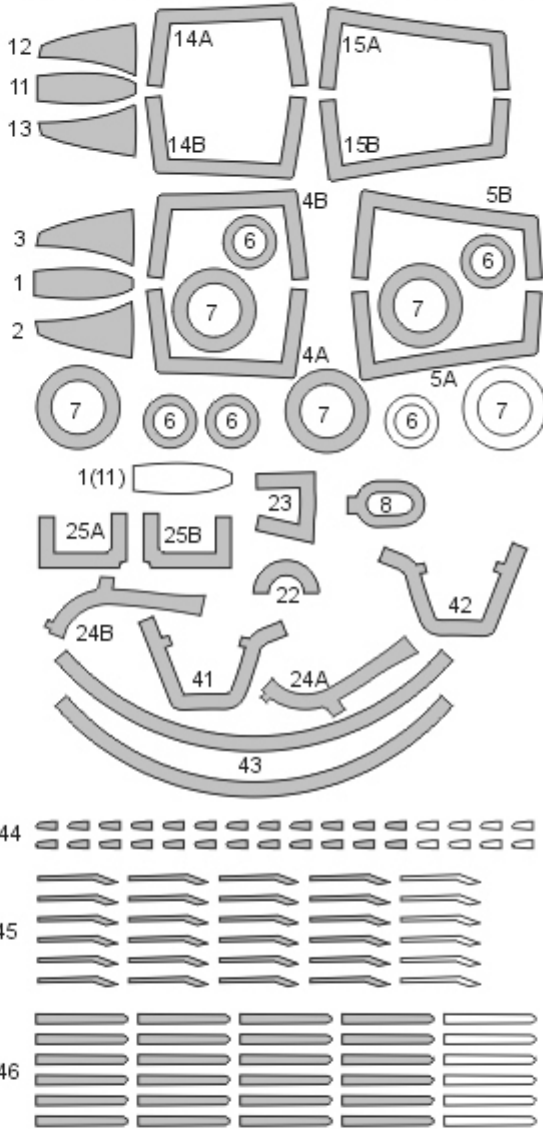

white - spare masks

STEP 1 - exterior view  
mask interior, paint interior color

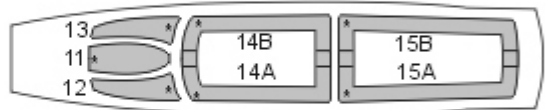

STEP 2  
mask exterior, paint camouflage color

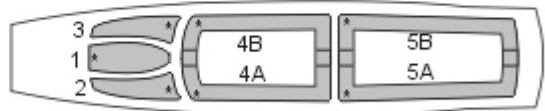

K C10(C9)+D17

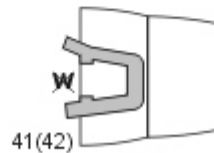

41(42)

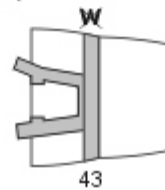

43

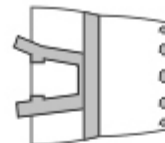

44

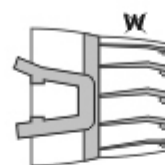

45

K D5



6

K D8+F10



7

K B13

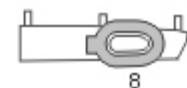

8

interior of the part D17  
paint white  
mask  
paint metallic color



46

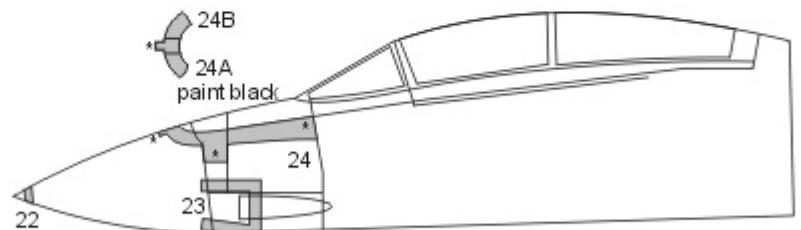
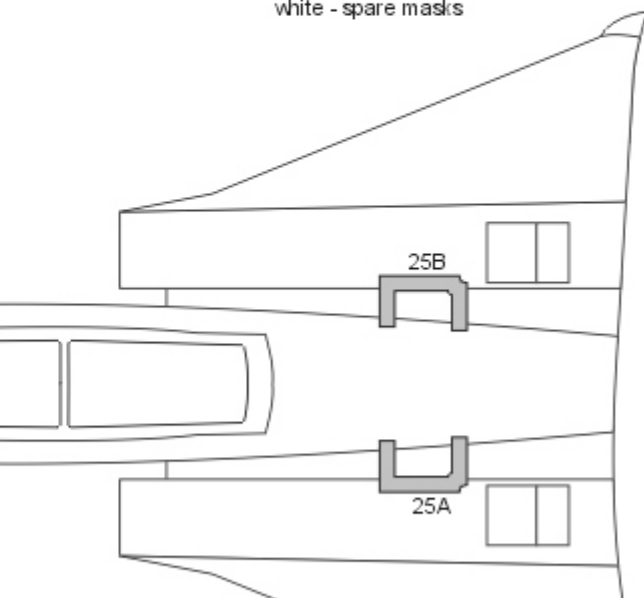

# NWAM1277

1/48 scale



## F-35C Lightning II BASIC kabuki masks

for Tamiya 61127 kit

<http://mek.kosmo.cz/newware>

tom.nwkits@seznam.cz

### USE ALSO NWAM1279 F-35C CAMOUFLAGE KABUKI MASKS

**Important:**

Let the sprayed color dry before applying masks. Remove masks very carefully after painting.

Where the mask is divided into A and B parts, first apply part A, next part B.

The set does not include masks for all areas, so mask the rest with masking tape or liquid mask.

K kit part

^ start placing the mask from this point

Placing wet masks on wet surface is recommended, except those marked by **W**

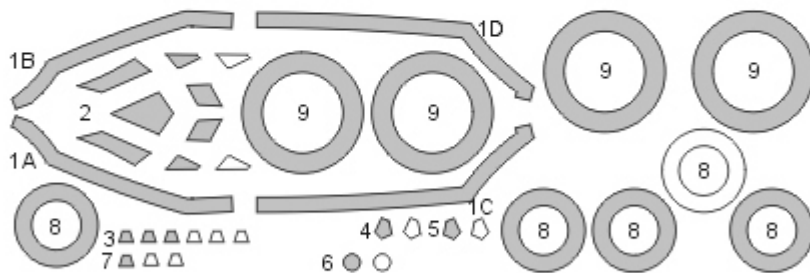

white - spare parts

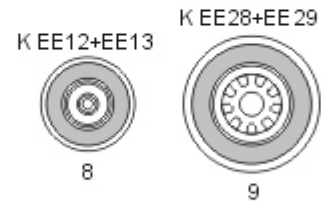
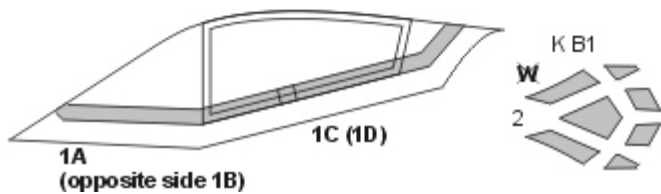

K B2, B8 replacement of the masking sticker (j)

K B3	K B4	K B5	K FF1
<b>W</b> △	<b>W</b> △	<b>W</b> △	<b>W</b> △
4	5	6	7

**W** △ 3



## F-35C Lightning II EXPERT kabuki masks

for Tamiya 61127 kit

<http://mek.kosmo.cz/newware>

tom.nwkits@seznam.cz

USE ALSO NWAM1279 F-35C CAMOUFLAGE KABUKI MASKS

**Important:**

Let the sprayed color dry before applying masks. Remove masks very carefully after painting.  
Where the mask is divided into A and B parts, first apply part A, next part B.  
The set does not include masks for all areas, so mask the rest with masking tape or liquid mask.

K kit part

\* start placing the mask from this point

Placing wet masks on wet surface is recommended, except those marked by **W**

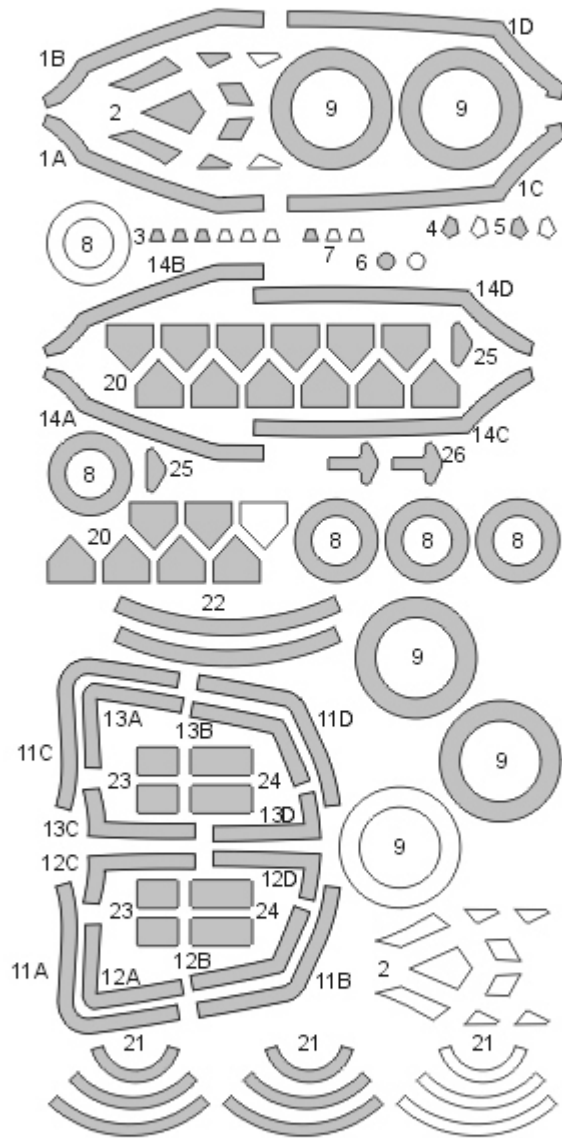

white - spare parts

K D3+D4  
GBU-31 JDAM



K D1

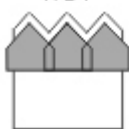

**W** 20

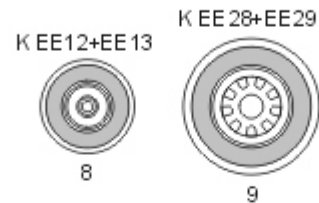

K B2, B8 replacement of the masking sticker **W** 3  
 K B3 **W** 4  
 K B4 **W** 5  
 K B5 **W** 6  
 K FF1 **W** 7

**STEP 1 - exterior view**  
mask interior, paint "Frame" color

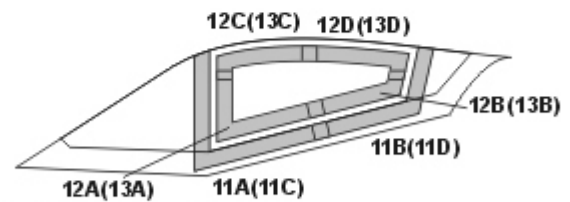

**STEP 2 - exterior view**  
mask interior, paint interior color

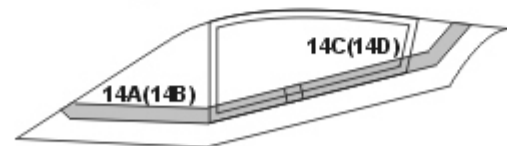

**STEP 3**  
mask exterior, paint camouflage color

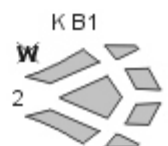
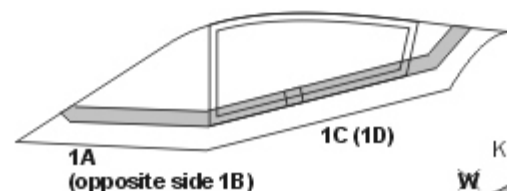



## F-35C Lightning II CAMOUFLAGE kabuki masks

for Tamiya 61127 kit

<http://mek.kosmo.cz/newware>

tom.nwkits@seznam.cz

USE ALSO NWAM1277 OR NWAM1278 F-35C KABUKI MASKS

**Important:**

Let the sprayed color dry before applying masks. Remove masks very carefully after painting.

Where the mask is divided into A and B parts, first apply part A, next part B.

The set does not include masks for all areas, so mask the rest with masking tape or liquid mask.

K kit part

\* start placing the mask from this point

Placing wet masks on wet surface is recommended, except those marked by **W**

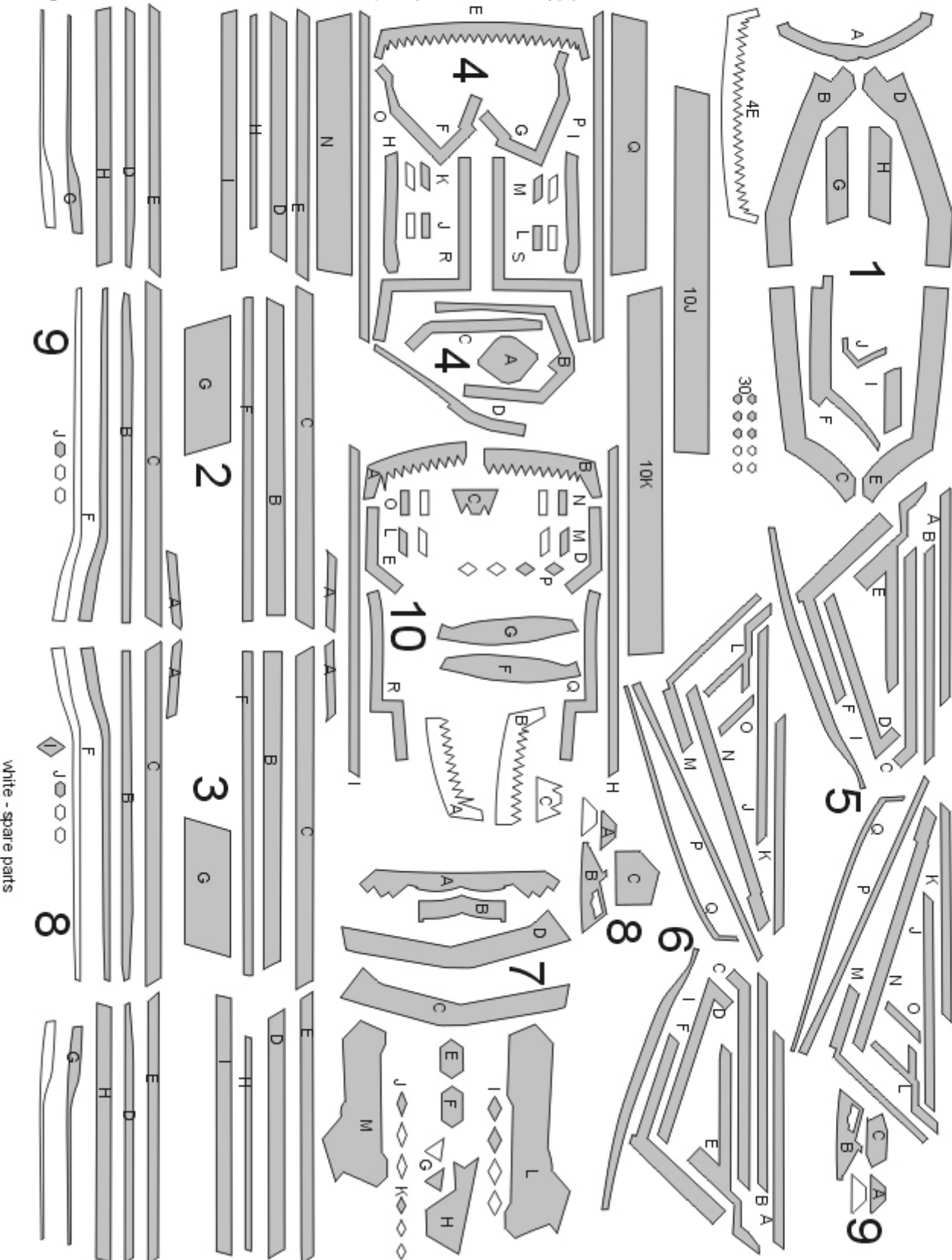

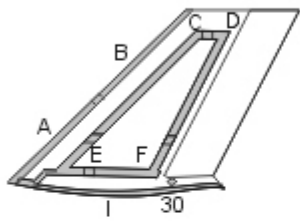
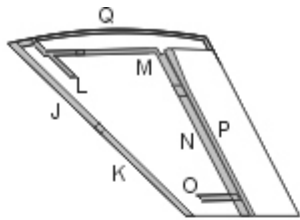

5

left rudder

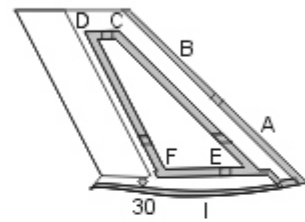
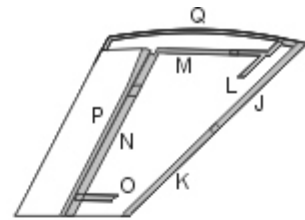

6

right rudder

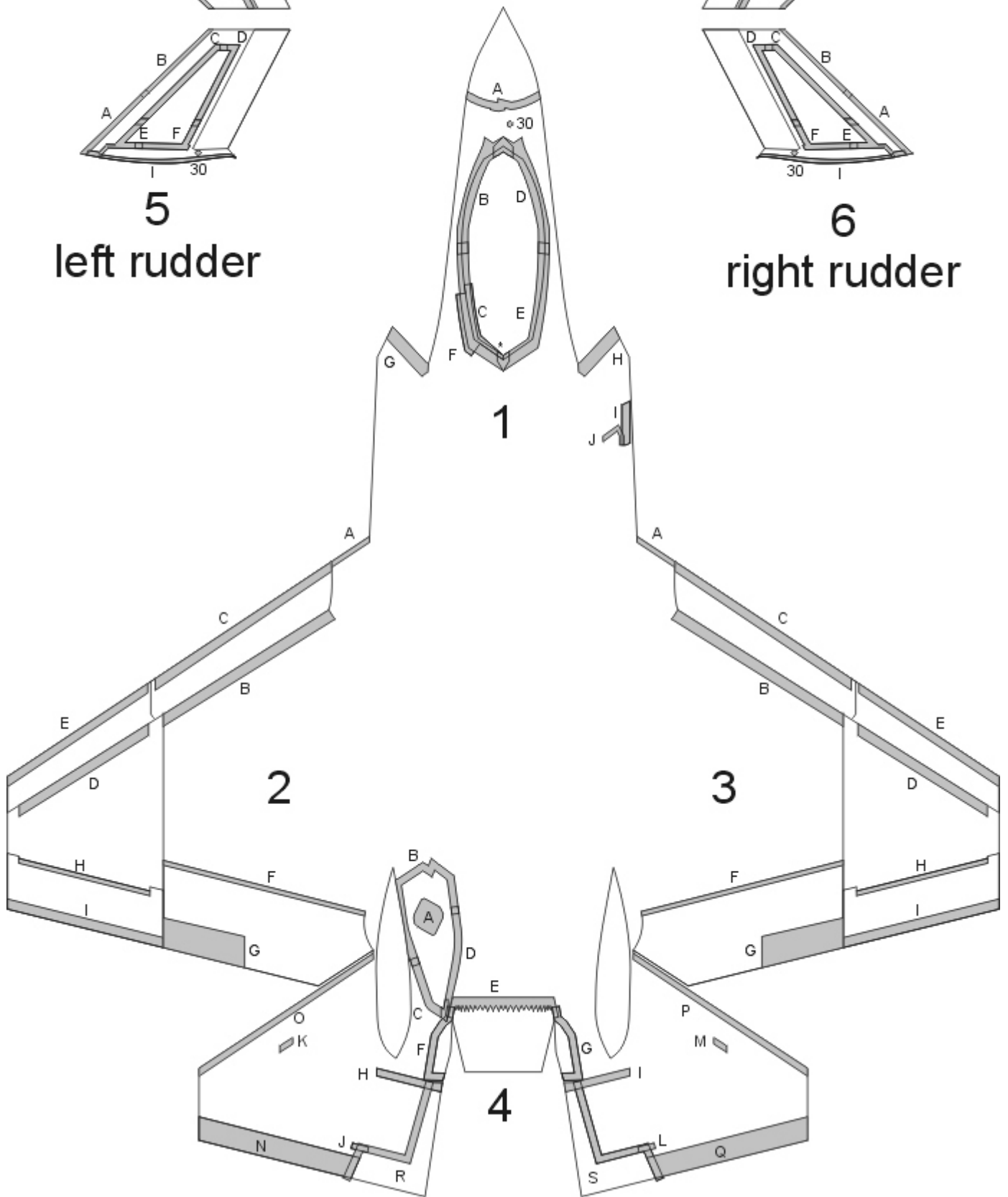

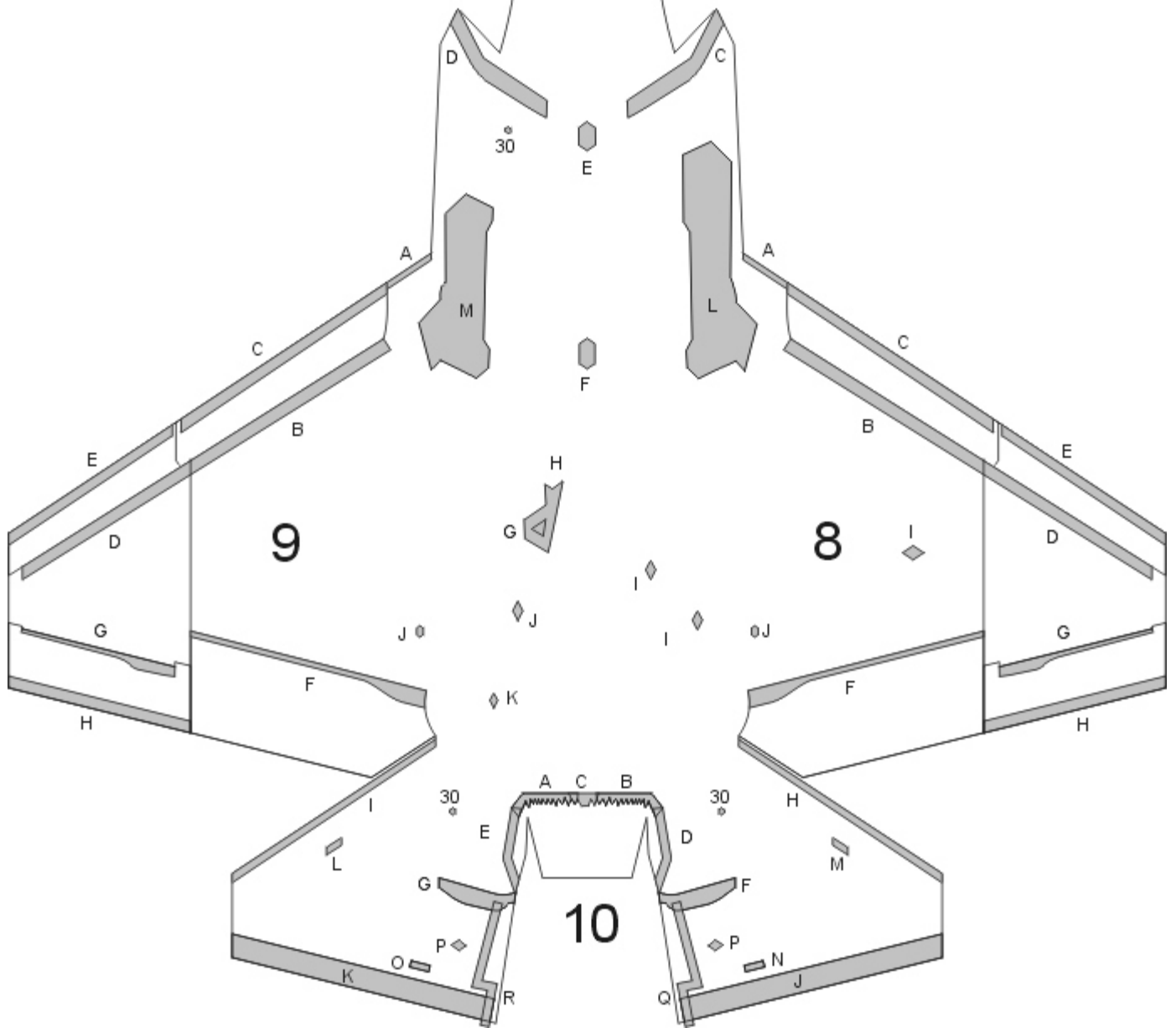
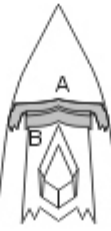
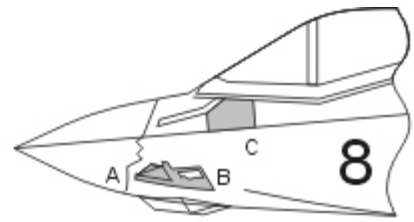
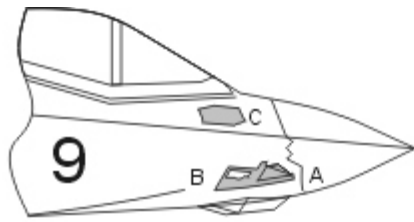



UH-60A Black Hawk BASIC kabuki masks

for ICM No. 48361, 48362 and other kits

<http://mek.kosmo.cz/newware>

tom.nwkits@seznam.cz

**Important:**

Let the sprayed color dry before applying masks. Remove masks very carefully after painting.

Where the mask is divided into A and B parts, first apply part A, next part B.

The set does not include masks for all areas, so mask the rest with masking tape or liquid mask.

K kit part

\* start placing the mask from this point

Placing wet masks on wet surface is recommended, except those marked by **W**

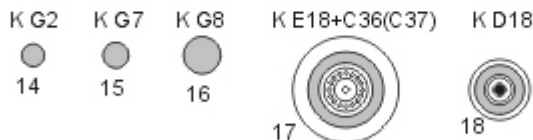
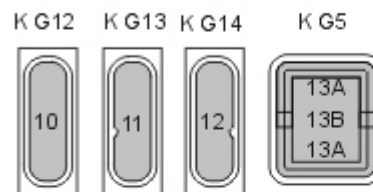
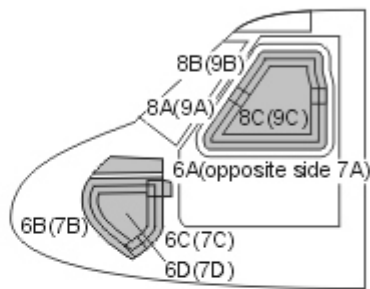
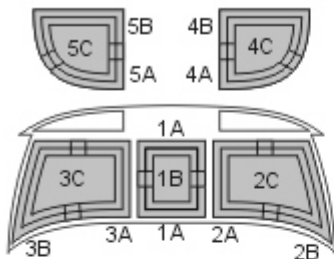
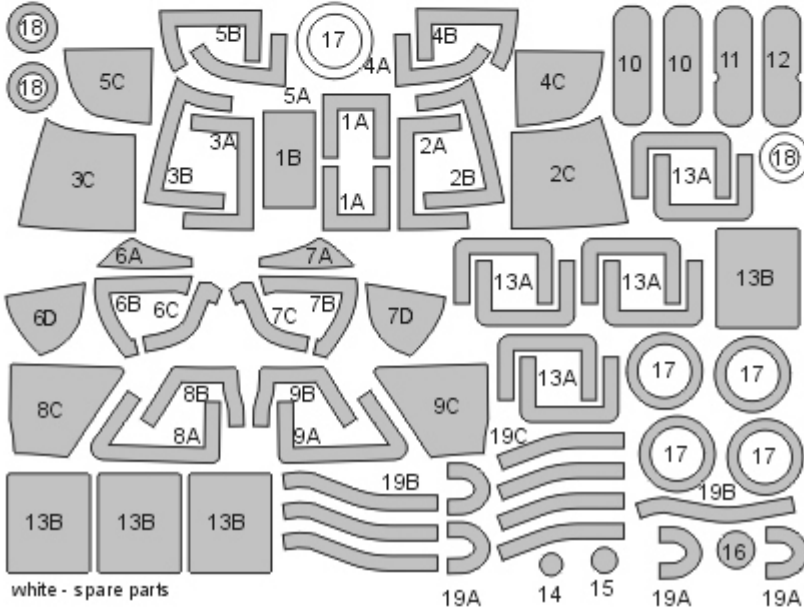





UH-60A Black Hawk EXPERT kabuki masks

for ICM No. 48361, 48362 and other kits

<http://mek.kosmo.cz/newware>

INCLUDES ALSO WINDOWS  
INNER SIDE MASKS

tom.nwkits@seznam.cz

**Important:**

Let the sprayed color dry before applying masks. Remove masks very carefully after painting.

Where the mask is divided into A and B parts, first apply part A, next part B.

The set does not include masks for all areas, so mask the rest with masking tape or liquid mask.

K kit part

\* start placing the mask from this point

Placing wet masks on wet surface is recommended, except those marked by **W**

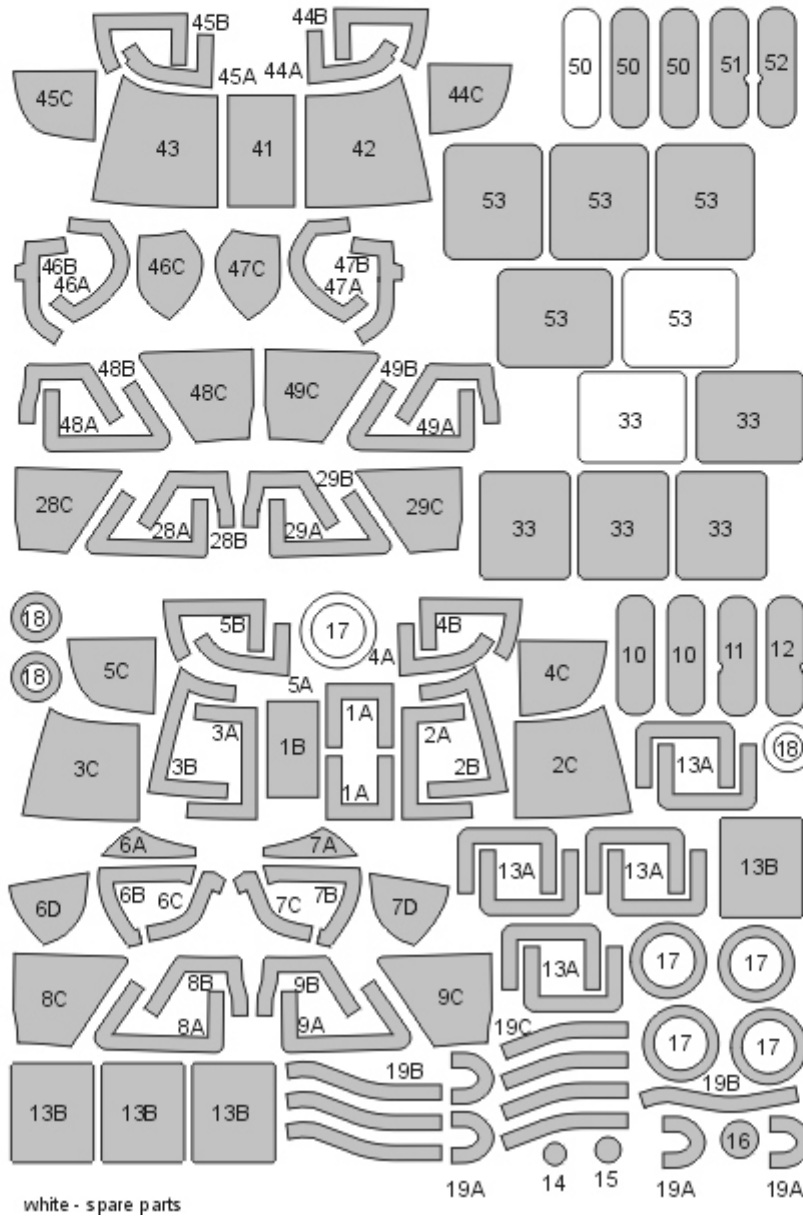

STEP 1 - exterior view  
mask interior, paint interior color

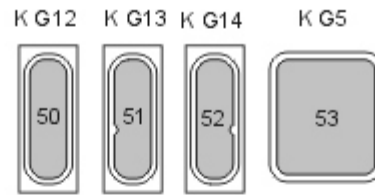
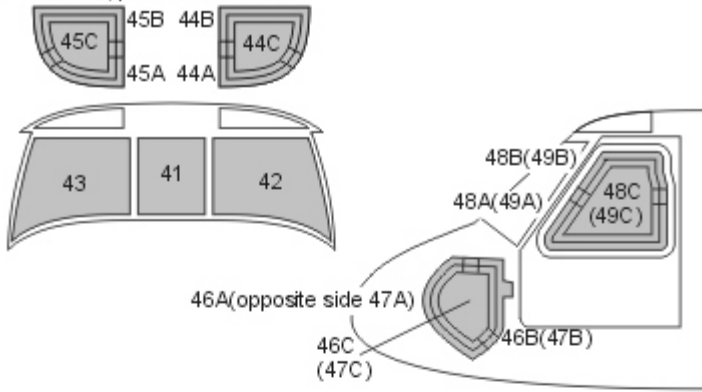

STEP 2  
mask exterior, paint seal color

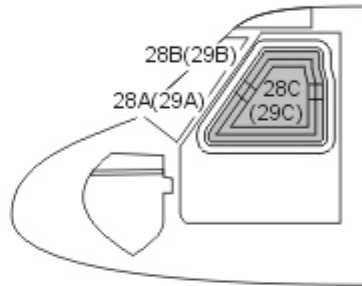

STEP 3  
mask exterior, paint camouflage color

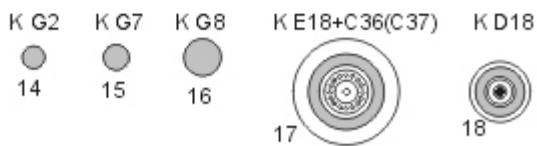
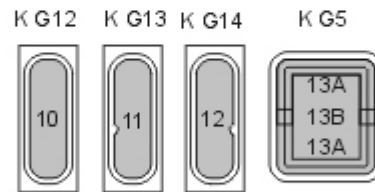
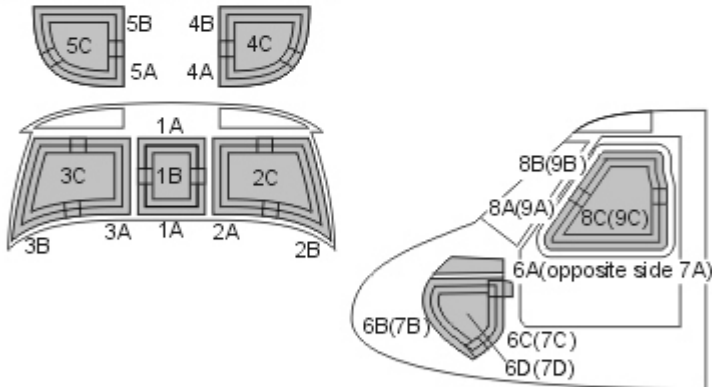



# NWAM1283

1/48 scale



Westland Sea King HC.4 EXPERT kabuki masks

for Airfix A11008 kit

<http://mek.kosmo.cz/newware>

INCLUDES ALSO WINDOWS  
INNER SIDE MASKS

tom.nwkits@seznam.cz

### Important:

Let the sprayed color dry before applying masks. Remove masks very carefully after painting.

Where the mask is divided into A and B parts, first apply part A, next part B.

The set does not include masks for all areas, so mask the rest with masking tape or liquid mask.

K kit part

^ start placing the mask from this point

Placing wet masks on wet surface is recommended, except those marked by **W**

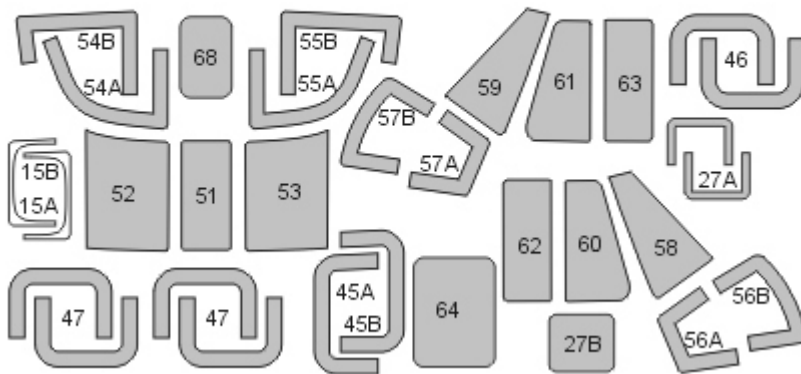
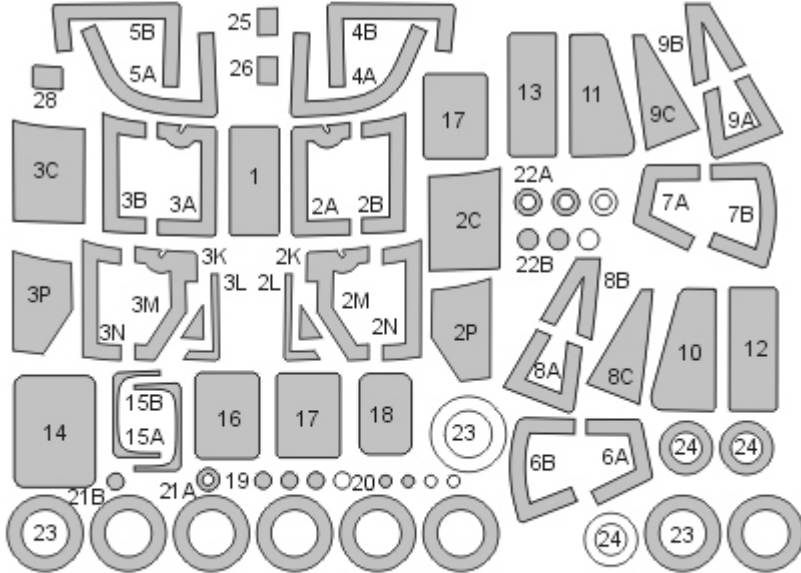

WHITE - SPARE MASKS

K X2, X3   K X4, X5   K X13   K X14   K X21



23

24

STEP 1 - exterior view  
mask interior  
paint camouflage color

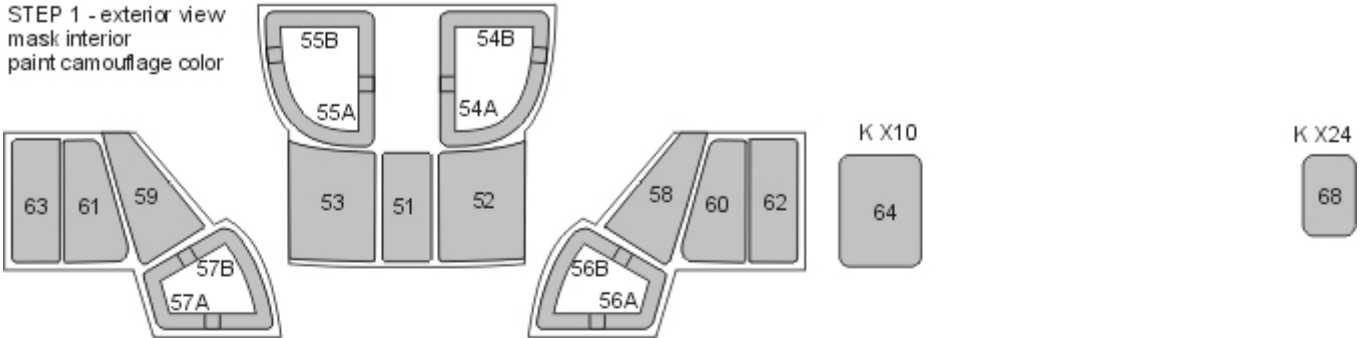

STEP 2  
mask exterior  
paint camouflage color

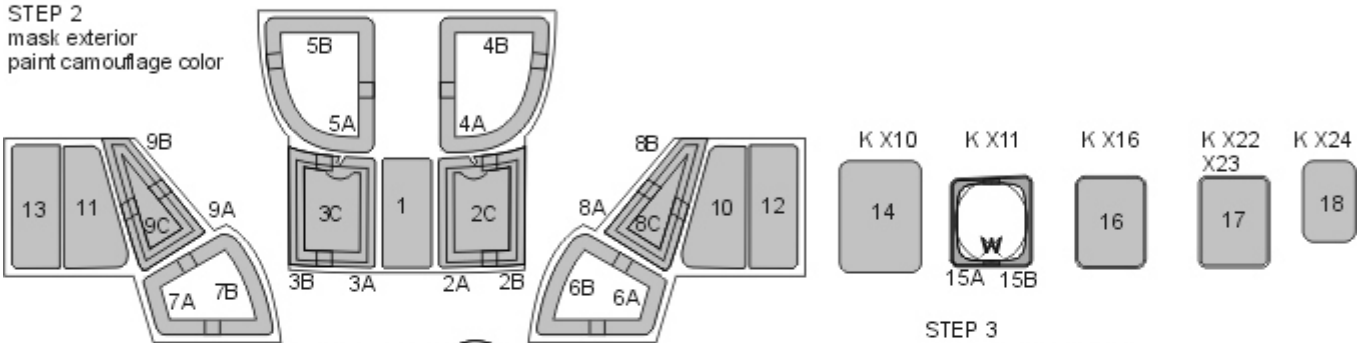

STEP 3  
paint seal color (black)

