



# NEW WARE NEWSLETTER

## NEW MASKS NOVEMBER 2024

NWAM 1251 1/72 Meteor F.8/ FR9 BASIC kabuki masks	Airfix
NWAM 1252 1/72 Meteor F.8/ FR9 EXPERT kabuki masks	Airfix
NWAM 1253 1/72 West and Sea King HC.4 HAR.3/ Mk.43 BASIC kabuki masks	Airfix
NWAM 1254 1/72 West and Sea King HC.4 HAR.3/ Mk.43 ADVANCED kabuki masks	Airfix
NWAM 1255 1/72 West and Sea King HC.4 HAR.3/ Mk.43 EXPERT kabuki masks	Airfix
NWAM 1256 1/48 Mi g-35 BASIC kabuki masks	HobbyBoss
NWAM 1257 1/48 Mi g-35 ADVANCED kabuki masks	HobbyBoss
NWAM 1258 1/48 Mi g-35 EXPERT kabuki masks	HobbyBoss
NWAM 1259 1/72 Savoia Marchetti S.55A kabuki masks	Dora Wings
NWAM 1260 1/72 Savoia Marchetti S.55 kabuki masks	Dora Wings
NWAM 1261 1/48 UH-1D BASIC kabuki masks	Italeri
NWAM 1262 1/48 UH-1D EXPERT kabuki masks	Italeri
NWAM 1263 1/72 Republic P-43 Lancer kabuki masks	Dora Wings



**Gloster Meteor F.8/FR.9 BASIC kabuki masks**  
 for Airfix A04067, A04064, A73015 and otherkits  
<http://mek.kosmo.cz/newware>

tom.nwkits@seznam.cz

**Important:**

Let the sprayed color dry before applying masks. Remove masks very carefully after painting.  
 Where the mask is divided into A and B parts, first apply part A, next part B.  
 The set does not include masks for all areas, so mask the rest with masking tape or liquid mask.

K kit part

\* start placing the mask from this point

Placing wet masks on wet surface is recommended, except those marked by **W**

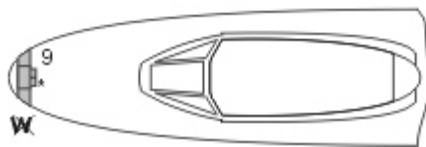
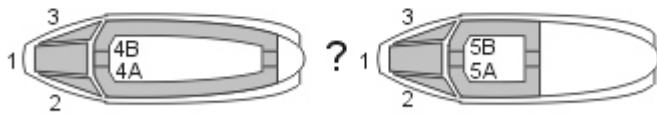

# NWAM1252

1/72 scale



**Gloster Meteor F.8/FR.9 EXPERT kabuki masks**  
for Airfix A04067, A04064, A73015 and otherkits  
<http://mek.kosmo.cz/newware>

Includes also windows  
inner side masks

[tom.nwkits@seznam.cz](mailto:tom.nwkits@seznam.cz)

### Important:

Let the sprayed color dry before applying masks. Remove masks very carefully after painting.  
Where the mask is divided into A and B parts, first apply part A, next part B.  
The set does not include masks for all areas, so mask the rest with masking tape or liquid mask.

K kit part

\* start placing the mask from this point

Placing wet masks on wet surface is recommended, except those marked by **W**

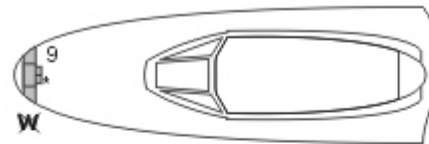
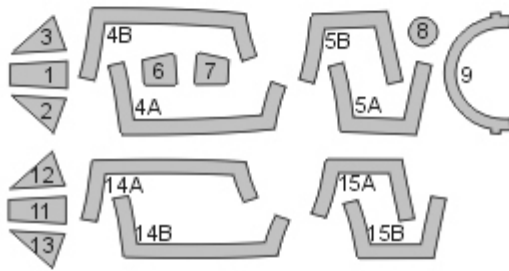

STEP 1 - exterior view  
mask interior, paint interior color



STEP 2  
mask exterior, paint camouflage color

?





Westland Sea King HC.4, HAR.3/Mk.43 BASIC kabuki masks

for Airfix A04056, A04056A, A04063 and other kits

<http://mek.kosmo.cz/newware>

tom.nwkits@seznam.cz

**Important:**

Let the sprayed color dry before applying masks. Remove masks very carefully after painting.  
 Where the mask is divided into A and B parts, first apply part A, next part B.  
 The set does not include masks for all areas, so mask the rest with masking tape or liquid mask.

K kit part

\* start placing the mask from this point

Placing wet masks on wet surface is recommended, except those marked by **W**

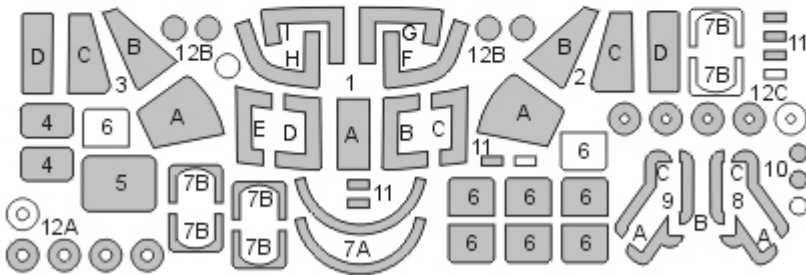

WHITE - SPARE MASKS

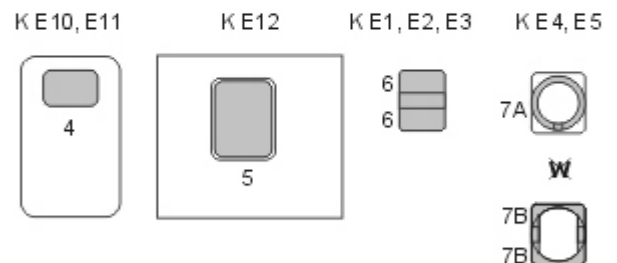
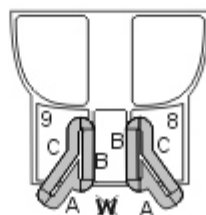
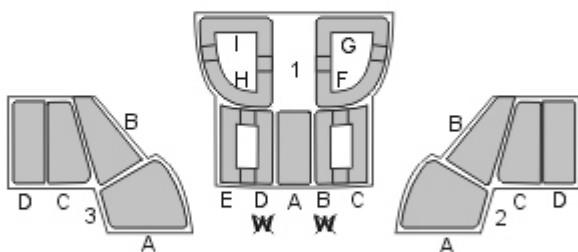
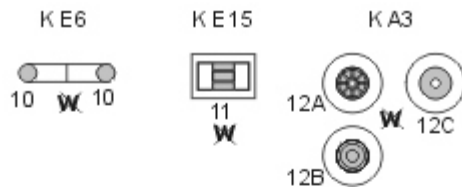

# NWAM1254

1/72 scale



Westland Sea King HC.4, HAR.3/Mk.43 ADVANCED kabuki masks

for Airfix A04056, A04056A, A04063 and other kits

<http://mek.kosmo.cz/newware>

Includes also windows  
seal masks

tom.nwkits@seznam.cz

**Important:**

Let the sprayed color dry before applying masks. Remove masks very carefully after painting.  
Where the mask is divided into A and B parts, first apply part A, next part B.  
The set does not include masks for all areas, so mask the rest with masking tape or liquid mask.

K kit part

\* start placing the mask from this point

Placing wet masks on wet surface is recommended, except those marked by **W**

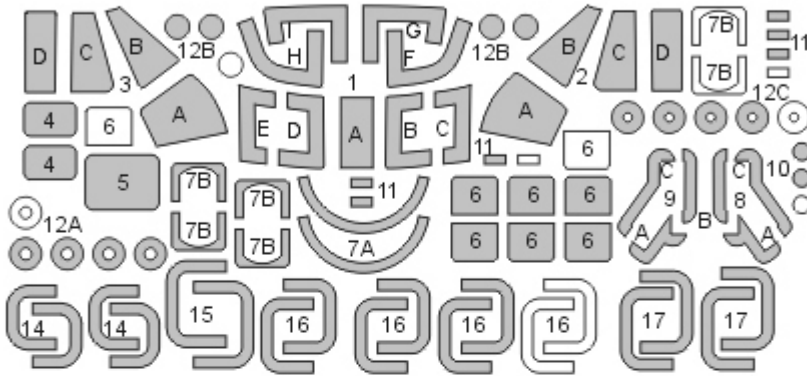

WHITE - SPARE MASKS

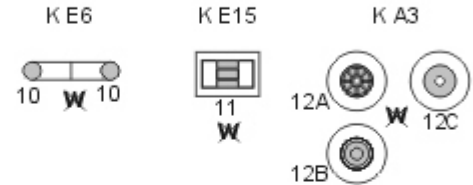

**STEP 1**  
mask exterior  
paint camouflage color

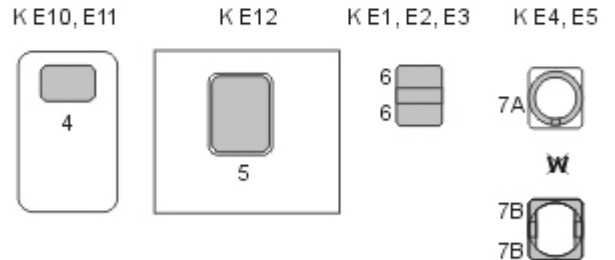
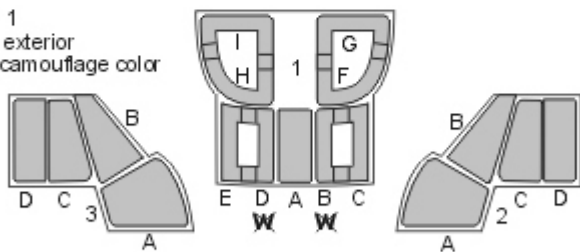

**STEP 2**  
paint seal color (black)

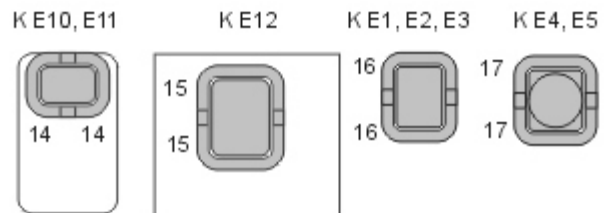
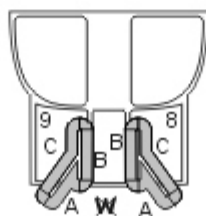

# NWAM1255



Westland Sea King HC.4, HAR.3/Mk.43 EXPERT kabuki masks  
for Airfix A04056, A04056A, A04063 and other kits  
<http://mek.kosmo.cz/newware>

Includes also windows  
seal and inner side masks

1/72 scale

tom.nwkits@seznam.cz

### Important:

Let the sprayed color dry before applying masks. Remove masks very carefully after painting.  
Where the mask is divided into A and B parts, first apply part A, next part B.  
The set does not include masks for all areas, so mask the rest with masking tape or liquid mask.

K kit part

\* start placing the mask from this point

Placing wet masks on wet surface is recommended, except those marked by **W**

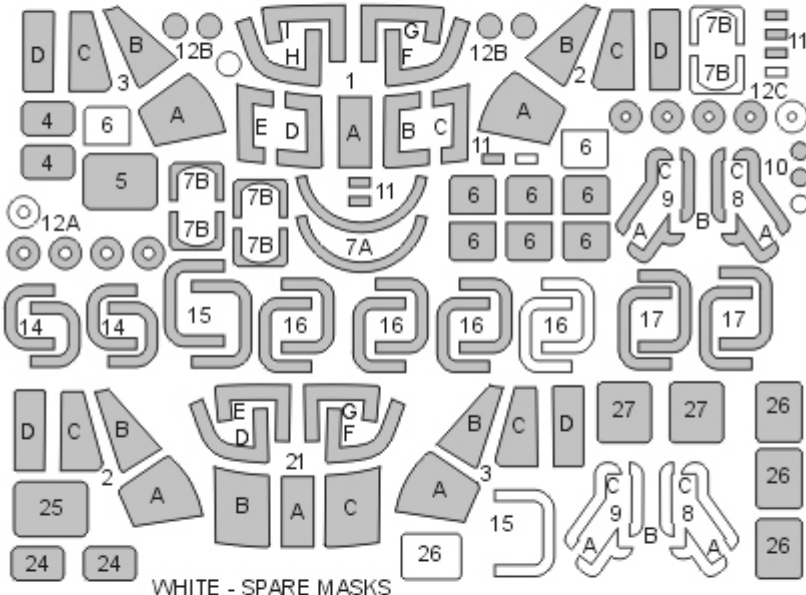

WHITE - SPARE MASKS

KE6

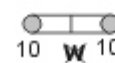

KE15



KA3

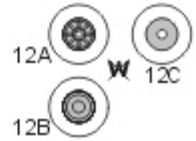

STEP 1 - exterior view  
mask interior  
paint camouflage color

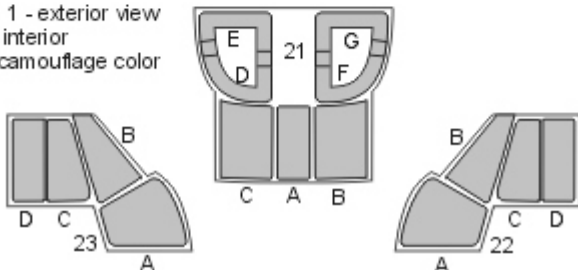

KE10, E11

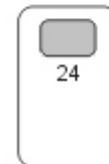

KE12

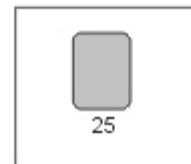

KE1, E2, E3



KE4, E5



STEP 2  
mask exterior  
paint camouflage color

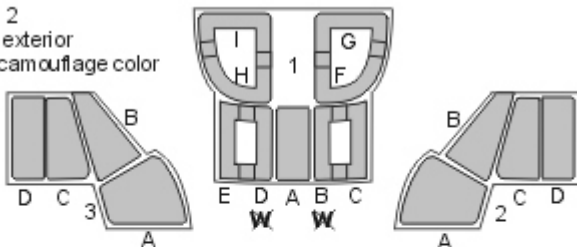

KE10, E11

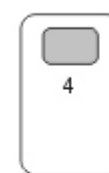

KE12

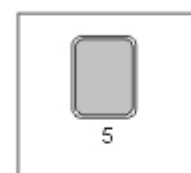

KE1, E2, E3



KE4, E5



STEP 3  
paint seal color (black)

KE10, E11

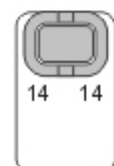

KE12

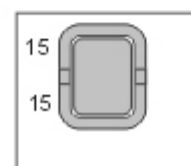

KE1, E2, E3

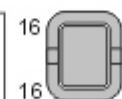

KE4, E5





MiG-35 BASIC kabuki masks

for HobbyBoss 81787 kit

<http://mek.kosmo.cz/newware>

tom.nwkits@seznam.cz

**Important:**

Let the sprayed color dry before applying masks. Remove masks very carefully after painting.  
 Where the mask is divided into A and B parts, first apply part A, next part B.  
 The set does not include masks for all areas, so mask the rest with masking tape or liquid mask.

K kit part

^ start placing the mask from this point

Placing wet masks on wet surface is recommended, except those marked by **W**

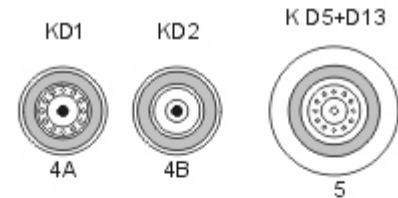
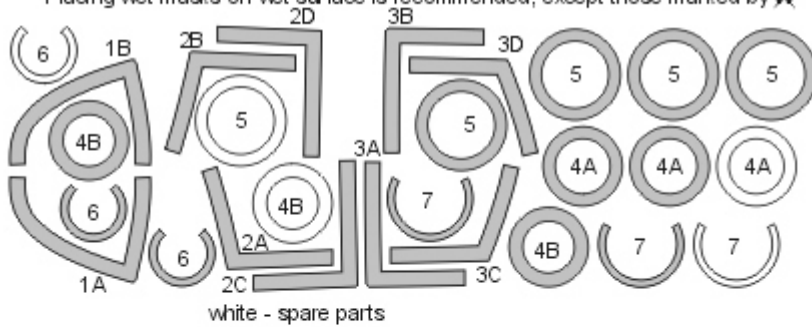

K J9      K J10

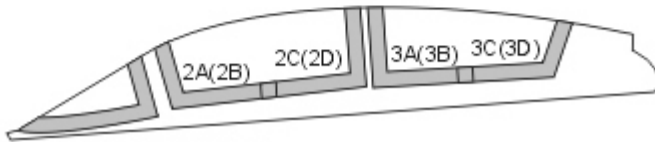

1A(opposite side 1B)

# NWAM1257



MiG-35 ADVANCED kabuki masks  
for HobbyBoss 81787 kit  
<http://mek.kosmo.cz/newware>

INCLUDES ALSO  
WINDOWS SEAL  
AND CAMOUFLAGE DETAILS MASKS

1/48 scale

[tom.nwkits@seznam.cz](mailto:tom.nwkits@seznam.cz)

### Important:

Let the sprayed color dry before applying masks. Remove masks very carefully after painting.  
Where the mask is divided into A and B parts, first apply part A, next part B.  
The set does not include masks for all areas, so mask the rest with masking tape or liquid mask.

K kit part

\* start placing the mask from this point

Placing wet masks on wet surface is recommended, except those marked by **W**

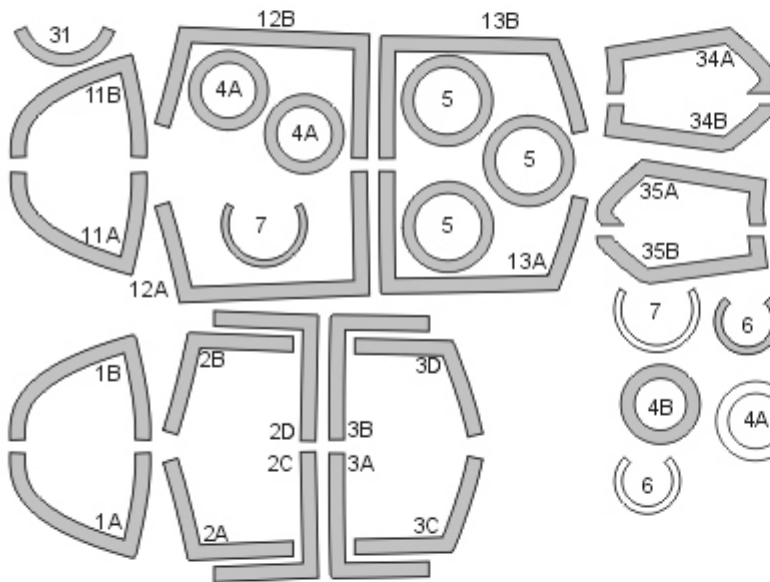

STEP 1  
paint interior color



STEP 2  
paint seal color

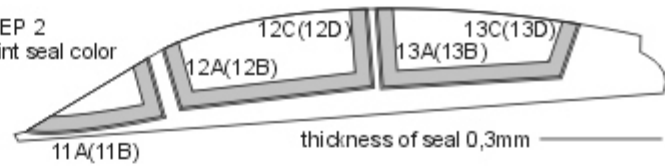

STEP 3  
paint camouflage color

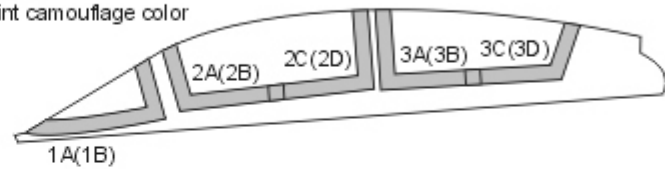

white - spare parts

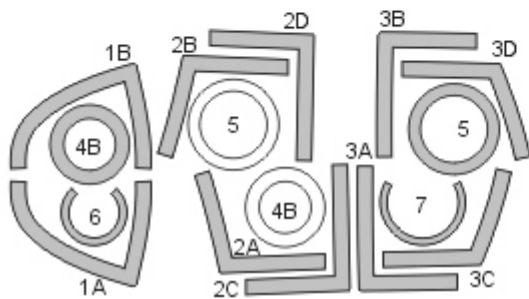

K J9 K J10



KD1

KD2

K D5+D13

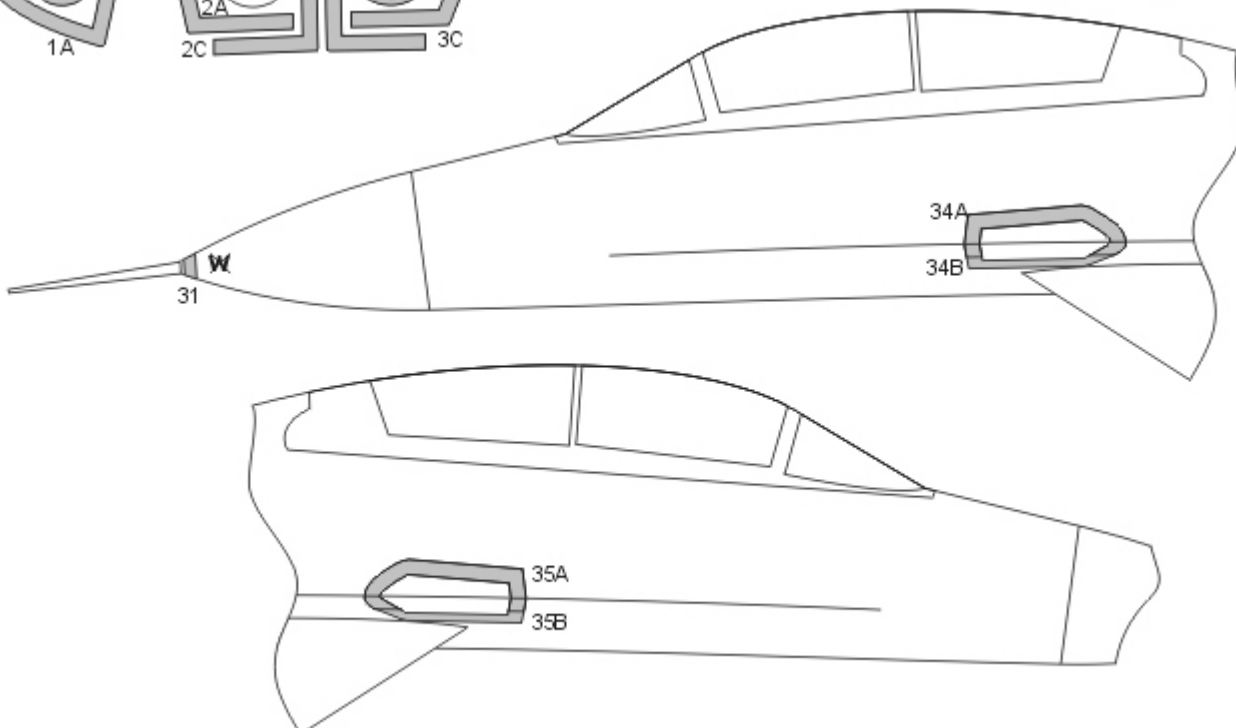
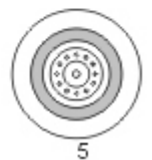
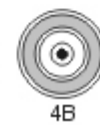



# NWAM1258



MiG-35 EXPERT kabuki masks

for HobbyBoss 81787 kit

[http://mek.kosmo.cz/new\\_ware](http://mek.kosmo.cz/new_ware)

INCLUDES ALSO  
WINDOWS SEAL AND INNER SIDE MASKS  
AND CAMOUFLAGE DETAILS MASKS

1/48 scale

tom.nwkits@seznam.cz

### Important:

Let the sprayed color dry before applying masks. Remove masks very carefully after painting.  
Where the mask is divided into A and B parts, first apply part A, next part B.  
The set does not include masks for all areas, so mask the rest with masking tape or liquid mask.

K kit part

\* start placing the mask from this point

Placing wet masks on wet surface is recommended, except those marked by **W**

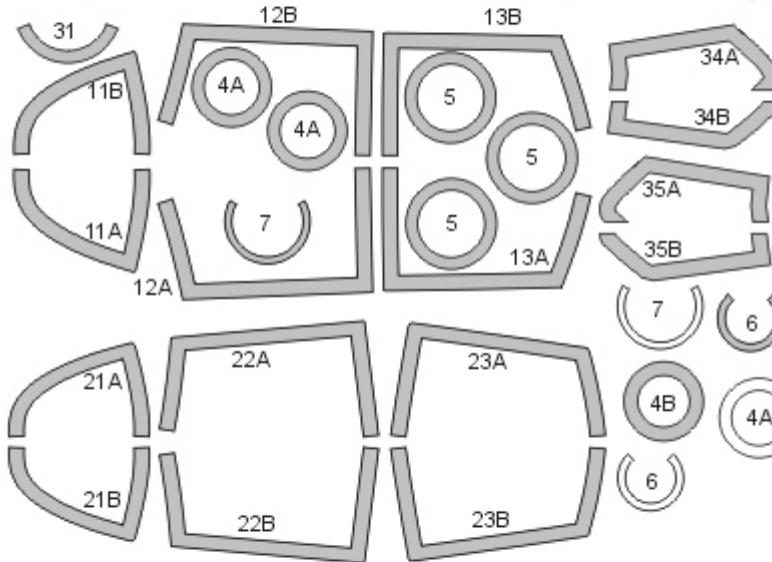

STEP 1 - exterior view  
mask interior, paint interior color



STEP 2  
mask exterior, paint seal color

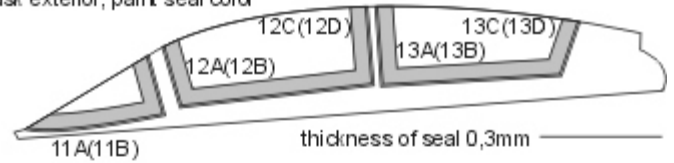

STEP 3  
mask exterior, paint camouflage color



white - spare parts

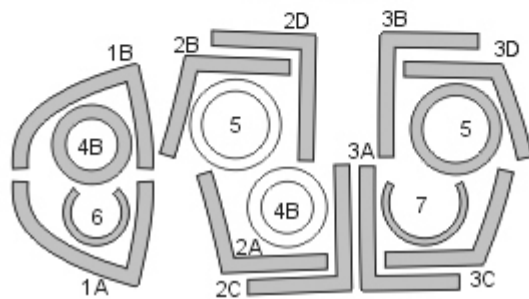

K J9 K J10



KD1

KD2

K D5+D13

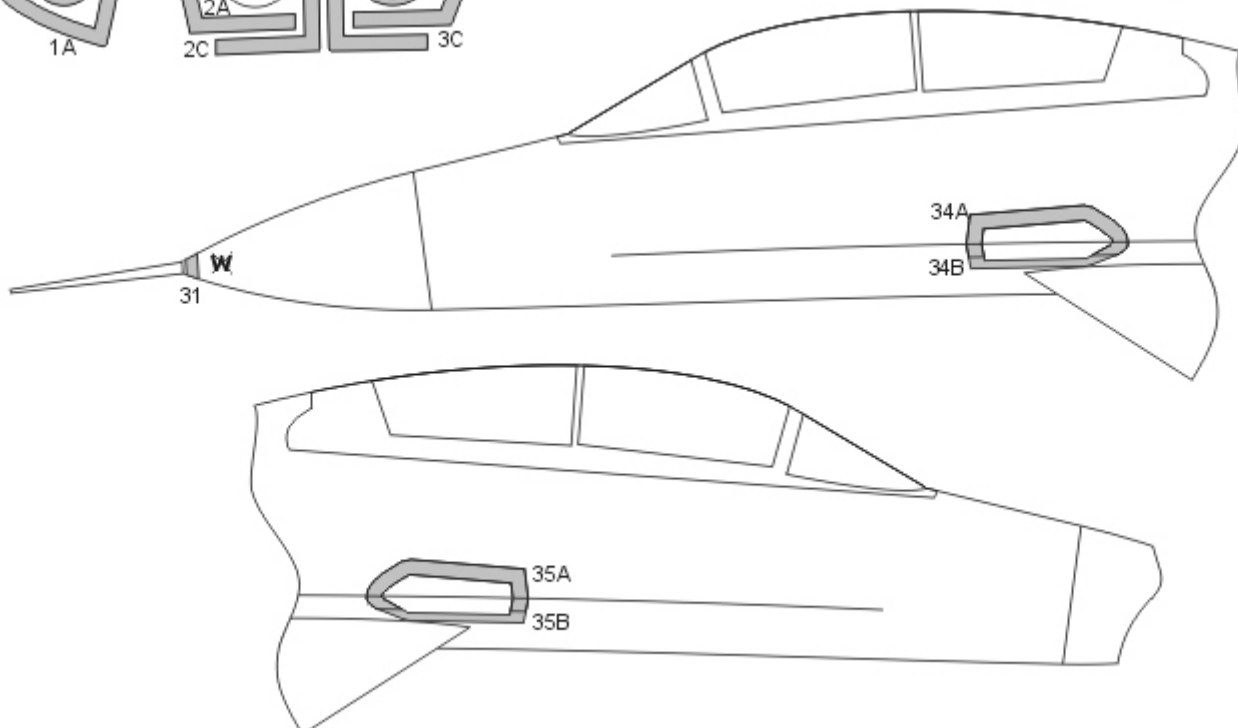
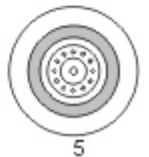



Savoia-Marchetti S.55A kabuki masks

for Dora Wings DW72018 kit

<http://mek.kosmo.cz/newware>

tom.nwkits@seznam.cz

**Important:**

Let the sprayed color dry before applying masks. Remove masks very carefully after painting.

Where the mask is divided into A and B parts, first apply part A, next part B.

The set does not include masks for all areas, so mask the rest with masking tape or liquid mask.

K kit part

^ start placing the mask from this point

Placing wet masks on wet surface is recommended, except those marked by **W**

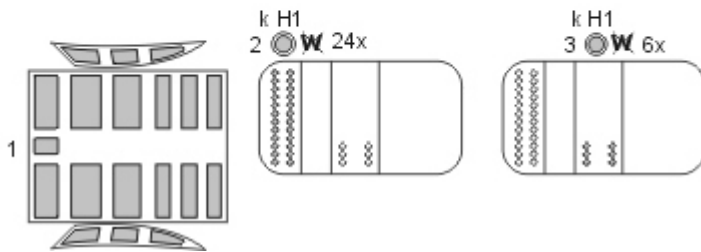
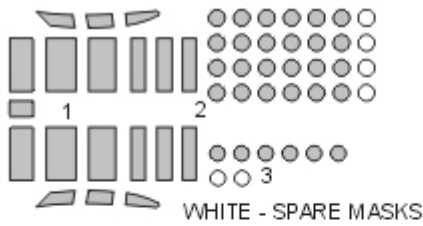

# NWAM1260

1/72 scale



Savoia-Marchetti S.55 kabuki masks  
for Dora Wings DW72015 and DW72020 kits

<http://mek.kosmo.cz/newware>

tom.nwkits@seznam.cz

### Important:

Let the sprayed color dry before applying masks. Remove masks very carefully after painting.  
Where the mask is divided into A and B parts, first apply part A, next part B.  
The set does not include masks for all areas, so mask the rest with masking tape or liquid mask.

K kit part

^ start placing the mask from this point

Placing wet masks on wet surface is recommended, except those marked by **W**

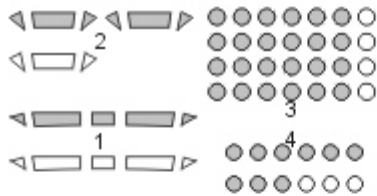

WHITE - SPARE MASKS



k H1  
3 ● **W** 24x



k H1, H6, H7  
4 ● **W** 9x





## UH-1D BASIC kabuki masks

for Italeri 849, 2621, 2739 and Revell 04452 kits

<http://mek.kosmo.cz/newware>

tom.nwkits@seznam.cz

### Important:

Let the sprayed color dry before applying masks. Remove masks very carefully after painting.

Where the mask is divided into A and B parts, first apply part A, next part B.

The set does not include masks for all areas, so mask the rest with masking tape or liquid mask.

K kit part

\* start placing the mask from this point

Placing wet masks on wet surface is recommended, except those marked by **W**

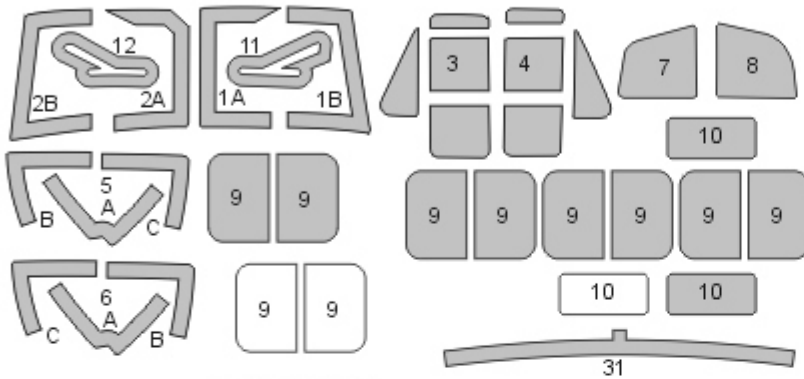

white - spare parts

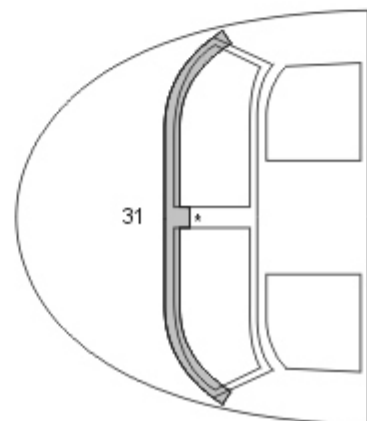
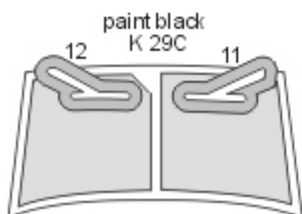
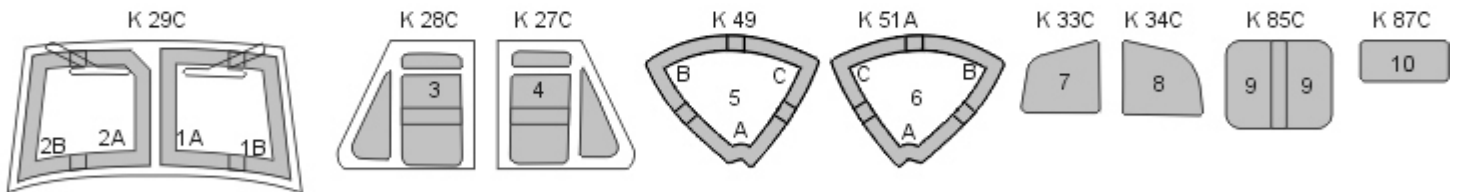



## UH-1D EXPERT kabuki masks

for Italeri 849, 2621, 2739 and Revell 04452 kits

<http://mek.kosmo.cz/newware>

tom.nwkits@seznam.cz

### Important:

Let the sprayed color dry before applying masks. Remove masks very carefully after painting.

Where the mask is divided into A and B parts, first apply part A, next part B.

The set does not include masks for all areas, so mask the rest with masking tape or liquid mask.

K kit part

\* start placing the mask from this point

Placing wet masks on wet surface is recommended, except those marked by **W**

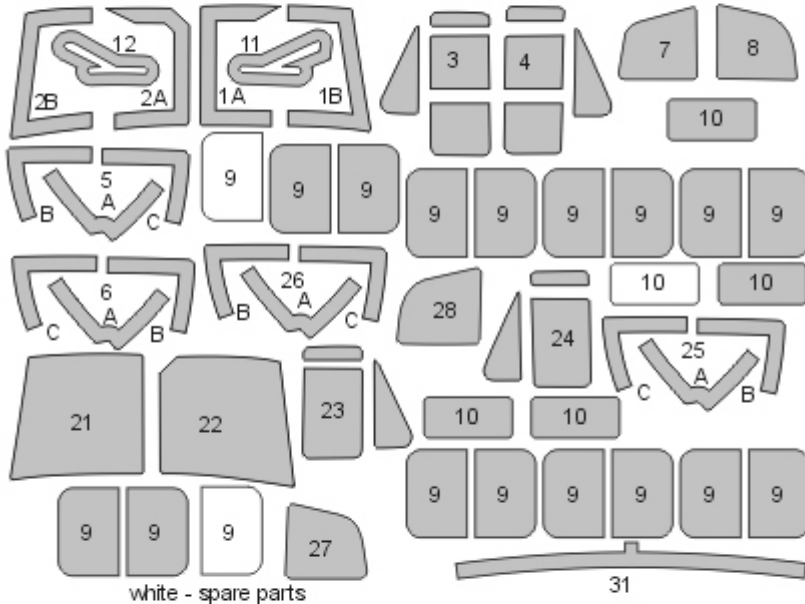

### STEP 1 - exterior view

mask interior, paint interior color

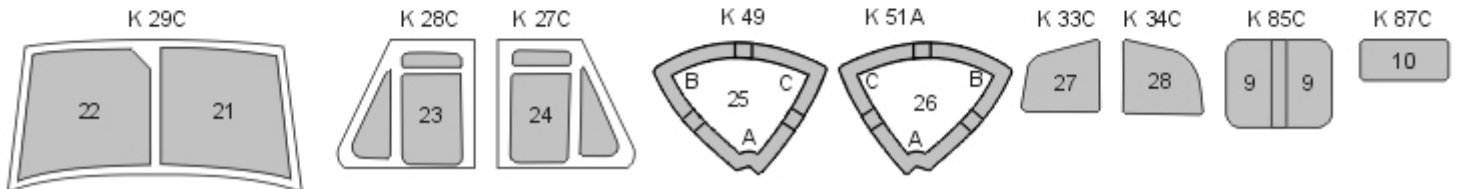

### STEP 2

mask exterior, paint camouflage color

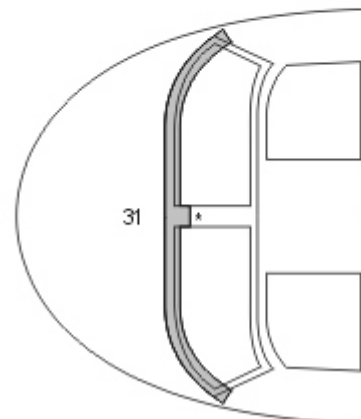
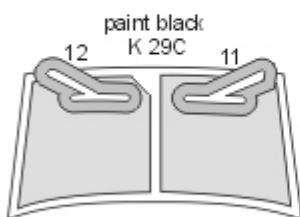
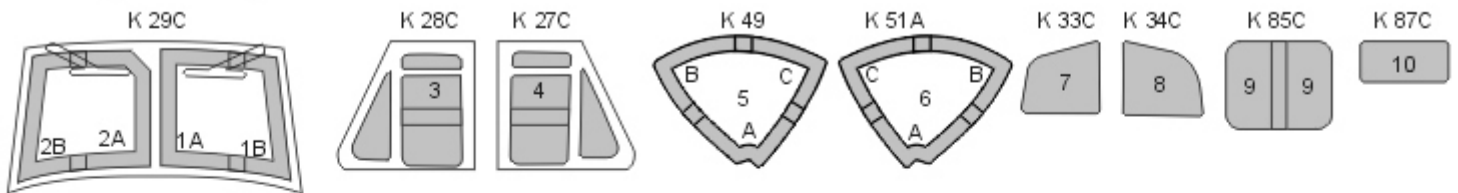

# NWAM1263

1/72 scale



Republic P-43 Lancer kabuki masks

for Dora Wings DW72027, DW72029, DW72031 and other kits

<http://mek.kosmo.cz/newware>

tom.nwkits@seznam.cz

### Important:

Let the sprayed color dry before applying masks. Remove masks very carefully after painting.

Where the mask is divided into A and B parts, first apply part A, next part B.

The set does not include masks for all areas, so mask the rest with masking tape or liquid mask.

K kit part

^ start placing the mask from this point

Placing wet masks on wet surface is recommended, except those marked by **W**

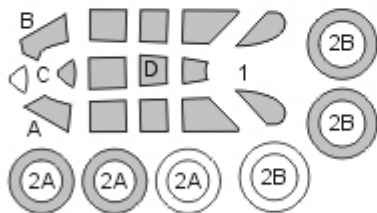

WHITE - SPARE MASKS

