



NEW WARE NEWSLETTER

NEW MASKS OCTOBER 2024

NWAM 1240 1/48 A-4M Skyhawk BASIC kabuki masks	Magic Factory
NWAM 1241 1/48 A-4M Skyhawk EXPERT kabuki masks	Magic Factory
NWAM 1242 1/72 Chinook HC.1 BASIC kabuki masks	Airfix
NWAM 1243 1/72 Chinook HC.1 ADVANCED kabuki masks	Airfix
NWAM 1244 1/48 Wyvern S.4 (early version) ADVANCED kabuki masks	Trumpeter
NWAM 1245 1/48 Wyvern S.4 (early version) EXPERT kabuki masks	Trumpeter
NWAM 1246 1/48 A-4B/C Skyhawk BASIC kabuki masks	Hobby 2000
NWAM 1247 1/48 A-4B/C Skyhawk EXPERT kabuki masks	Hobby 2000
NWAM 1248 1/48 A-4B/C Skyhawk grey+ white CAMOUFLAGE kabuki masks	Hobby 2000
NWAM 1249 1/48 UH-1Y Venom BASIC kabuki masks	Kitty Hawk
NWAM 1250 1/48 UH-1Y Venom EXPERT kabuki masks	Kitty Hawk



A-4M Skyhawk BASIC kabuki masks
for Magic Factory 5002 kit
<http://mek.kosmo.cz/newware>

tom.nwkits@seznam.cz

Important:

Let the sprayed color dry before applying masks. Remove masks very carefully after painting.
 Where the mask is divided into A and B parts, first apply part A, next part B.
 The set does not include masks for all areas, so mask the rest with masking tape or liquid mask.

K kit part

* start placing the mask from this point

Placing wet masks on wet surface is recommended, except those marked by **W**

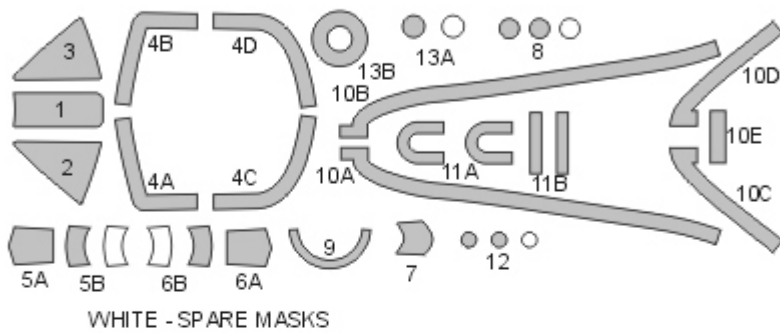

WHITE - SPARE MASKS

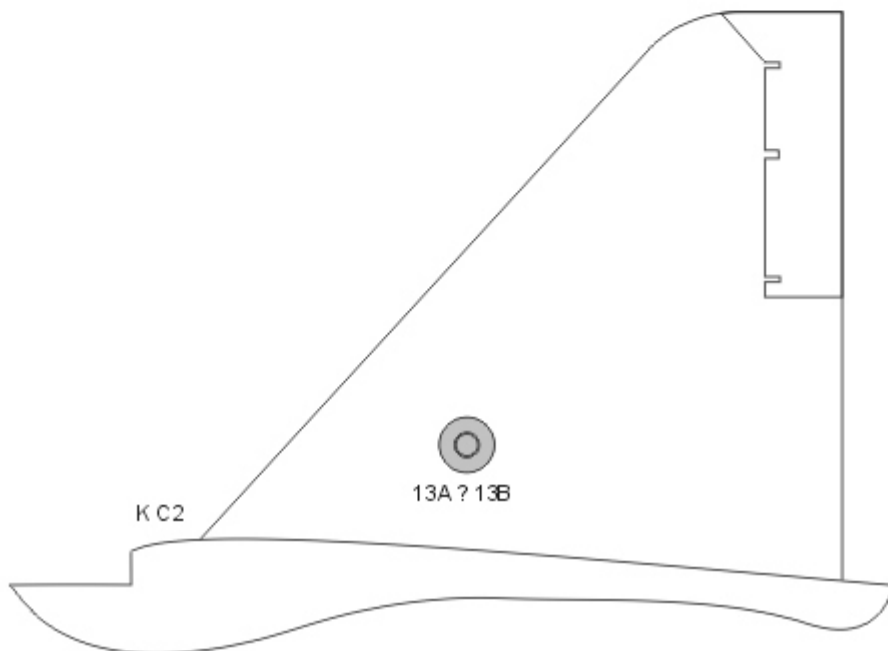
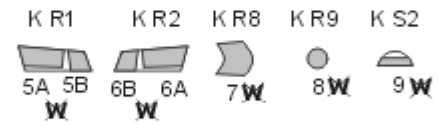
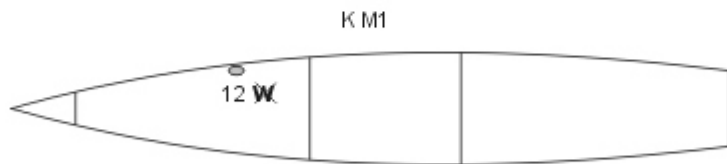
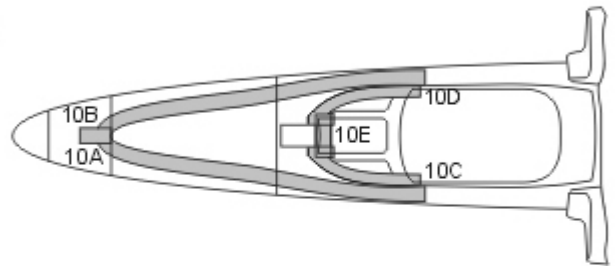
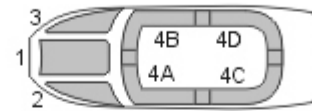
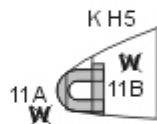

NWAM1241

1/48 scale



A-4M Skyhawk EXPERT kabuki masks
for Magic Factory 5002 kit
<http://mek.kosmo.cz/newware>

Includes also windows
inner side and bombs
yellow stripes masks

tom.nwkits@seznam.cz

Important:

Let the sprayed color dry before applying masks. Remove masks very carefully after painting.
Where the mask is divided into A and B parts, first apply part A, next part B.
The set does not include masks for all areas, so mask the rest with masking tape or liquid mask.
K kit part
^ start placing the mask from this point
Placing wet masks on wet surface is recommended, except those marked by **W**

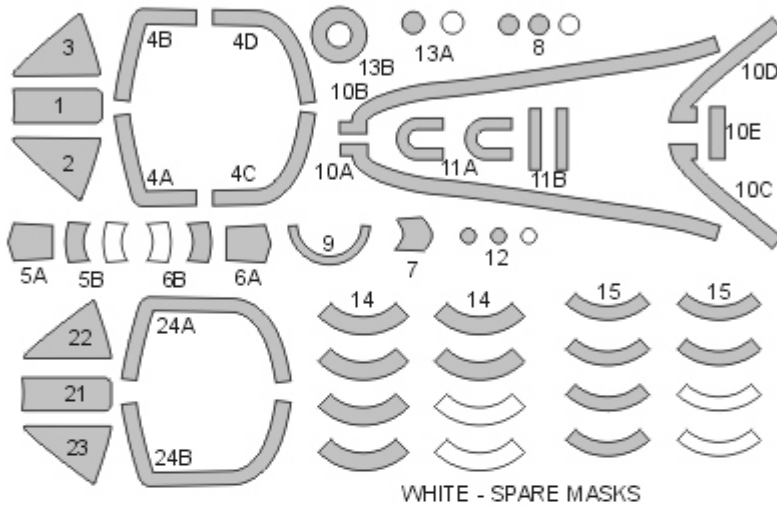

STEP 1 - exterior view
mask interior, paint interior color

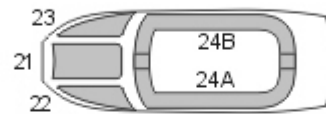

STEP 2
mask exterior, paint camouflage color

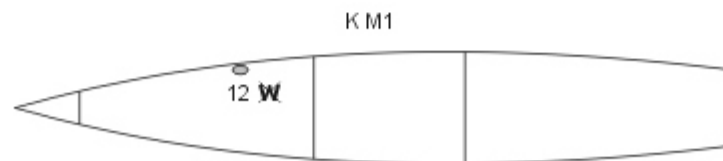
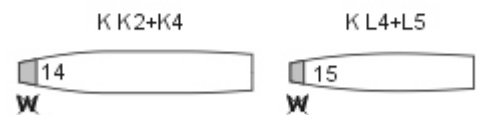
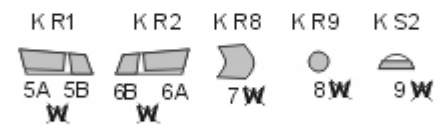
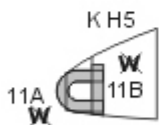
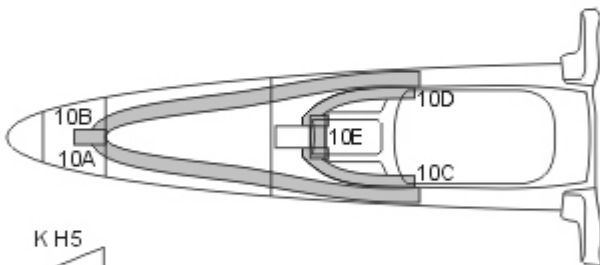
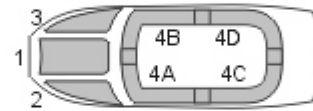

K C2

13A ? 13B

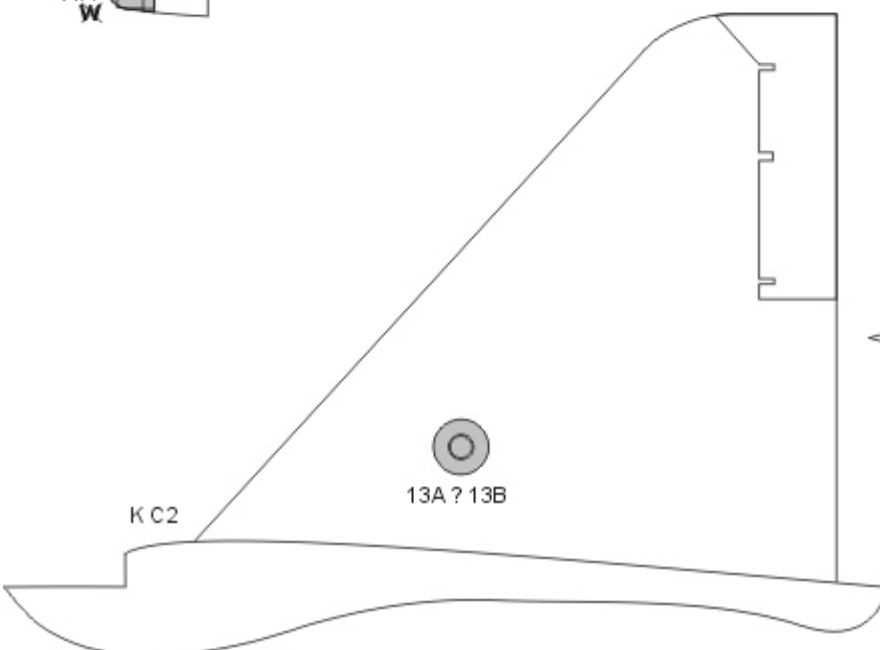



Chinook HC.1 BASIC kabuki masks

for Airfix A06023 kit

<http://mek.kosmo.cz/newware>

tom.nwkits@seznam.cz

Important:

Let the sprayed color dry before applying masks. Remove masks very carefully after painting.

Where the mask is divided into A and B parts, first apply part A, next part B.

The set does not include masks for all areas, so mask the rest with masking tape or liquid mask.

K kit part

^ start placing the mask from this point

Placing wet masks on wet surface is recommended, except those marked by **W**

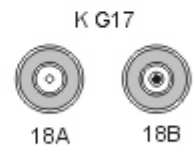
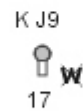
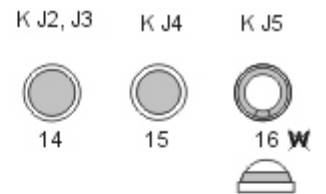
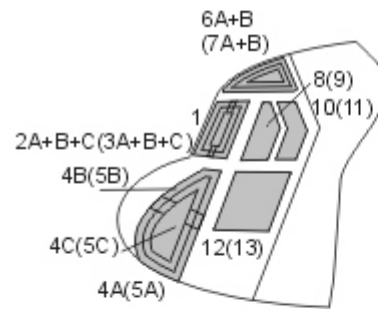
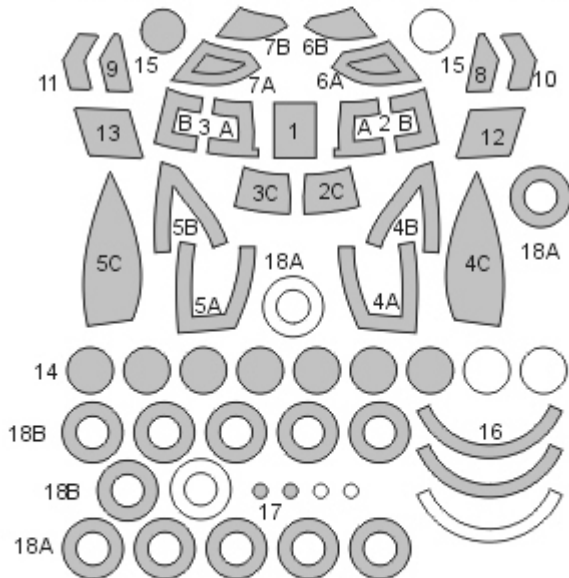

WHITE - SPARE MASKS

NWAM1243

Chinook HC.1 ADVANCED kabuki masks

for Airfix A06023 kit

<http://mek.kosmo.cz/newware>

Includes also windows
seal and camouflage details masks

1/72 scale

tom.nwkits@seznam.cz



Important:

Let the sprayed color dry before applying masks. Remove masks very carefully after painting.

Where the mask is divided into A and B parts, first apply part A, next part B.

The set does not include masks for all areas, so mask the rest with masking tape or liquid mask.

K kit part

* start placing the mask from this point

Placing wet masks on wet surface is recommended, except those marked by **W**

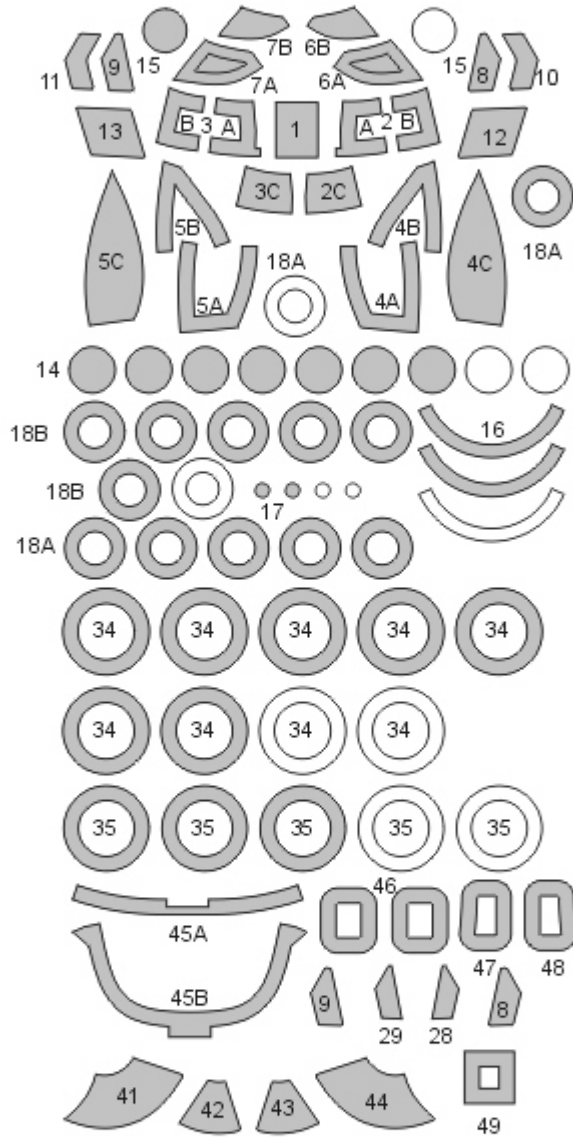

WHITE - SPARE MASKS

K G 41 K G 38 K G 39 K G 42

K J 9

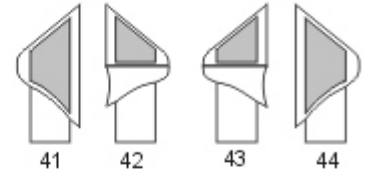

STEP 1
mask exterior, paint interior color

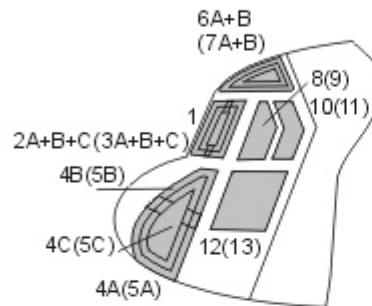

K J 2, J 3

K J 4

K J 5



14

15

16 W

STEP 2
mask exterior, paint seal color (black)

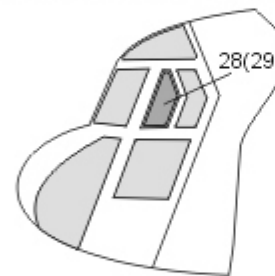

K J 2, J 3

K J 4

K J 5



34

35

35

STEP 3
mask exterior, paint camouflage color

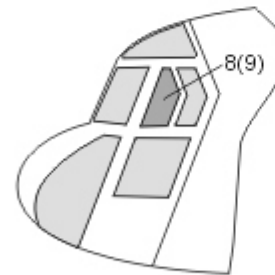

45B

45A

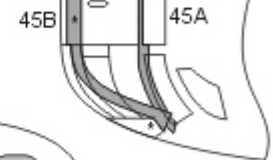

K G 17



18A

18B

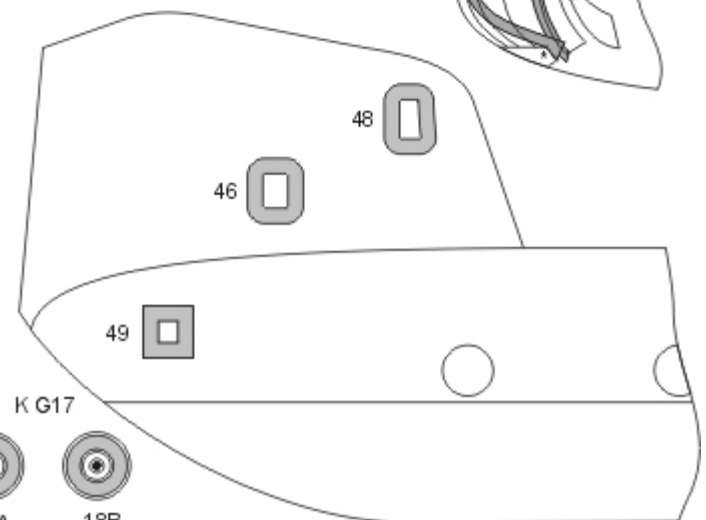
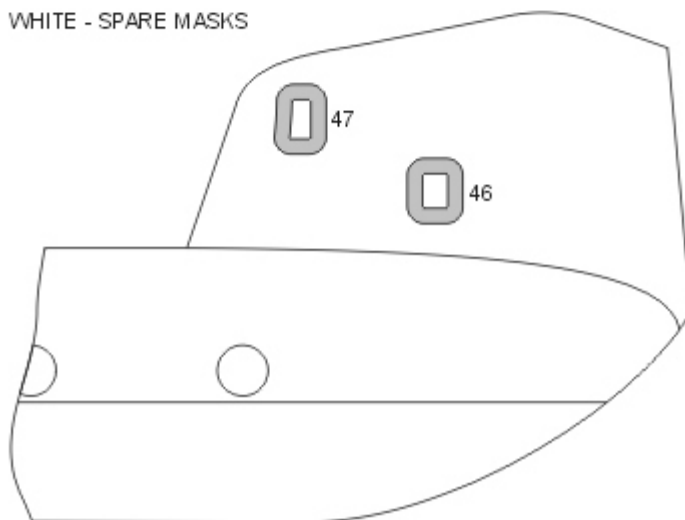



Wyvern S.4 (early version) ADVANCED kabuki masks

for Trumpeter 02843 kit

<http://mek.kosmo.cz/newware>

tom.nwkits@seznam.cz

Important:

Let the sprayed color dry before applying masks. Remove masks very carefully after painting.
 Where the mask is divided into A and B parts, first apply part A, next part B.
 The set does not include masks for all areas, so mask the rest with masking tape or liquid mask.

K kit part

* start placing the mask from this point

Placing wet masks on wet surface is recommended, except those marked by **W**

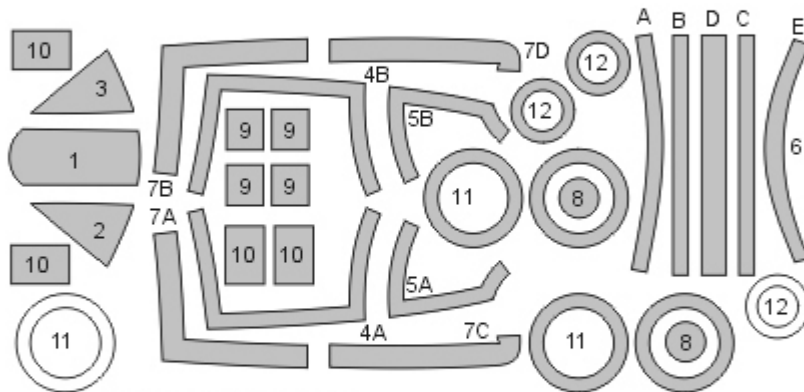

WHITE - SPARE MASKS

K H8, H9



8

K H4, H5 K H6, H7



9 **W**



10 **W**

K E28+E24+ E23+E25



11

K C22



12

STEP 1 - exterior view
 mask interior, paint frame color

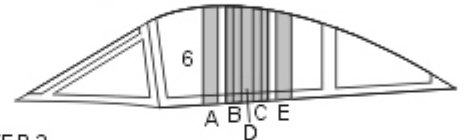

STEP 2
 mask exterior, paint frame color

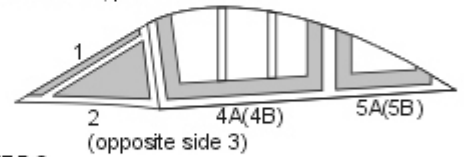

STEP 3
 mask exterior, paint camouflage color

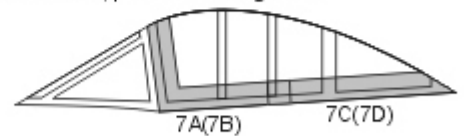



Wyvern S.4 (early version) EXPERT kabuki masks for Trumpeter 02843 kit

<http://mek.kosmo.cz/newware>

Includes also windows
inner side masks

tom.nwkits@seznam.cz

Important:

Let the sprayed color dry before applying masks. Remove masks very carefully after painting.
Where the mask is divided into A and B parts, first apply part A, next part B.
The set does not include masks for all areas, so mask the rest with masking tape or liquid mask.

K kit part

* start placing the mask from this point

Placing wet masks on wet surface is recommended, except those marked by **W**

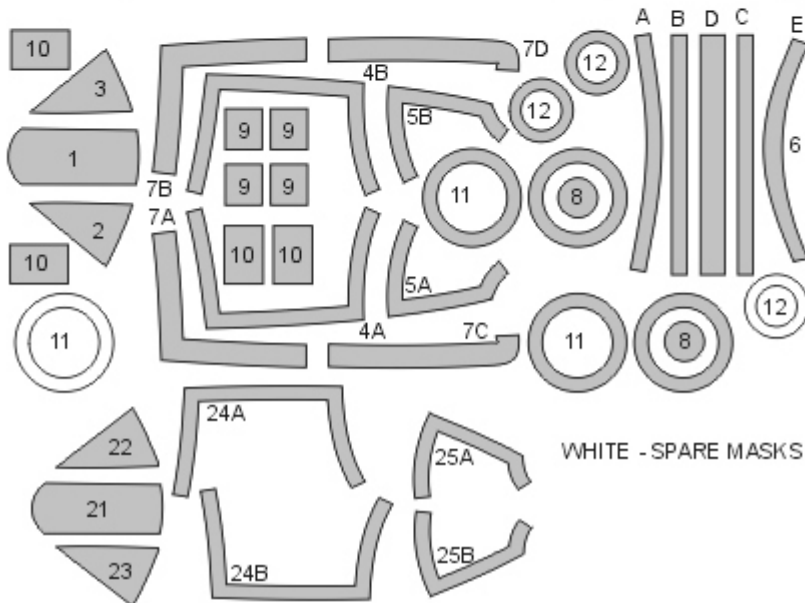

WHITE - SPARE MASKS

K H8, H9



8

K H4, H5 K H6, H7



9 **W**



10 **W**

K E28+E24+ E23+E25



11

K C22



12

STEP 1 - exterior view
mask interior, paint interior color

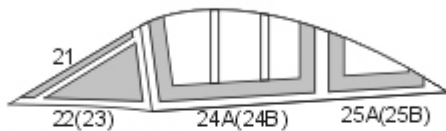

STEP 2 - exterior view
mask interior, paint frame color

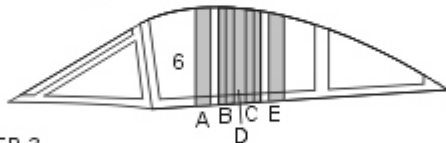

STEP 3
mask exterior, paint frame color

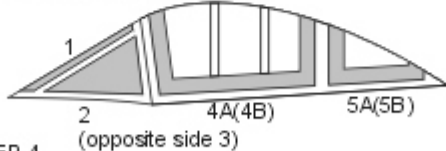

STEP 4
mask exterior, paint camouflage color

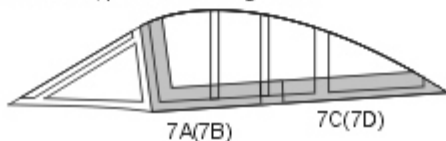

NWAM1246

1/48 scale



A-4 B/C Skyhawk BASIC kabuki masks

for Hobby2000 48031 and 48032 kits

<http://mek.kosmo.cz/newware>

tom.nwkits@seznam.cz

USE ALSO NWAM1248 A-4B/C GREY & WHITE CAMOUFLAGE MASKS

Important:

Let the sprayed color dry before applying masks. Remove masks very carefully after painting.

Where the mask is divided into A and B parts, first apply part A, next part B.

The set does not include masks for all areas, so mask the rest with masking tape or liquid mask.

K kit part

* start placing the mask from this point

Placing wet masks on wet surface is recommended, except those marked by **W**

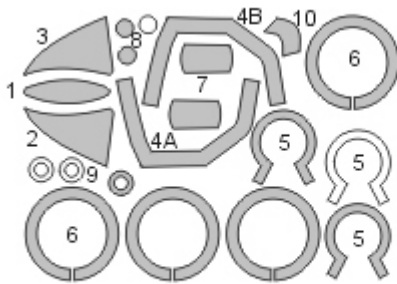

white - spare masks

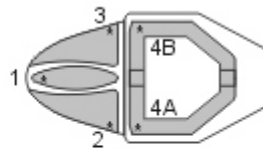

K E 43

K F 18+F 19(F 20)



K M1, M2

K M8

K M6

K M3



NWAM1247

1/48 scale



A-4 B/C Skyhawk EXPERT kabuki masks

for Hobby2000 48031 and 48032 kits

<http://mek.kosmo.cz/newware>

INCLUDES ALSO WINDOW
INNER SIDE AND AIR INTAKE MASKS

tom.nwkits@seznam.cz

USE ALSO NWAM1248 A-4B/C GREY & WHITE CAMOUFLAGE MASKS

Important:

Let the sprayed color dry before applying masks. Remove masks very carefully after painting.

Where the mask is divided into A and B parts, first apply part A, next part B.

The set does not include masks for all areas, so mask the rest with masking tape or liquid mask.

K kit part

* start placing the mask from this point

Placing wet masks on wet surface is recommended, except those marked by **W**

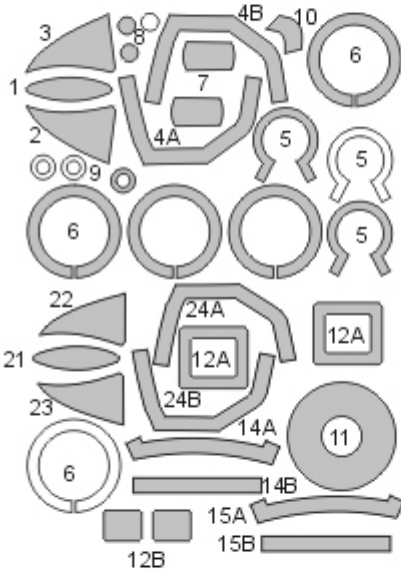

white - spare masks

K E 43

K F18+F19(F20)



STEP 1 - exterior view
mask interior, paint interior color

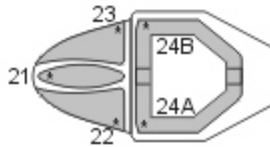

STEP 2
paint camouflage color

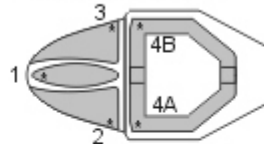

K M1, M2



K M8



K M6



K M3



paint metallic color
K A7
12A

paint frame color
12B

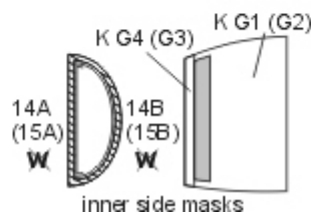

inner side masks

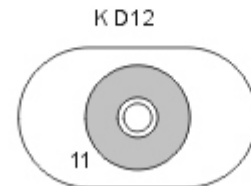

NWAM1248

1/48 scale



A-4 B/C Skyhawk grey & white CAMOUFLAGE kabuki masks

for Hobby2000 48031 and 48032 kits

<http://mek.kosmo.cz/newware>

tom.nwkits@seznam.cz

USE ALSO NWAM1246 OR NWAM1247 A-4 B/C MASKS

Important:

Let the sprayed color dry before applying masks. Remove masks very carefully after painting.

Where the mask is divided into A and B parts, first apply part A, next part B.

The set does not include masks for all areas, so mask the rest with masking tape or liquid mask.

K kit part

* start placing the mask from this point

Placing wet masks on wet surface is recommended, except those marked by **W**

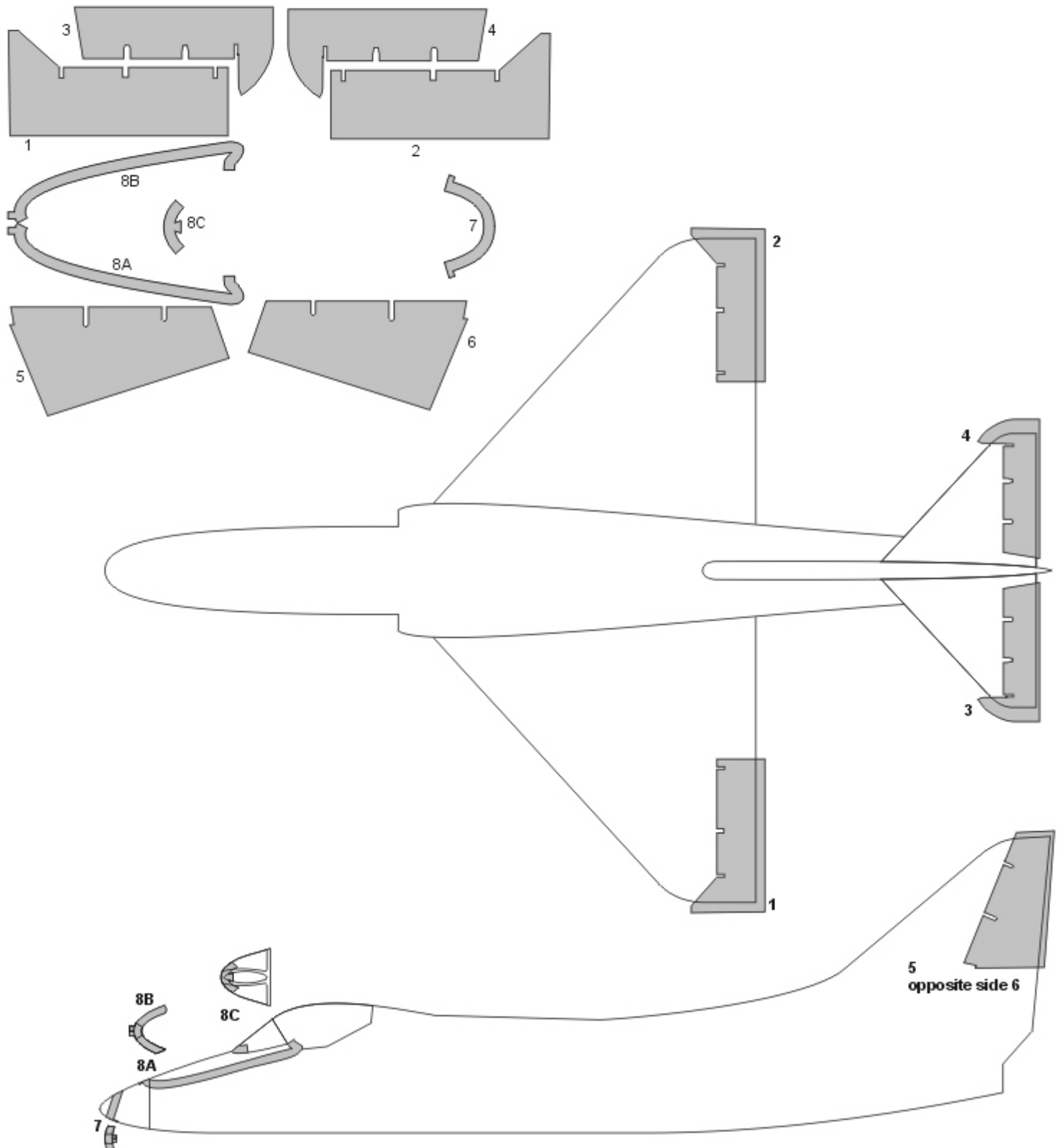



UH-1Y Venom BASIC kabuki masks
for Kitty Hawk KH80124 kit
<http://mek.kosmo.cz/newware>

tom.nwkits@seznam.cz

Important:

Let the sprayed color dry before applying masks. Remove masks very carefully after painting.
Where the mask is divided into A and B parts, first apply part A, next part B.
The set does not include masks for all areas, so mask the rest with masking tape or liquid mask.

K kit part

* start placing the mask from this point

Placing wet masks on wet surface is recommended, except those marked by **W**

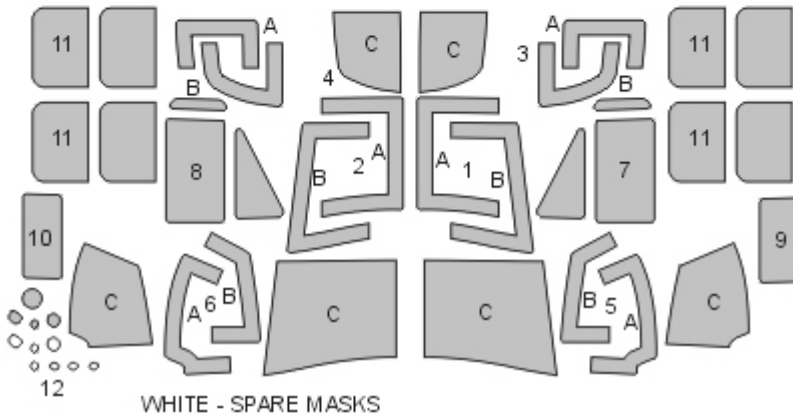

K G12

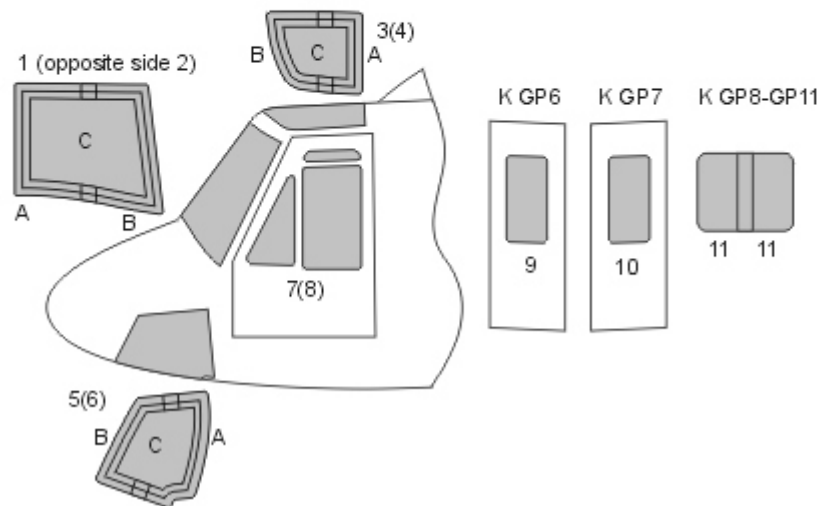



UH-1Y Venom EXPERT kabuki masks
for Kitty Hawk KH80124 kit
<http://mek.kosmo.cz/newware>

Includes also windows
inner side masks

tom.nwkits@seznam.cz

Important:

Let the sprayed color dry before applying masks. Remove masks very carefully after painting.
Where the mask is divided into A and B parts, first apply part A, next part B.
The set does not include masks for all areas, so mask the rest with masking tape or liquid mask.

K kit part

* start placing the mask from this point

Placing wet masks on wet surface is recommended, except those marked by **W**

K G12

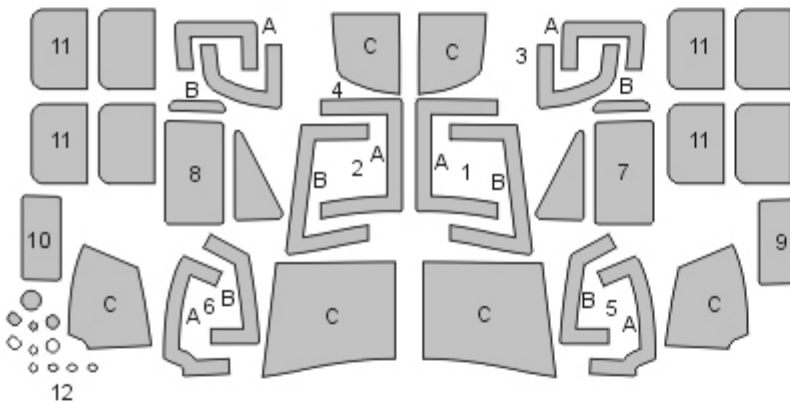

STEP 1 - exterior view
mask interior, paint interior color

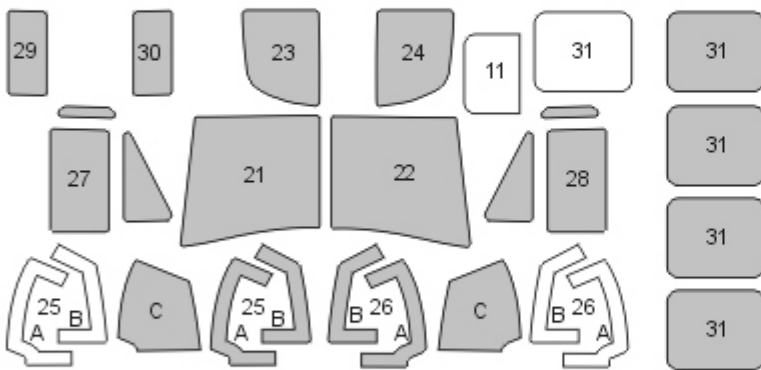
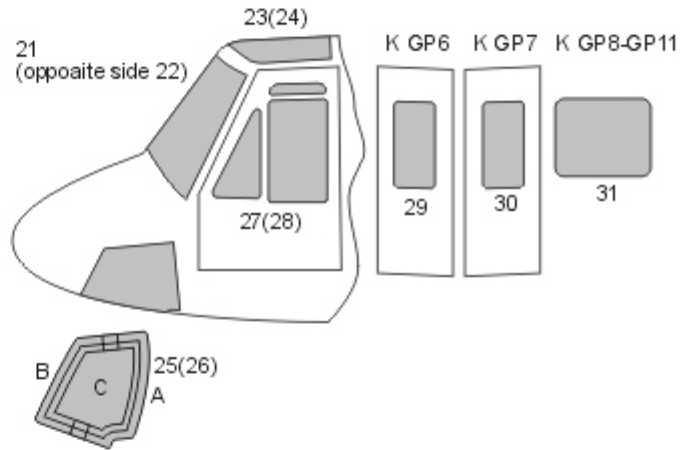

STEP 2
mask exterior, paint camouflage color

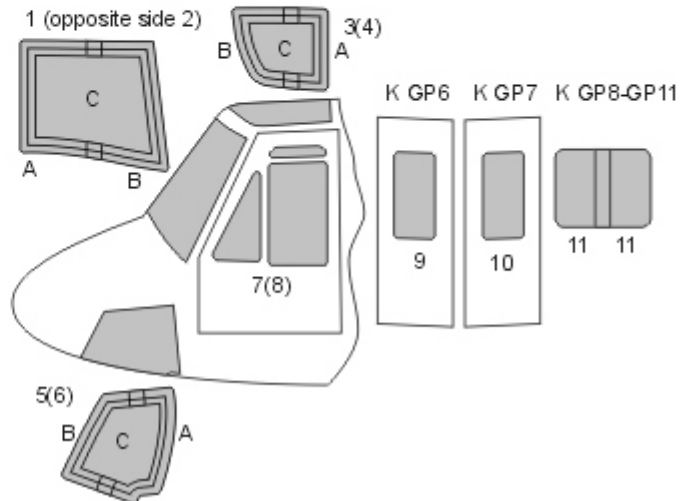

WHITE - SPARE MASKS