



NEW WARE NEWSLETTER

NEW MASKS MAY 2024

| | |
|--|------------------|
| NWAM1217 1/48 B-26B Marauder BASIC kabuki masks | ICM |
| NWAM1218 1/48 B-26B Marauder EXPERT kabuki masks | ICM |
| NWAM1219 1/72 C-47 Skytrain, Dakota M k.III(Mk.IV) BASIC kabuki masks | Airfix, Heller |
| NWAM1220 1/72 C-47 Skytrain, Dakota M k.III(Mk.IV) EXPERT kabuki masks | Airfix, Heller |
| NWAM1221 1/48 AH-1Z Viper BASIC kabuki masks | Zimi, Kitty Hawk |
| NWAM1222 1/48 AH-1Z Viper EXPERT kabuki masks | Zimi, Kitty Hawk |



B-26B Marauder BASIC kabuki masks

for ICM 48320 kit

<http://mek.kosmo.cz/newware>

tom.nwkits@seznam.cz

Important:

Let the sprayed color dry before applying masks. Remove masks very carefully after painting.
Where the mask is divided into A and B parts, first apply part A, next part B.
The set does not include masks for all areas, so mask the rest with masking tape or liquid mask.

K kit part

* start placing the mask from this point

Placing wet masks on wet surface is recommended, except those marked by **W**

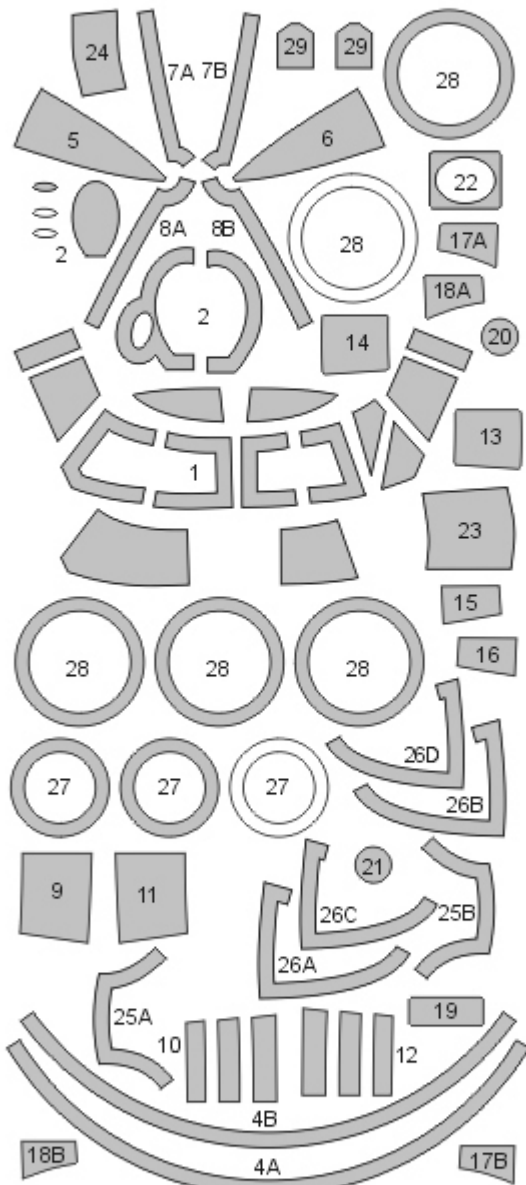
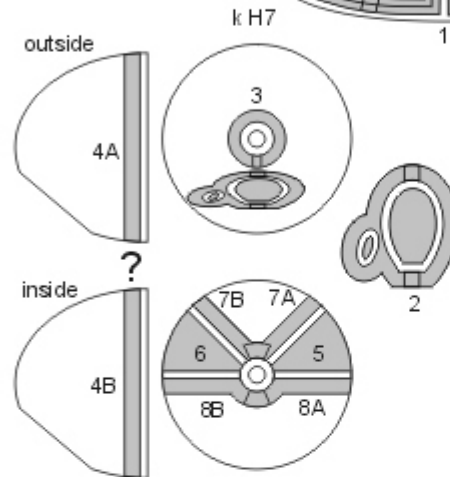
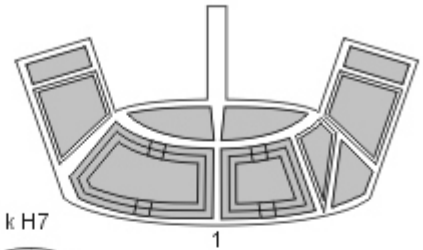

white - spare parts

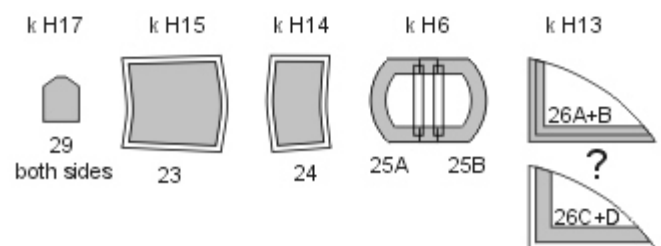
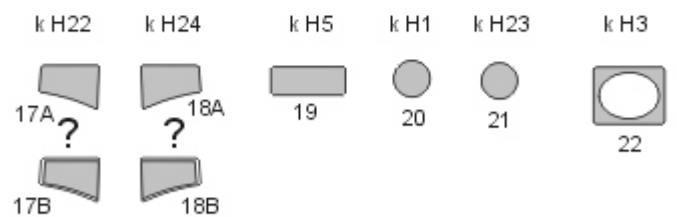
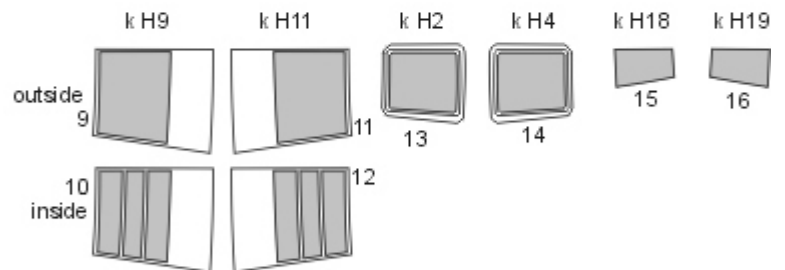

k F54+D20+F56



k D34+D21+D33

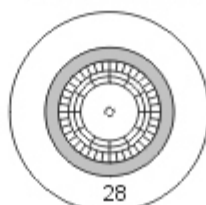



NWAM1218

B-26B Marauder EXPERT kabuki masks

for ICM 48320 kit

<http://mek.kosmo.cz/newware>

*Includes also windows
inner side masks, camouflage detail
and bombs yellow stripes masks*

1/48 scale

tom.nwkits@seznam.cz

Important:

Let the sprayed color dry before applying masks. Remove masks very carefully after painting.
Where the mask is divided into A and B parts, first apply part A, next part B.
The set does not include masks for all areas, so mask the rest with masking tape or liquid mask.

K kit part

^ start placing the mask from this point

Placing wet masks on wet surface is recommended, except those marked by **W**

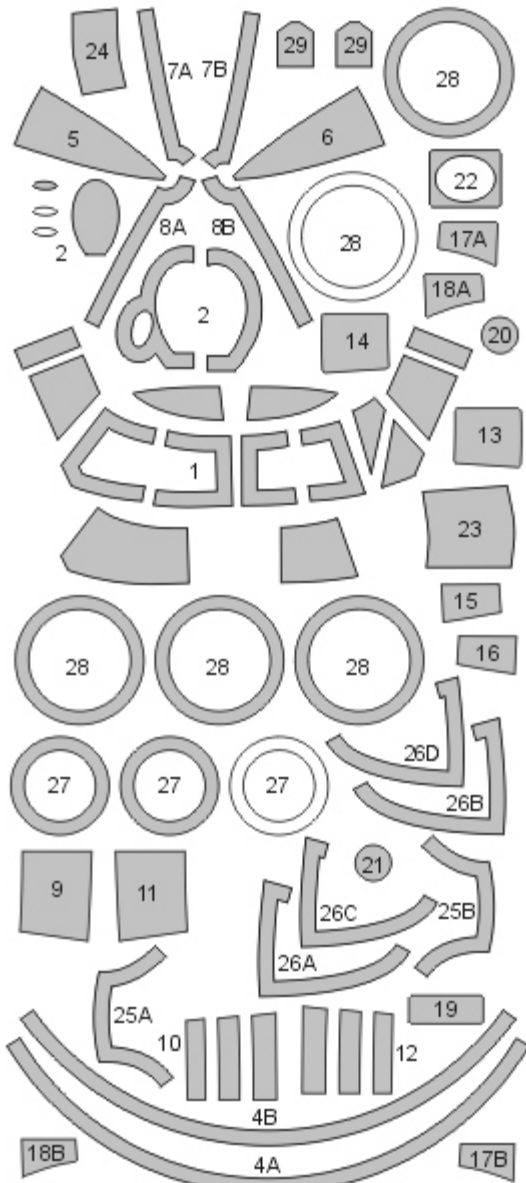

white - spare parts

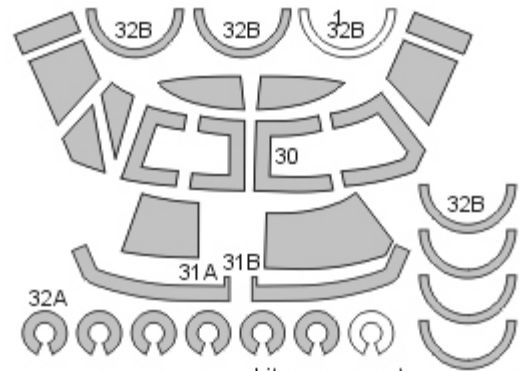

white - spare parts

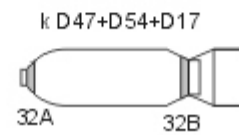
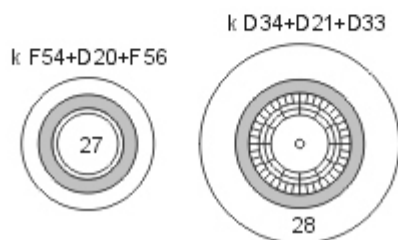
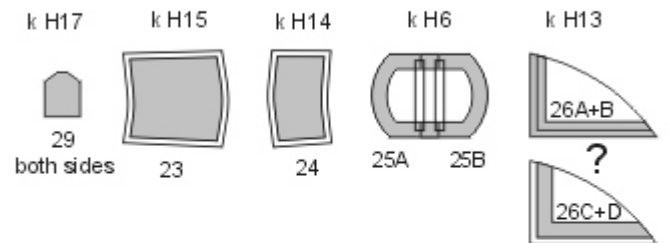
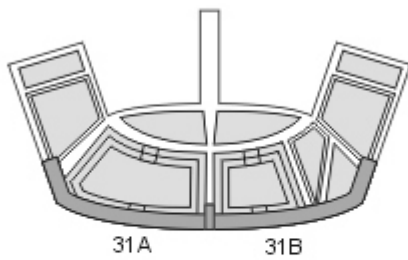
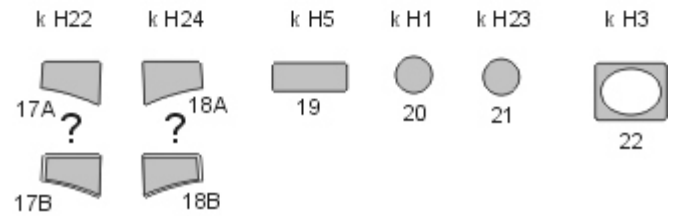
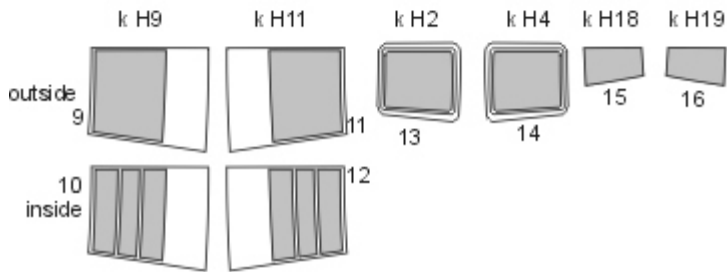
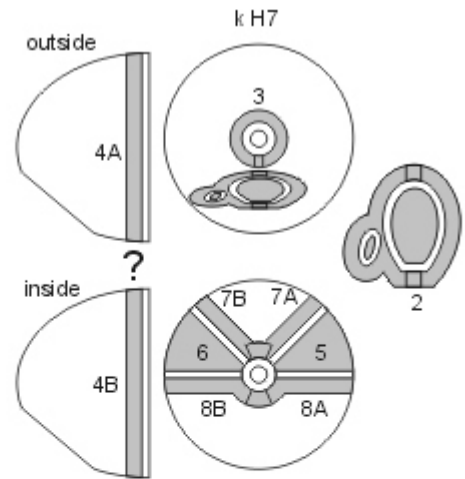
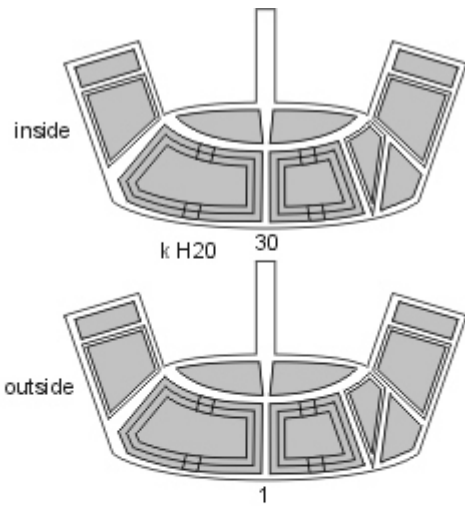



C-47 Skytrain, Dakota Mk.III(Mk.IV) BASIC kabuki masks

for Airfix A08014, A08015(A), A09008

and Heller C-47 Dakota kits

<http://mek.kosmo.cz/newware>

tom.nwkits@seznam.cz

Important:

Let the sprayed color dry before applying masks. Remove masks very carefully after painting.
Where the mask is divided into A and B parts, first apply part A, next part B.
The set does not include masks for all areas, so mask the rest with masking tape or liquid mask.

K kit part

^ start placing the mask from this point

Placing wet masks on wet surface is recommended, except those marked by **W**

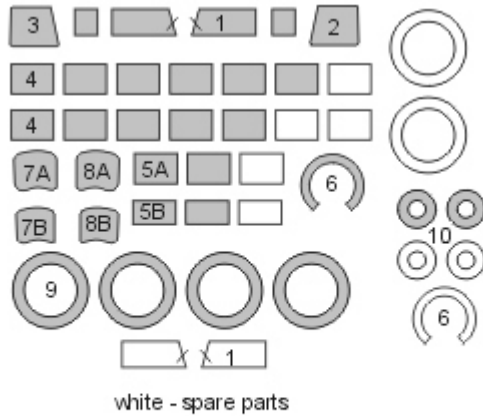

white - spare parts

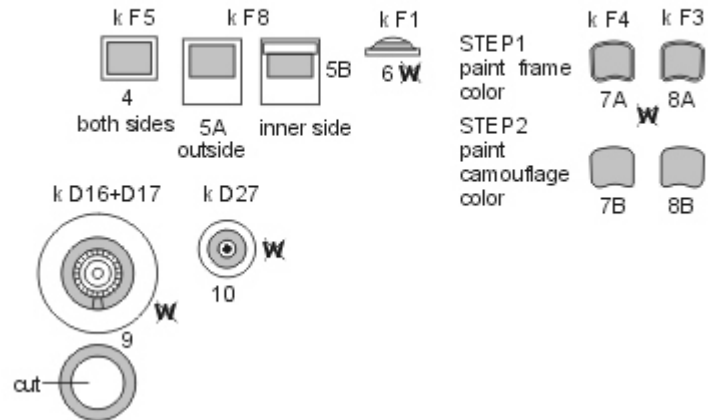
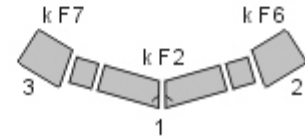

STEP1
paint frame
color

STEP2
paint
camouflage
color



NWAM1220

C-47 Skytrain, Dakota Mk.III(Mk.IV) BASIC kabuki masks

for Airfix A08014, A08015(A), A09008

and Heller C-47 Dakota kits

<http://mek.kosmo.cz/newware>

Includes also windows
inner side masks and camouflage
detail masks

1/72 scale

tom.nwkits@seznam.cz

Important:

Let the sprayed color dry before applying masks. Remove masks very carefully after painting.

Where the mask is divided into A and B parts, first apply part A, next part B.

The set does not include masks for all areas, so mask the rest with masking tape or liquid mask.

K kit part

^ start placing the mask from this point

Placing wet masks on wet surface is recommended, except those marked by **W**

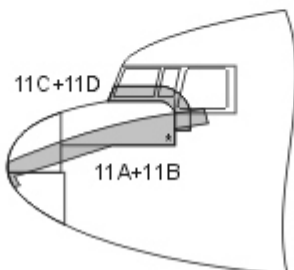
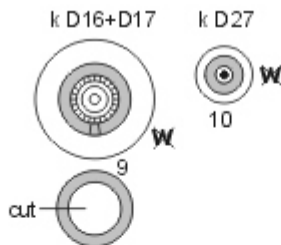
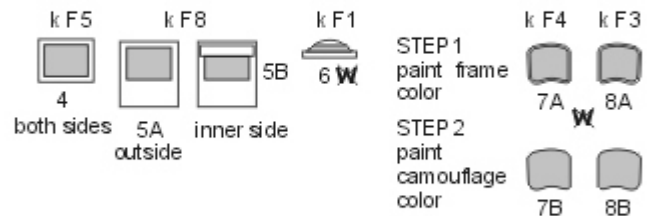
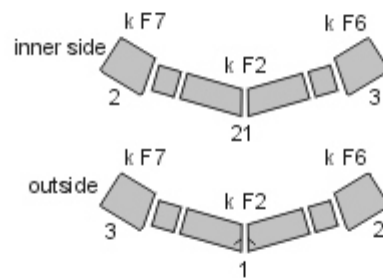
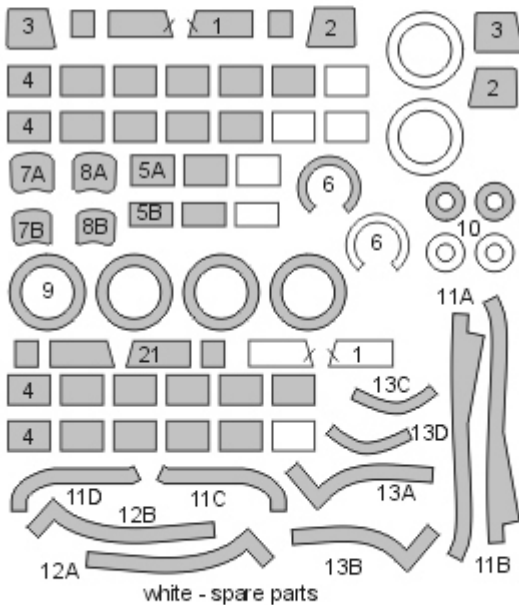

K A2+B7 (A1+C8)



12A+12B
(12B+12A)

K B4+B5+B1 (B3+B6+B2)

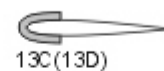

13C(13D)



13A+13B
(13B+13A)



AH-1Z Viper BASIC kabuki masks
 for Zimi ZM80125 and Kitty Hawk KH80125 kits
<http://mek.kosmo.cz/newware>

tom.nwkits@seznam.cz

Important:

Let the sprayed color dry before applying masks. Remove masks very carefully after painting.
 Where the mask is divided into A and B parts, first apply part A, next part B.
 The set does not include masks for all areas, so mask the rest with masking tape or liquid mask.

K kit part

^ start placing the mask from this point

Placing wet masks on wet surface is recommended, except those marked by **W**

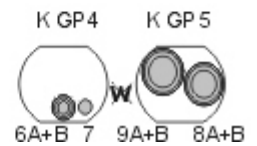
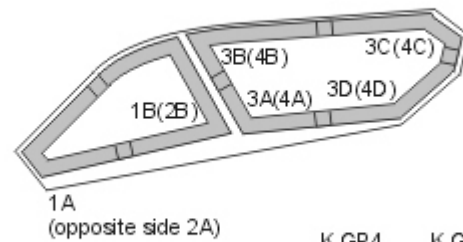
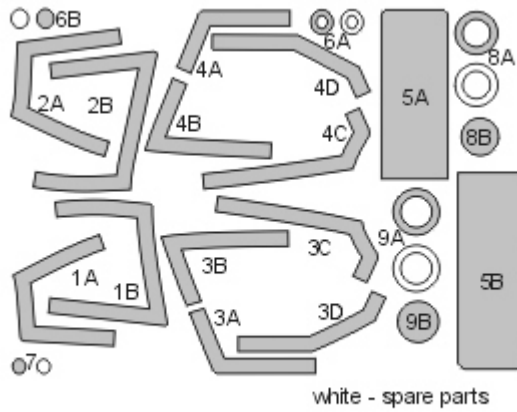



AH-1Z Viper EXPERT kabuki masks
 for Zimi ZM80125 and Kitty Hawk KH80125 kits
<http://mek.kosmo.cz/newware>

Includes also windows
 inner side masks

tom.nwkits@seznam.cz

Important:

Let the sprayed color dry before applying masks. Remove masks very carefully after painting.
 Where the mask is divided into A and B parts, first apply part A, next part B.
 The set does not include masks for all areas, so mask the rest with masking tape or liquid mask.

K kit part

^ start placing the mask from this point

Placing wet masks on wet surface is recommended, except those marked by **W**

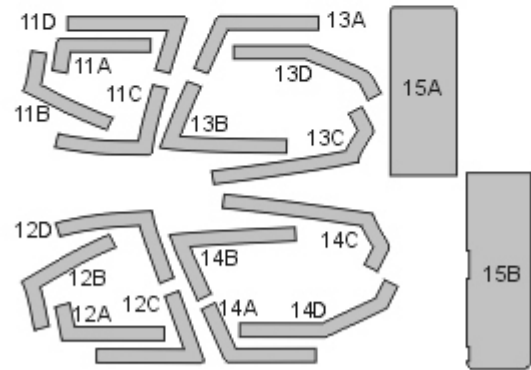
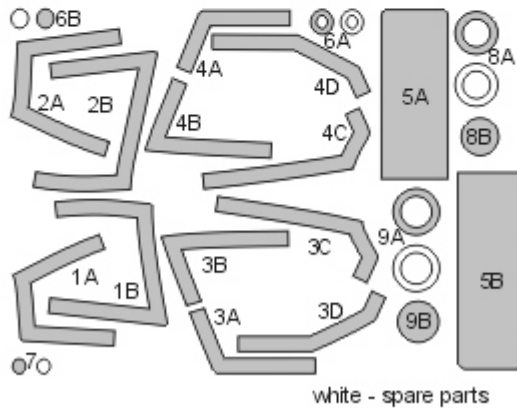

STEP 1 (exterior view)

mask interior, paint interior color

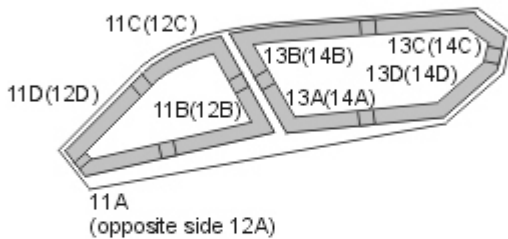
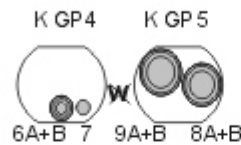

STEP 2

mask exterior, paint camouflage color

