



NEW WARE NEWSLETTER

NEW MASKS APRIL 2024

NWAM 1203 1/48 C-47A, C-48C, DC-3 BASIC kabuki masks	HobbyBoss
NWAM 1204 1/48 C-47A, C-48C, DC-3 EXPERT kabuki masks	HobbyBoss
NWAM 1205 1/48 C-47A, C-48C, DC-3 CAMOUFLAGEDDETAILSkabuki masks	HobbyBoss
NWAM 1206 1/48 AH-1Q/ SCobra BASIC kabuki masks	Special Hobby
NWAM 1207 1/48 AH-1Q/ SCobra EXPERT kabuki masks	Special Hobby
NWAM 1208 1/48 Blackburn Buccaneer S.2B ADVANCED kabuki masks	Airfix
NWAM 1209 1/48 Blackburn Buccaneer S.2B EXPERT kabuki masks	Airfix
NWAM 1210 1/72 Boeing 737-800, C-40A, P-8A Poseidon, E-7A Wedgetail BIG kabuki masks	BPK
NWAM 1211 1/72 Boeing 737-800, C-40A, P-8A Poseidon, E-7A Wedgetail SMALL kabuki masks	BPK
NWAM 1212 1/48 Bell AB-212/ UH-1N BASIC kabuki masks	Italeri, Heller
NWAM 1213 1/48 Bell AB-212/ UH-1N EXPERT kabuki masks	Italeri, Heller
NWAM 1214 1/72 Tu-2(S) kabuki masks	ICM, SBK
NWAM 1215 1/48 MiG-29UB ADVANCED kabuki masks	Academy, Hobby2000, Kora
NWAM 1216 1/48 MiG-29UB EXPERT kabuki masks	Academy, Hobby2000, Kora

NWAM1203

1/48 scale



C-47A, C-48C, DC-3 BASIC kabuki masks

for HobbyBoss 05813, 02828, 02829 and other kits

<http://mek.kosmo.cz/newware>

tom.nwkits@seznam.cz

Use also NWAM1205 CAMOUFLAGE DETAILS MASKS

Important:

Let the sprayed color dry before applying masks. Remove masks very carefully after painting.

Where the mask is divided into A and B parts, first apply part A, next part B.

The set does not include masks for all areas, so mask the rest with masking tape or liquid mask.

Kit part

* start placing the mask from this point

Placing wet masks on wet surface is recommended, except those marked by **W**

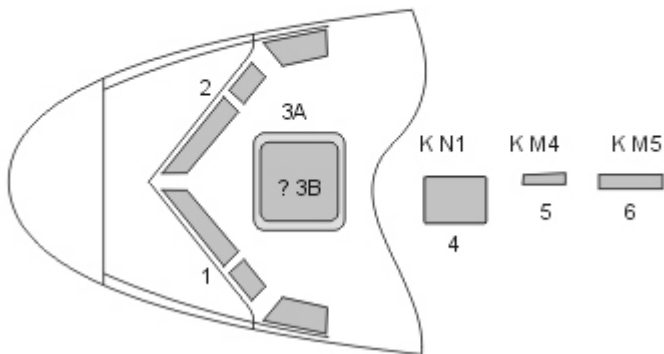
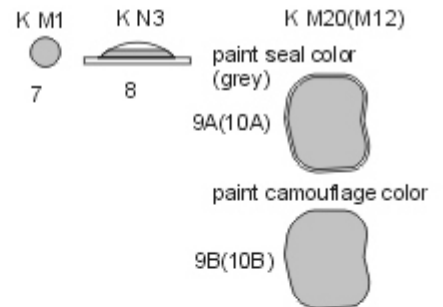
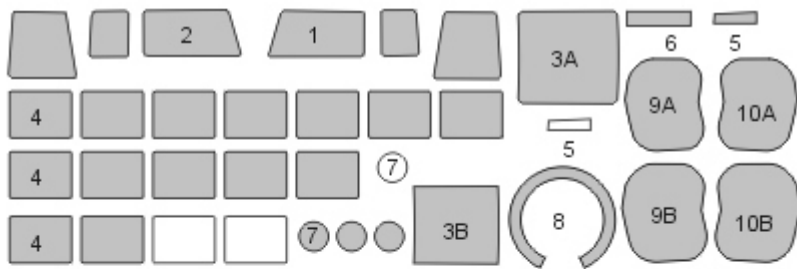

NWAM1204

1/48 scale



C-47A, C-48C, DC-3 EXPERT kabuki masks
for HobbyBoss 05813, 02828, 02829 and other kits
<http://mek.kosmo.cz/newware>

INCLUDES ALSO WINDOWS
INNER SIDE MASKS

tom.nwkits@seznam.cz

Use also NWAM1205 CAMOUFLAGE DETAILS MASKS

Important:

Let the sprayed color dry before applying masks. Remove masks very carefully after painting.
Where the mask is divided into A and B parts, first apply part A, next part B.
The set does not include masks for all areas, so mask the rest with masking tape or liquid mask.

K kit part

* start placing the mask from this point

Placing wet masks on wet surface is recommended, except those marked by **W**

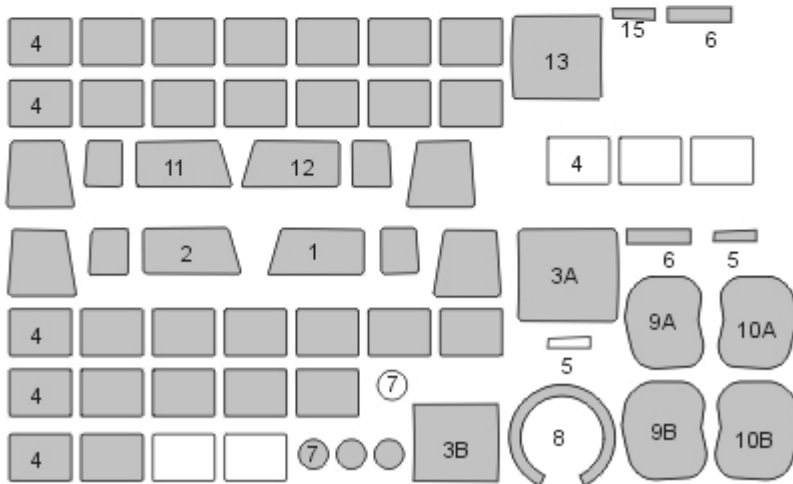

white - spare parts

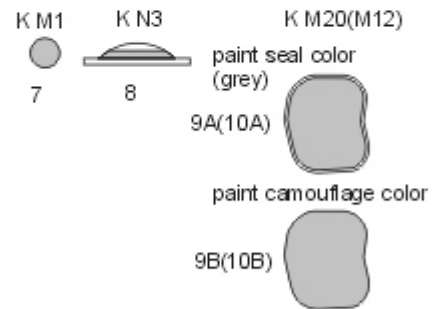

STEP 1 - exterior view

mask interior, paint interior color

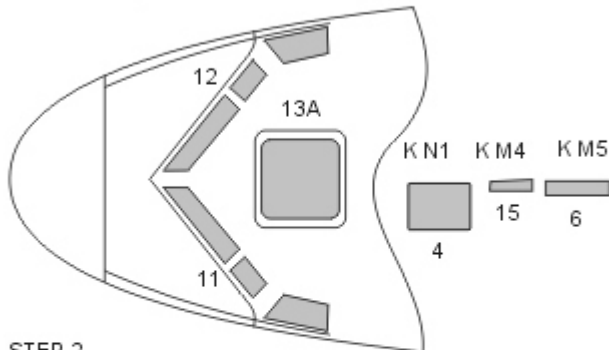

STEP 2

mask exterior, paint camouflage color

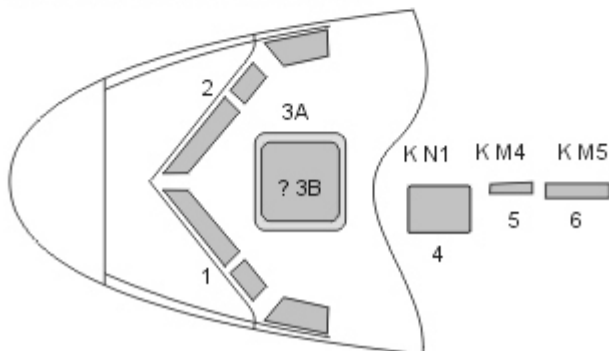



C-47A, C-48C, DC-3 CAMOUFLAGE DETAILS kabuki masks

for HobbyBoss 05813, 02828, 02829 and other kits

<http://mek.kosmo.cz/newware>

tom.nwkits@seznam.cz

Use also NWAM1203 BASIC or NWAM1204 EXPERT kabuki masks

Important:

Let the sprayed color dry before applying masks. Remove masks very carefully after painting.
Where the mask is divided into A and B parts, first apply part A, next part B.
The set does not include masks for all areas, so mask the rest with masking tape or liquid mask.

Kit part

* start placing the mask from this point

Placing wet masks on wet surface is recommended, except those marked by **W**

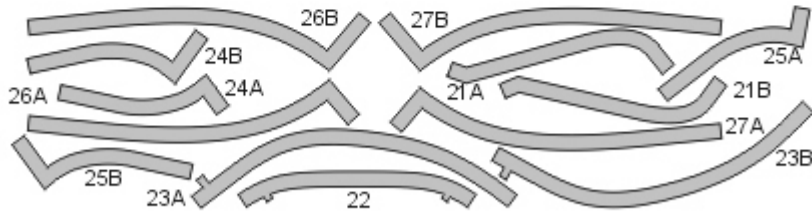

white - spare parts

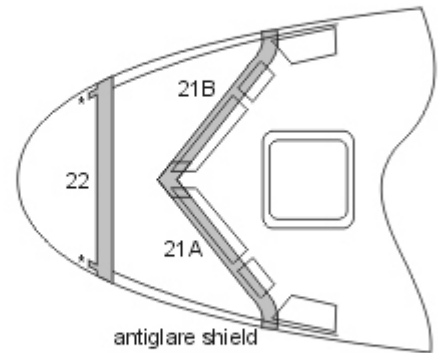

antiglare shield

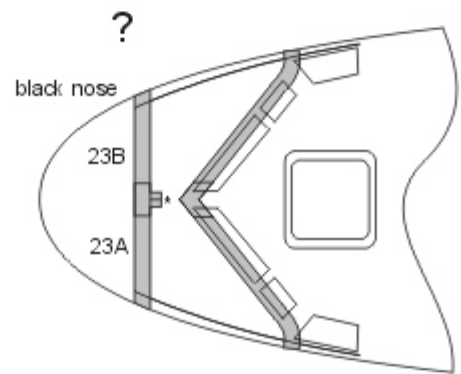

black nose

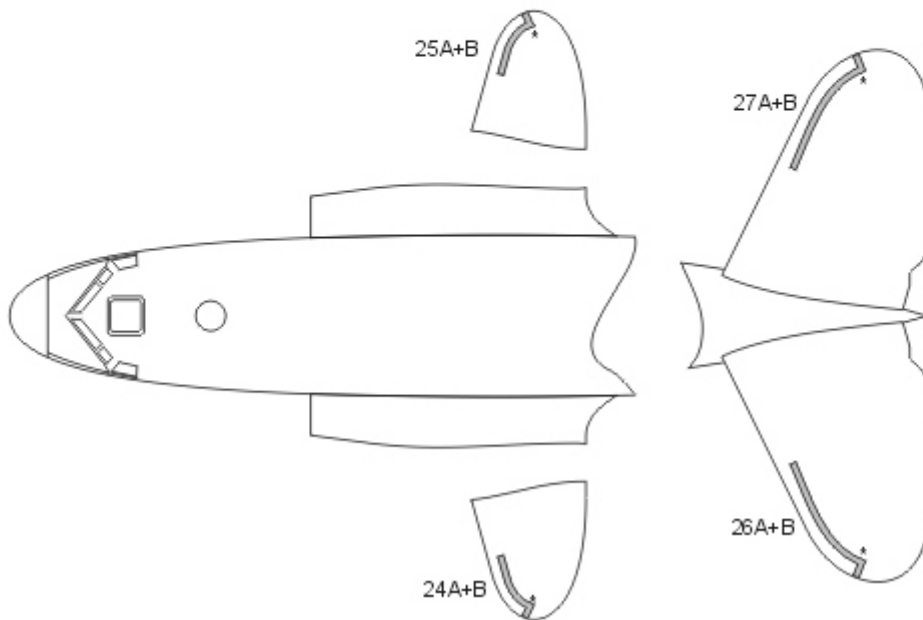

NWAM1206

1/48 scale



AH-1Q/S Cobra BASIC kabuki masks
for Special Hobby SH48232, SH48224 and other kits
<http://mek.kosmo.cz/newware>

tom.nwkits@seznam.cz

Important:

Let the sprayed color dry before applying masks. Remove masks very carefully after painting.
Where the mask is divided into A and B parts, first apply part A, next part B.
The set does not include masks for all areas, so mask the rest with masking tape or liquid mask.

Kit part

* start placing the mask from this point

Placing wet masks on wet surface is recommended, except those marked by **W**

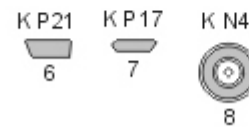
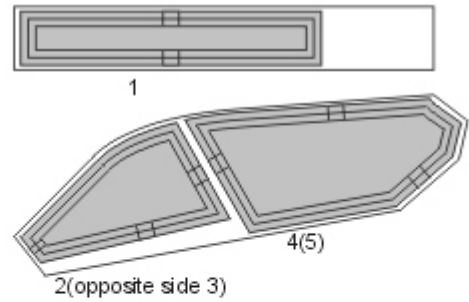
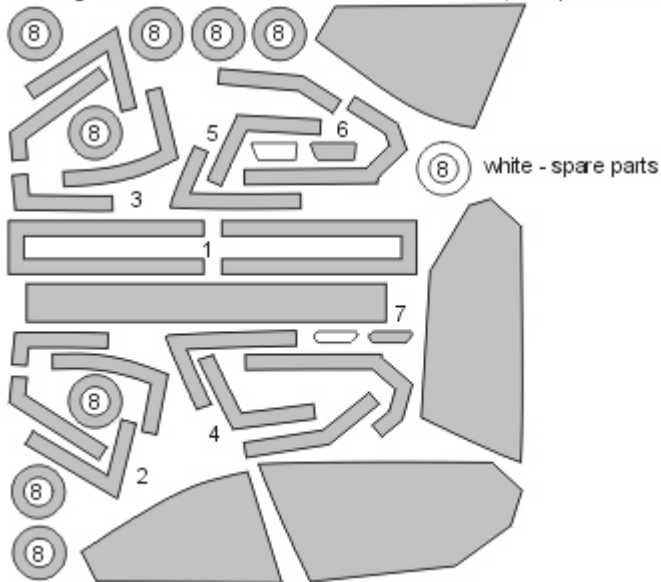

NWAM1207

1/48 scale



AH-1Q/S Cobra EXPERT kabuki masks
for Special Hobby SH48232, SH48224 and other kits
<http://mek.kosmo.cz/newware>

INCLUDES ALSO WINDOWS
"SEAL" INNER SIDE MASKS

tom.nwkits@seznam.cz

Important:

Let the sprayed color dry before applying masks. Remove masks very carefully after painting.
Where the mask is divided into A and B parts, first apply part A, next part B.
The set does not include masks for all areas, so mask the rest with masking tape or liquid mask.

Kit part

* start placing the mask from this point

Placing wet masks on wet surface is recommended, except those marked by **W**

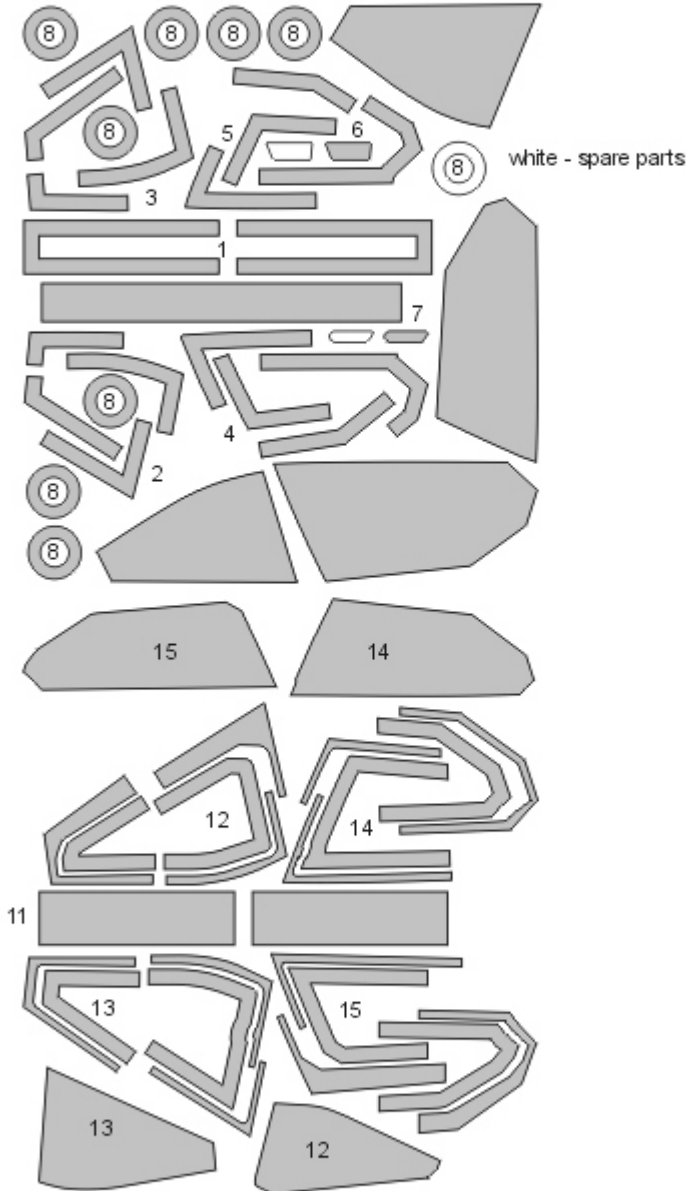

STEP 1 - exterior view

mask interior

paint interior color

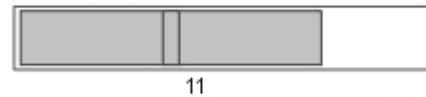

paint black

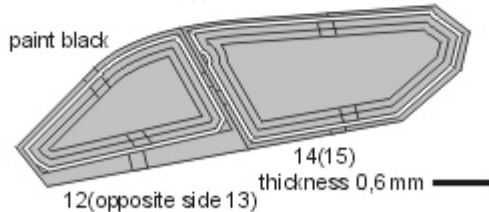

STEP 2

mask exterior, paint camouflage color

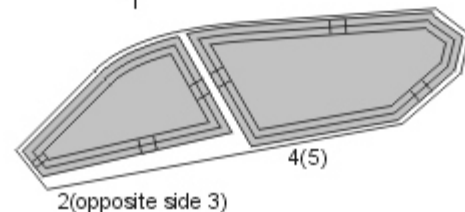
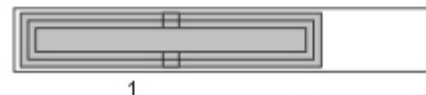



Blackburn Buccaneer S.2B ADVANCED kabuki masks

for Airfix A12014 kit

<http://mek.kosmo.cz/newware>

tom.nwkits@seznam.cz

Important:

Let the sprayed color dry before applying masks. Remove masks very carefully after painting.
Where the mask is divided into A and B parts, first apply part A, next part B.
The set does not include masks for all areas, so mask the rest with masking tape or liquid mask.

K kit part

* start placing the mask from this point

Placing wet masks on wet surface is recommended, except those marked by **W**

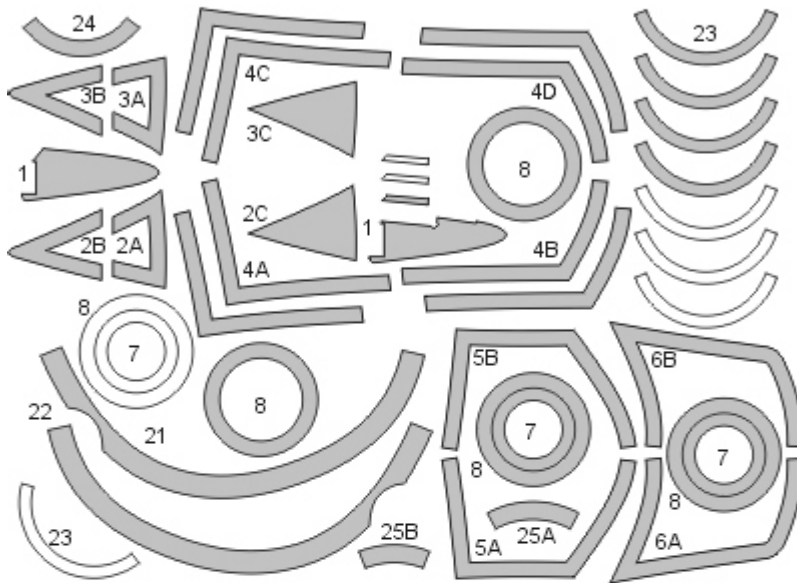

K G21+G22 K G40(G41)+G43(G42)



K A17

K A16

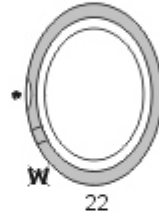

white - spare parts

STEP 1
paint interior color

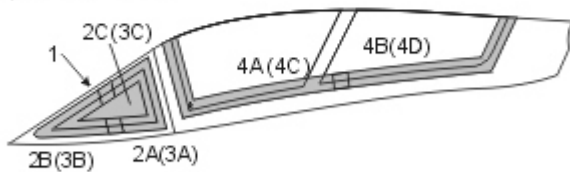

STEP 2
paint frame color (Humbrol 93)

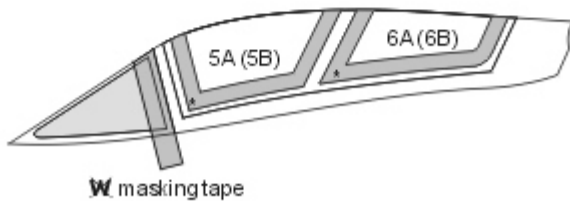

STEP 3
paint camouflage color

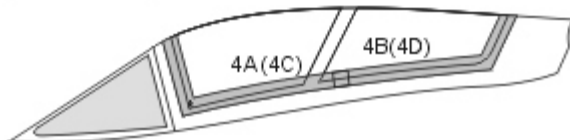

K H61+H62

K H44



replacement of decal no. 136



Blackburn Buccaneer S.2B EXPERT kabuki masks

for Airfix A12014 kit

<http://mek.kosmo.cz/newware>

INCLUDES ALSO
WINDOWS INNER SIDE MASKS

tom.nwkits@seznam.cz

Important:

Let the sprayed color dry before applying masks. Remove masks very carefully after painting.

Where the mask is divided into A and B parts, first apply part A, next part B.

The set does not include masks for all areas, so mask the rest with masking tape or liquid mask.

K kit part

* start placing the mask from this point

Placing wet masks on wet surface is recommended, except those marked by **W**

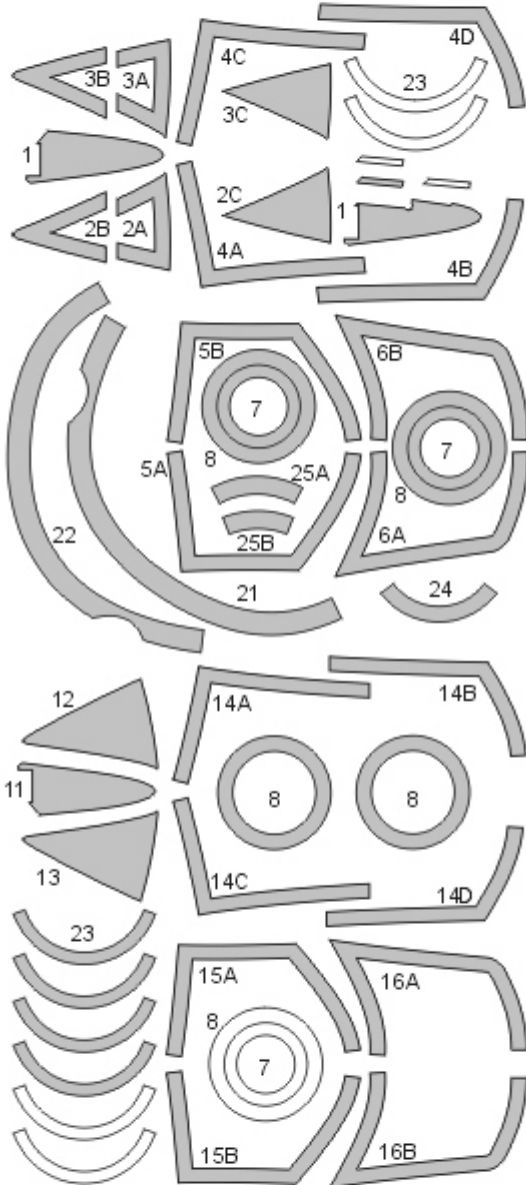

white - spare parts

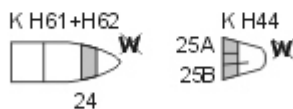

replacement of decal no. 136

K G21+G22 K G40(G41)+G43(G42)

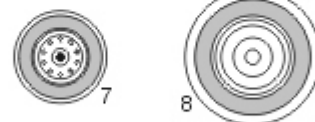

K A17 K A16

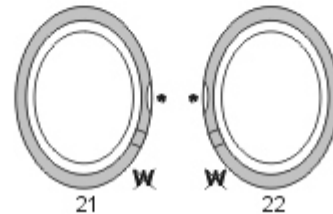

STEP 1 (exterior view)

mask interior, paint frame color (Humbrol 93)

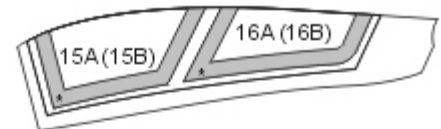

STEP 2 (exterior view)

mask interior, paint interior color

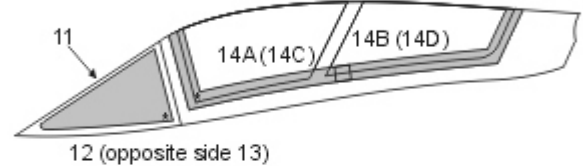

STEP 3

mask exterior, paint frame color (Humbrol 93)

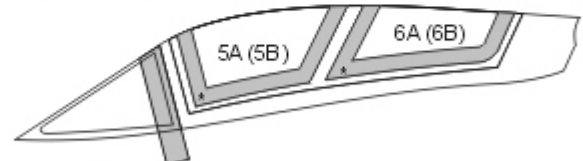

W masking tape

STEP 4

mask exterior, paint camouflage color

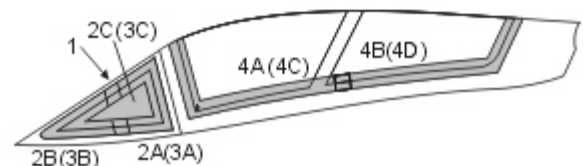

NWAM1210



Boeing 737-800, C-40A, P-8A Poseidon, E-7A Wedgetail **BIG** kabuki masks
 for BPK 7518, 7219, 7222, 7224, 7225 and other kits
<http://mek.kosmo.cz/newware>

1/72 scale
 Use together with masks included in your kit

tom.nwkits@seznam.cz

Important:

Let the sprayed color dry before applying masks. Remove masks very carefully after painting.
 Where the mask is divided into A and B parts, first apply part A, next part B.
 The set does not include masks for all areas, so mask the rest with masking tape or liquid mask.

K kit part

* start placing the mask from this point

Placing wet masks on wet surface is recommended, except those marked by **W**

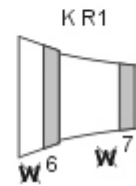
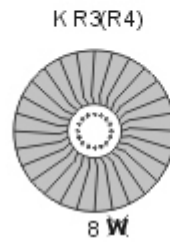
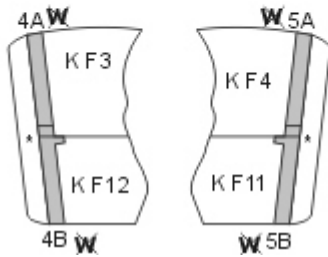
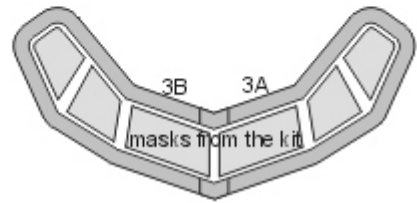
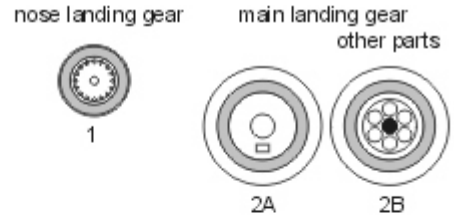
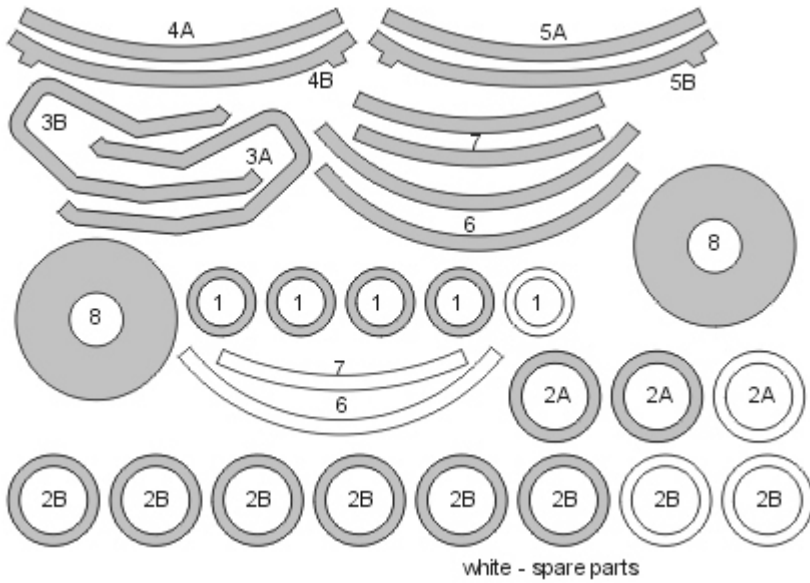

NWAM1211

1/72 scale



Boeing 737-800, C-40A, P-8A Poseidon, E-7A Wedgetail SMALL kabuki masks

for BPK 7518, 7219, 7222, 7224, 7225 and other kits

<http://mek.kosmo.cz/newware>

Use together with masks included in your kit

tom.nwkits@seznam.cz

Important:

Let the sprayed color dry before applying masks. Remove masks very carefully after painting.

Where the mask is divided into A and B parts, first apply part A, next part B.

The set does not include masks for all areas, so mask the rest with masking tape or liquid mask.

K kit part

* start placing the mask from this point

Placing wet masks on wet surface is recommended, except those marked by **W**

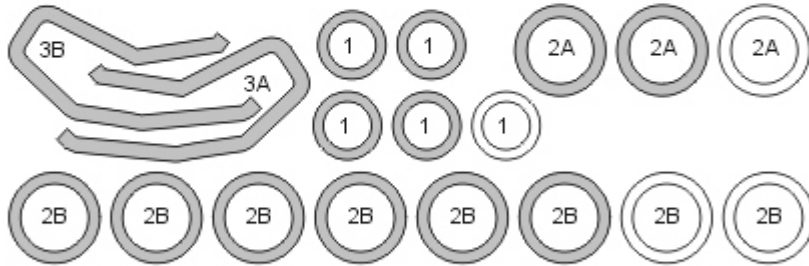

white - spare parts

nose landing gear



1

main landing gear



2A

other parts

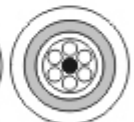

2B

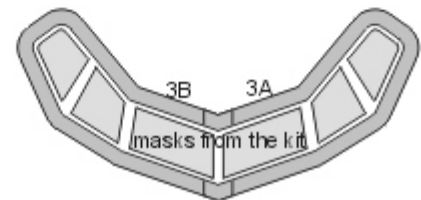



Bell AB 212 / UH-1N BASIC kabuki masks
 for Italeri 2692, 847 and Heller 80413 kits
<http://mek.kosmo.cz/newware>

tom.nwkits@seznam.cz

Important:

Let the sprayed color dry before applying masks. Remove masks very carefully after painting.
 Where the mask is divided into A and B parts, first apply part A, next part B.
 The set does not include masks for all areas, so mask the rest with masking tape or liquid mask.

K kit part

^ start placing the mask from this point

Placing wet masks on wet surface is recommended, except those marked by **W**

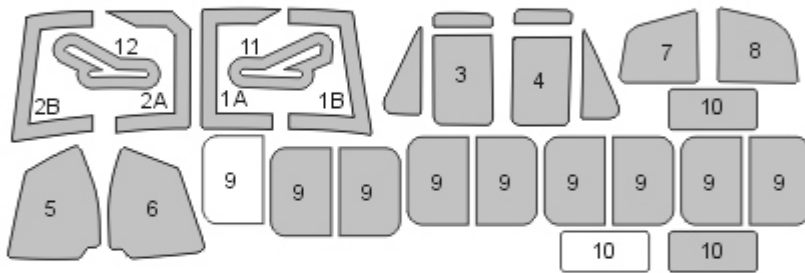

white - spare parts

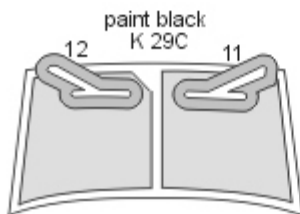
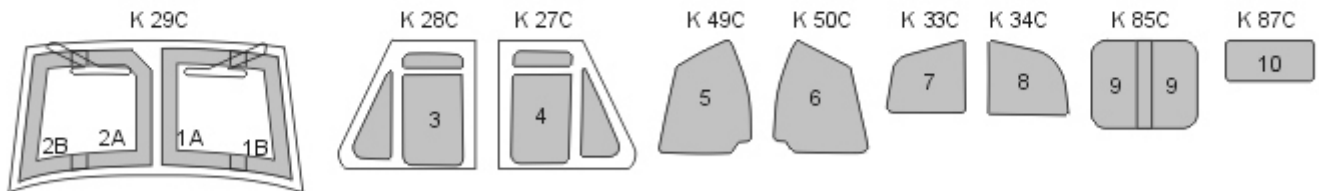

NWAM1213

1/48 scale



Bell AB 212 / UH-1N EXPERT kabuki masks
for Italeri 2692, 847 and Heller 80413 kits
<http://mek.kosmo.cz/newware>

Includes also windows inner side
and antiglare shield masks

tom.nwkits@seznam.cz

Important:

Let the sprayed color dry before applying masks. Remove masks very carefully after painting.
Where the mask is divided into A and B parts, first apply part A, next part B.
The set does not include masks for all areas, so mask the rest with masking tape or liquid mask.

K kit part

* start placing the mask from this point

Placing wet masks on wet surface is recommended, except those marked by **W**

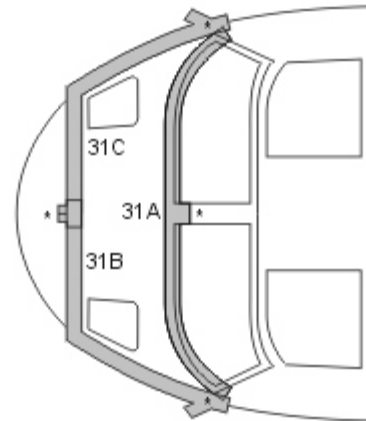
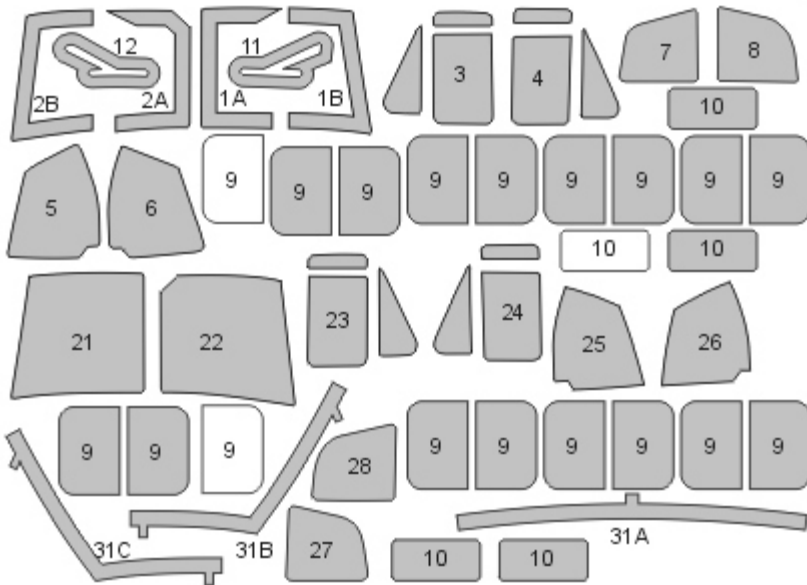

white - spare parts

STEP 1 - exterior view
mask interior, paint interior color

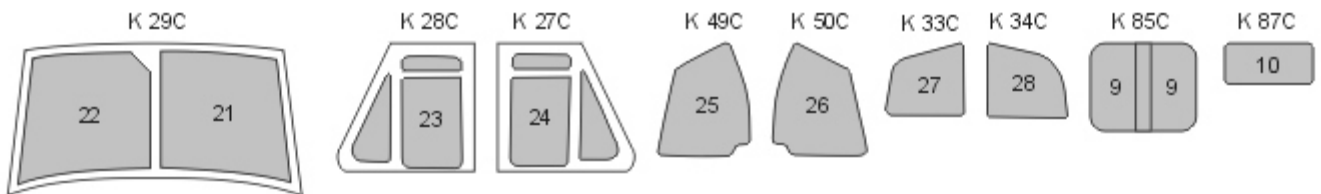

STEP 2
mask exterior, paint camouflage color

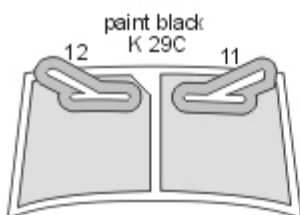
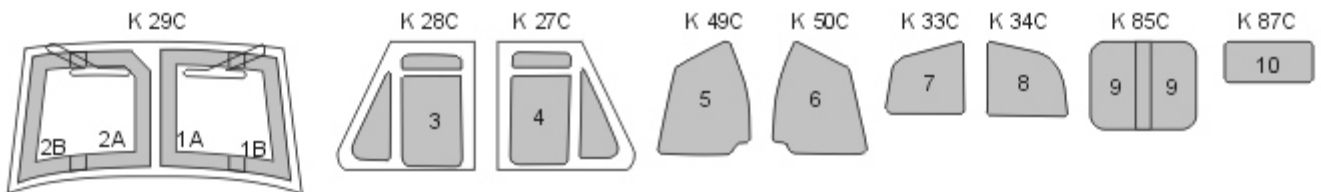

NWAM1214

1/72 scale



Tu-2 (S) kabuki masks

for kits based ICM 72031 with original clear parts, see explanation below

including Sabre Kits SBK7035 and SBK7036

<http://mek.kosmo.cz/newware>

tom.nwkits@seznam.cz

Important:

Let the sprayed color dry before applying masks. Remove masks very carefully after painting.

Where the mask is divided into A and B parts, first apply part A, next part B.

The set does not include masks for all areas, so mask the rest with masking tape or liquid mask.

K kit part

^ start placing the mask from this point

Placing wet masks on wet surface is recommended, except those marked by **W**

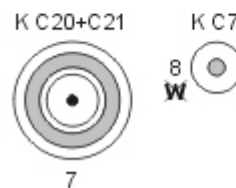
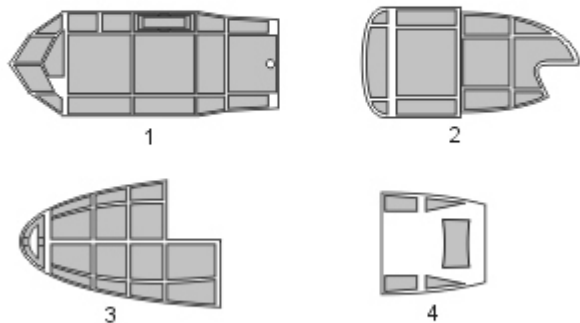
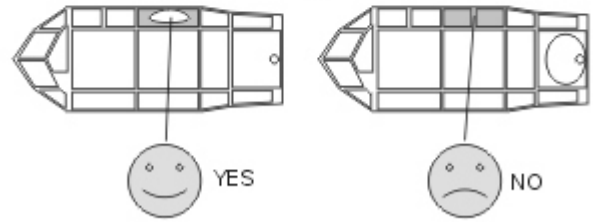
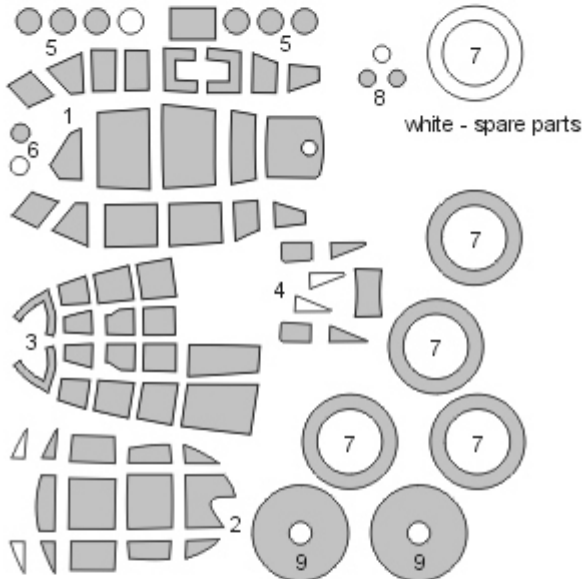

NWAM1215



MiG-29UB ADVANCED kabuki masks

for Academy, Hobby2000, Kora and other based on 2119 kit

<http://mek.kosmo.cz/newware>

Includes also windows seal and camouflage details masks 1/48 scale

tom.nwkits@seznam.cz

Important:

Let the sprayed color dry before applying masks. Remove masks very carefully after painting.
Where the mask is divided into A and B parts, first apply part A, next part B.
The set does not include masks for all areas, so mask the rest with masking tape or liquid mask.

K kit part

* start placing the mask from this point

Placing wet masks on wet surface is recommended, except those marked by **W**

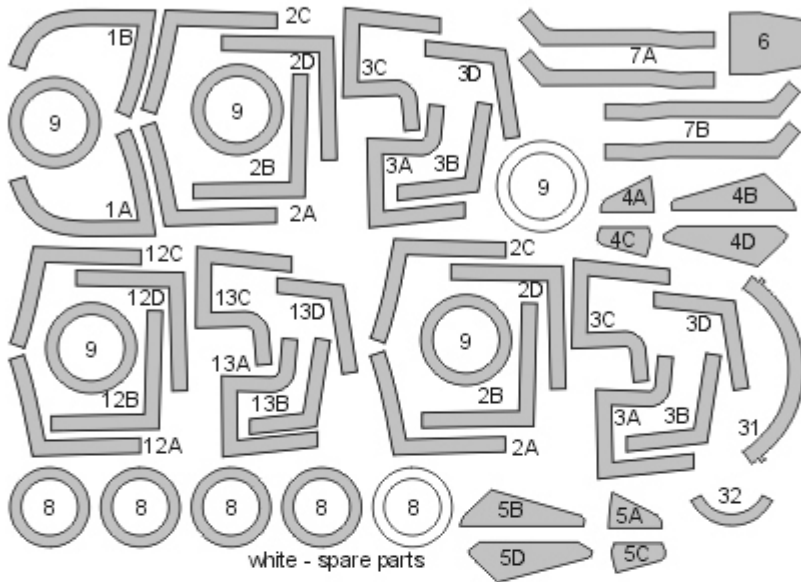

STEP 1
mask exterior, paint interior color

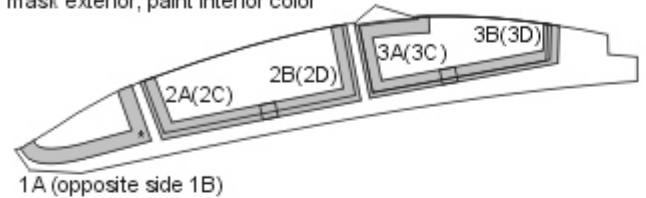

STEP 2
mask exterior, paint seal color (pink)

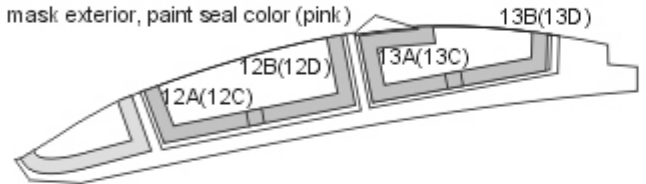

STEP 3
mask exterior, paint camouflage color

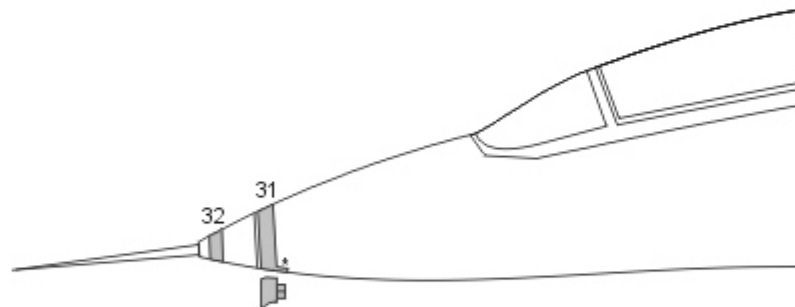
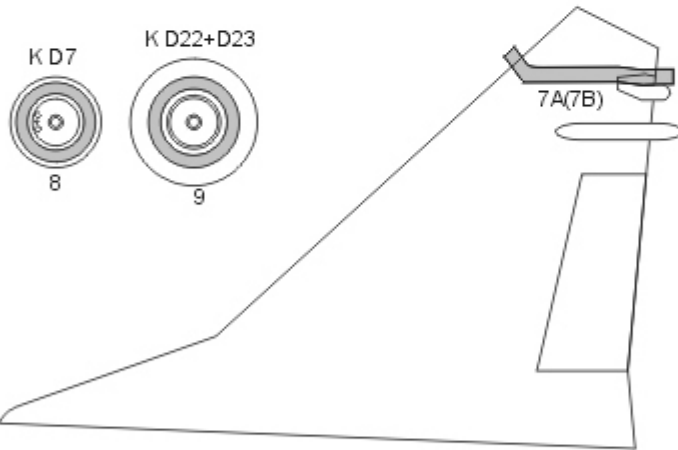
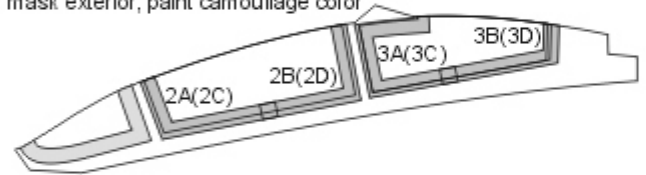

Apply masks 5A and 5B on upper side first, next apply masks 5C and 5D on bottom side

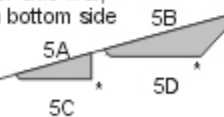

Apply masks 4A and 4B on upper side first, next apply masks 4C and 4D on bottom side

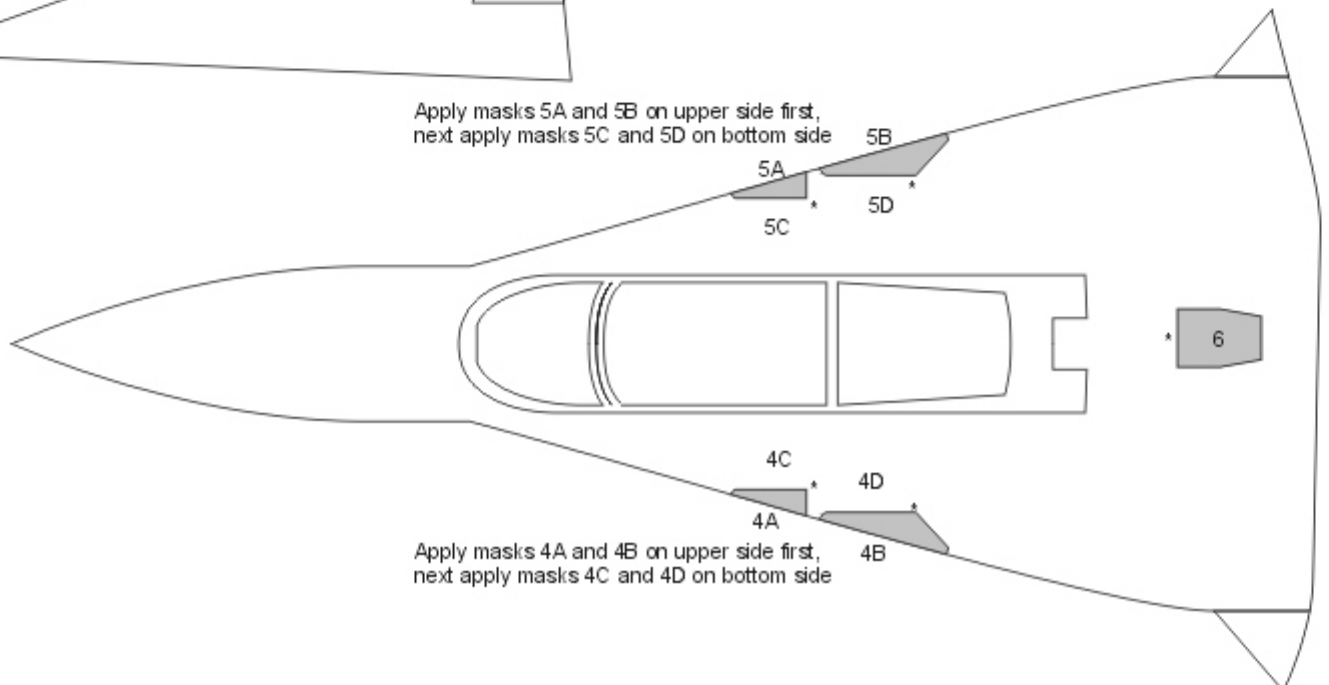
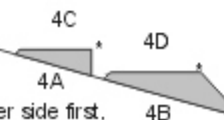

NWAM1216



MiG-29UB EXPERT kabuki masks

for Academy, Hobby2000, Kora and other based on 2119 kit

http://mek.kosmo.cz/new_ware

Includes also windows seal
and inner side masks and
camouflage details masks

1/48 scale

tom.nwkits@seznam.cz

Important:

Let the sprayed color dry before applying masks. Remove masks very carefully after painting.

Where the mask is divided into A and B parts, first apply part A, next part B.

The set does not include masks for all areas, so mask the rest with masking tape or liquid mask.

K kit part

* start placing the mask from this point

Placing wet masks on wet surface is recommended, except those marked by **W**

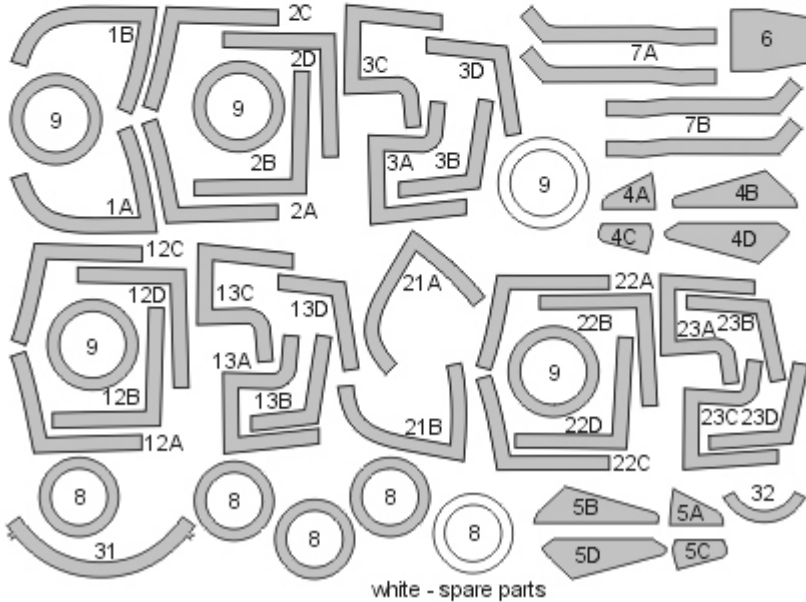

STEP 1 - exterior view
mask interior, paint interior color

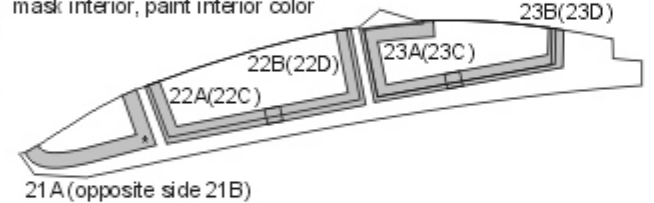

STEP 2
mask exterior, paint seal color (pink)

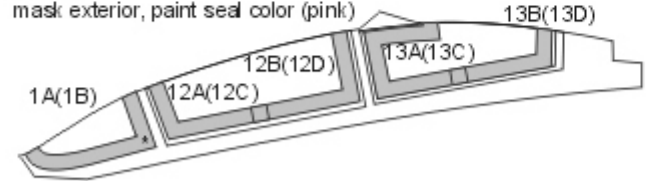

STEP 3
mask exterior, paint camouflage color

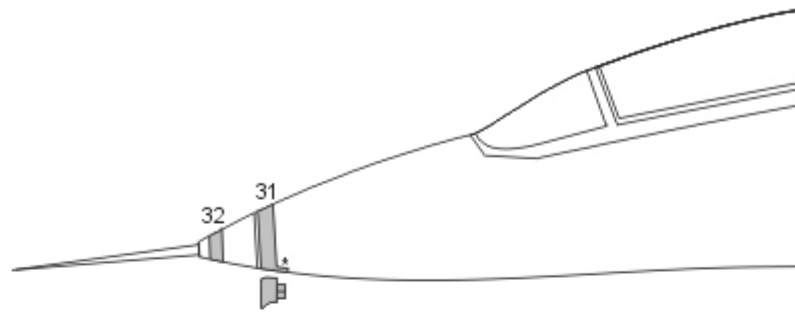
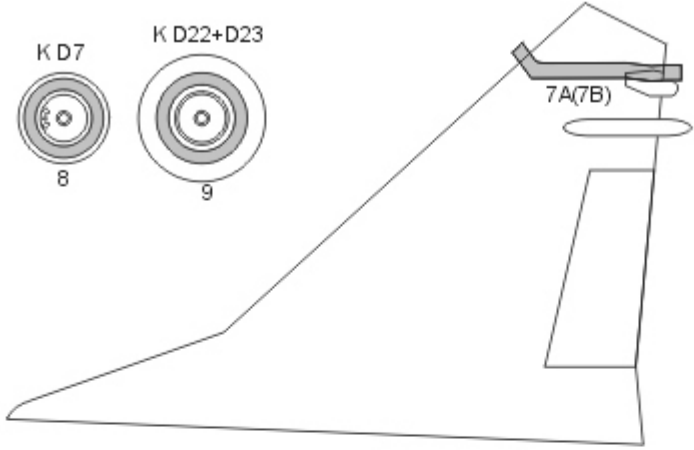
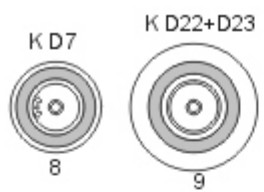
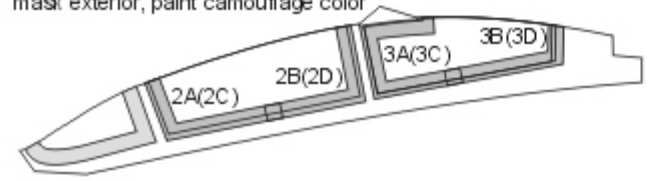

Apply masks 5A and 5B on upper side first,
next apply masks 5C and 5D on bottom side

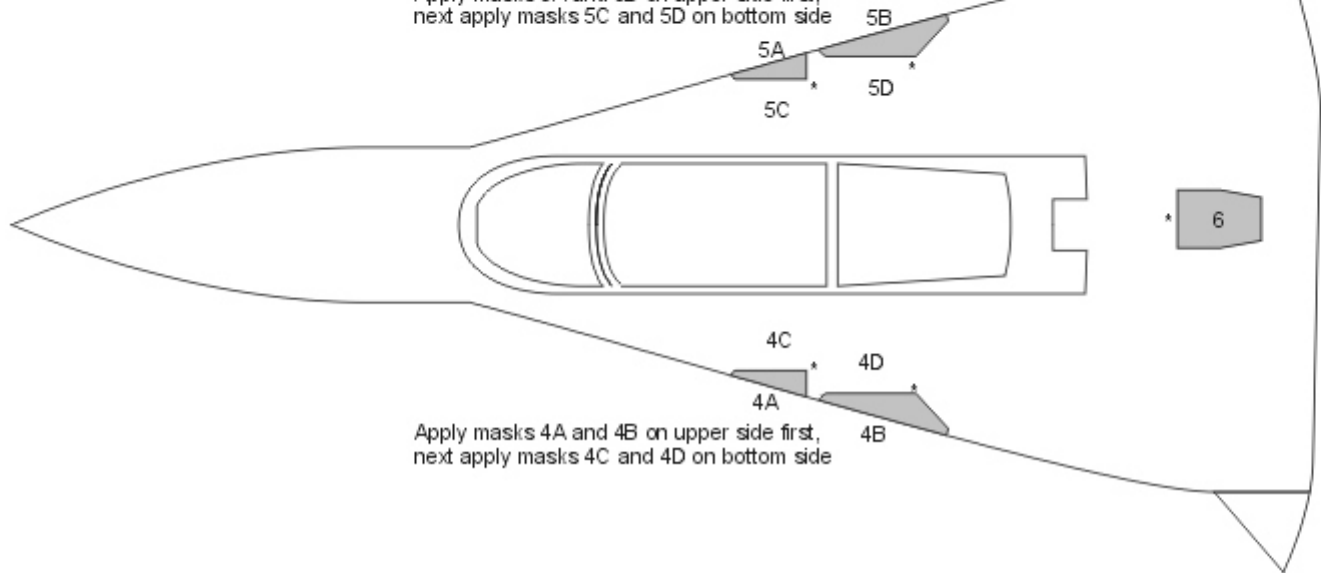

Apply masks 4A and 4B on upper side first,
next apply masks 4C and 4D on bottom side