



# NEW WARE NEWSLETTER

## NEW MASKS MARCH 2024

NWAM1181 1/72 RF-8A/ RF-8G ADVANCED kabuki masks	Sword	SW72149, SW72150
NWAM1182 1/72 RF-8A/ RF-8G EXPERT kabuki masks	Sword	SW72149, SW72150
NWAM1183 1/48 T-45A/ C Goshawk BASIC kabuki masks	Kinetic	K48038, K48094, other
NWAM1184 1/48 T-45A/ C Goshawk ADVANCED kabuki masks	Kinetic	K48038, K48094, other
NWAM1185 1/48 T-45A/ C Goshawk EXPERT kabuki masks	Kinetic	K48038, K48094, other
NWAM1186 1/72 Mig-19/ Shenyang F-6/ J-6 BASIC kabuki masks	Kovozavody Prostejov	All KP Mig-19 kits
NWAM1187 1/72 Mig-19/ Shenyang F-6/ J-6 EXPERT kabuki masks	Kovozavody Prostejov	All KP Mig-19 kits
NWAM1188 1/48 YF-23 BASIC kabuki masks	HobbyBoss	81722
NWAM1189 1/48 YF-23 EXPERT kabuki masks	HobbyBoss	81722
NWAM1190 1/48 Yak-9T BASIC kabuki masks	Zvezda	4831
NWAM1191 1/48 Yak-9T EXPERT kabuki masks	Zvezda	4831
NWAM1192 1/48 Mi G-21 bi s/ MF/ MFN/ PFM/ R/ SMT BASIC kabuki masks	Eduard	Mi G-21 kits
NWAM1193 1/48 Mi G-21 bi s/ MF/ MFN/ SMT ADVANCED kabuki masks	Eduard	Mi G-21 kits
NWAM1194 1/48 Mi G-21 bi s/ MF/ MFN/ SMT EXPERT kabuki masks	Eduard	Mi G-21 kits
NWAM1195 1/48 Yak-28PP Brewer-EBASIC kabuki masks	HobbyBoss	81768
NWAM1196 1/48 Yak-28PP Brewer-EADVANCED kabuki masks	HobbyBoss	81768
NWAM1197 1/48 Yak-28PP Brewer-EEXPERT kabuki masks	HobbyBoss	81768
NWAM1198 1/48 Ju 88P-1 BASIC kabuki masks	ICM	48224
NWAM1199 1/48 Ju 88P-1 EXPERT kabuki masks	ICM	48224
NWAM1200 1/48 Ju 88P-1 NATIONAL INSIGNIA kabuki masks	ICM	48224
NWAM1201 1/48 Mi G-29 ADVANCED kabuki masks	Academy, Hbbby2000, Kora	kit s based on Academy 2116kit
NWAM1202 1/48 Mi G-29 EXPERT kabuki masks	Academy, Hbbby2000, Kora	kit s based on Academy 2116kit



RF-8A/RF-8G ADVANCED kabuki masks  
for Sword SW72150 and SW72149 kits  
<http://mek.kosmo.cz/newware>

INCLUDES ALSO  
WINDOWS SEAL  
AND CAMOUFLAGE DETAILS MASKS

tom.nwkits@seznam.cz

**Important:**

Let the sprayed color dry before applying masks. Remove masks very carefully after painting. Where the mask is divided into A and B parts, first apply part A, next part B. The set does not include masks for all areas, so mask the rest with masking tape or liquid mask.

K kit part

\* start placing the mask from this point

Placing wet masks on wet surface is recommended, except those marked by **W**

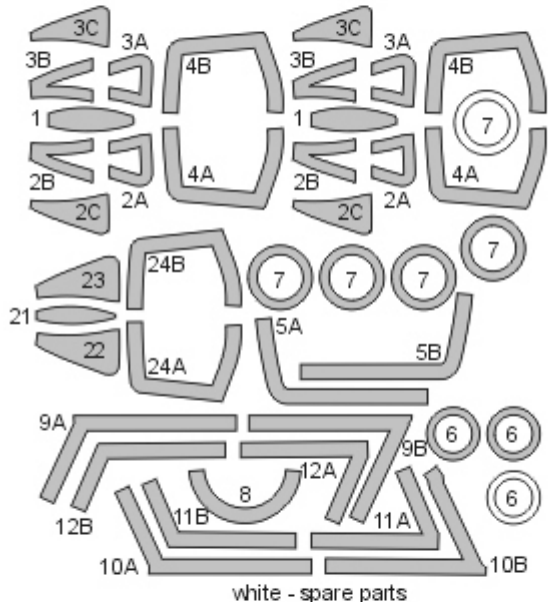

STEP 1  
paint interior color

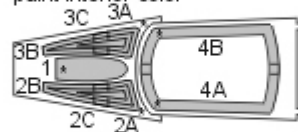

STEP 2  
paint window seal color

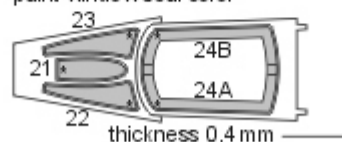

STEP 3  
paint camouflage color

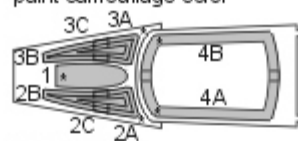

STEP 4  
add masks 5, paint black

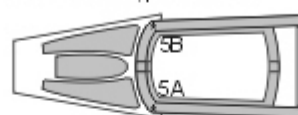

mask white nose

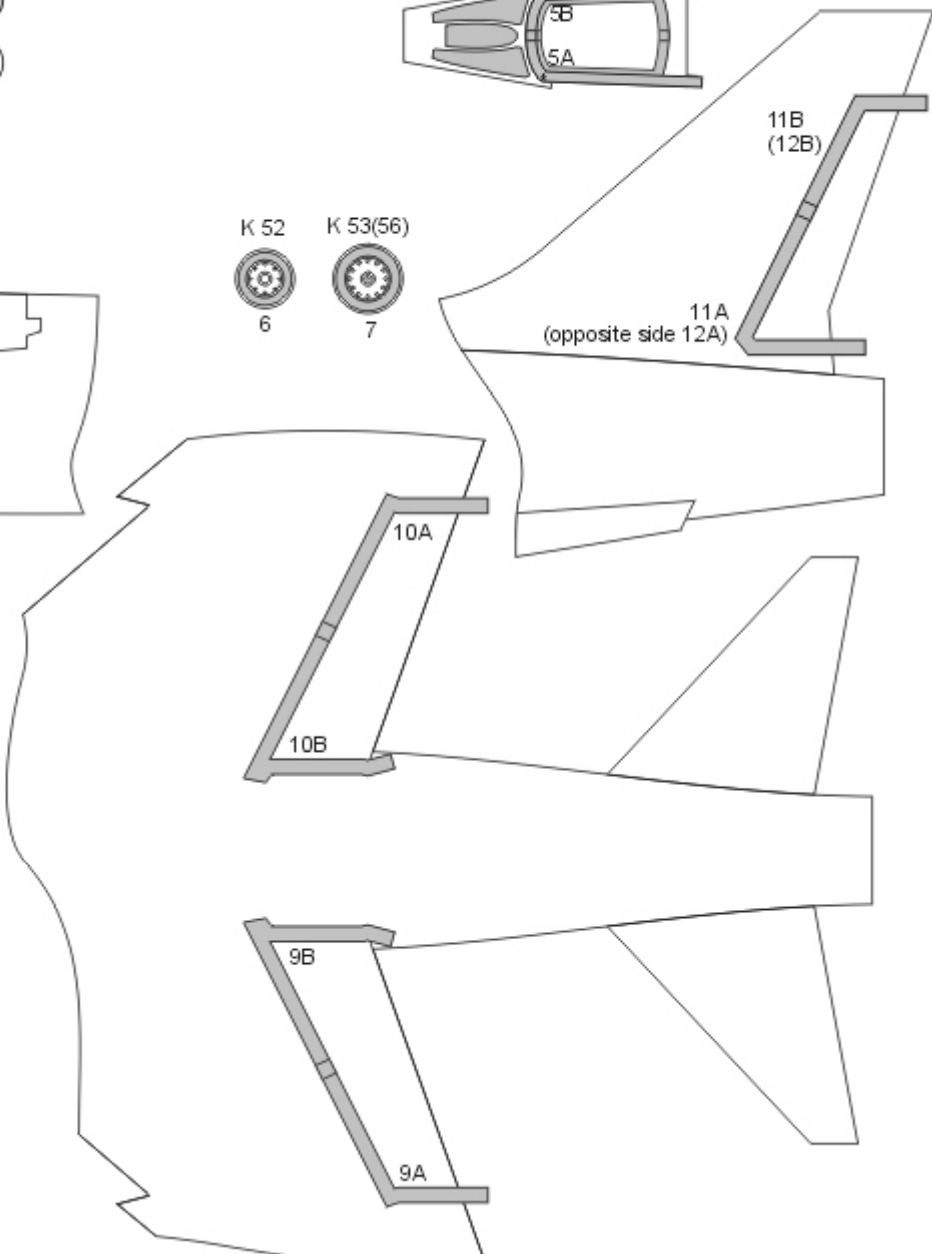

# NWAM1182



RF-8A/RF-8G EXPERT kabuki masks  
for Sword SW72150 and SW72149 kits  
<http://mek.kosmo.cz/newware>

INCLUDES ALSO  
WINDOWS SEAL AND INNER SIDE MASKS  
AND CAMOUFLAGE DETAILS

1/72 scale

tom.nwkits@seznam.cz

### Important:

Let the sprayed color dry before applying masks. Remove masks very carefully after painting.  
Where the mask is divided into A and B parts, first apply part A, next part B.  
The set does not include masks for all areas, so mask the rest with masking tape or liquid mask.

K kit part

\* start placing the mask from this point

Placing wet masks on wet surface is recommended, except those marked by **W**

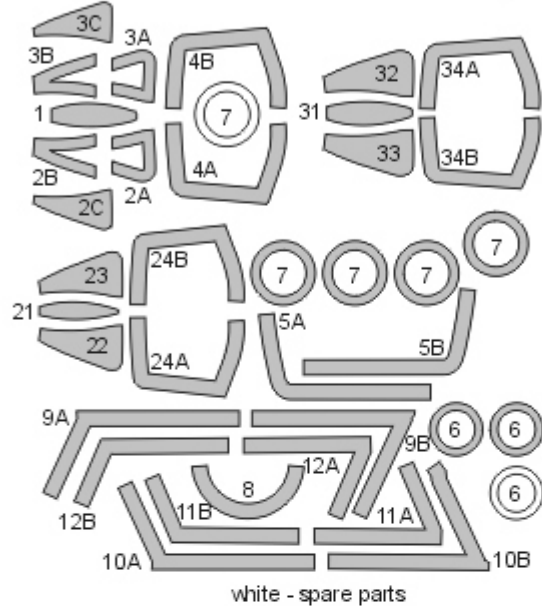

STEP 1 (exterior view)  
mask interior, paint interior color

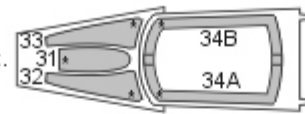

STEP 2  
mask exterior, paint window seal color



STEP 3  
mask exterior, paint grey

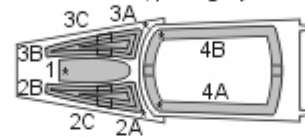

STEP 4  
add masks 5, paint black

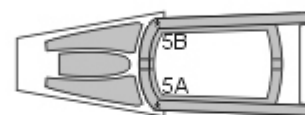

mask white nose

8

11A  
(opposite side 12A)

11B  
(12B)

10A

10B

9B

9A



T-45 A/C Goshawk BASIC kabuki masks  
 for Kinetic K48038, K48094 and other kits  
<http://mek.kosmo.cz/newware>

tom.nwkits@seznam.cz

**Important:**

Let the sprayed color dry before applying masks. Remove masks very carefully after painting.  
 Where the mask is divided into A and B parts, first apply part A, next part B.  
 The set does not include masks for all areas, so mask the rest with masking tape or liquid mask.

Kit part

\* start placing the mask from this point

Placing wet masks on wet surface is recommended, except those marked by **W**

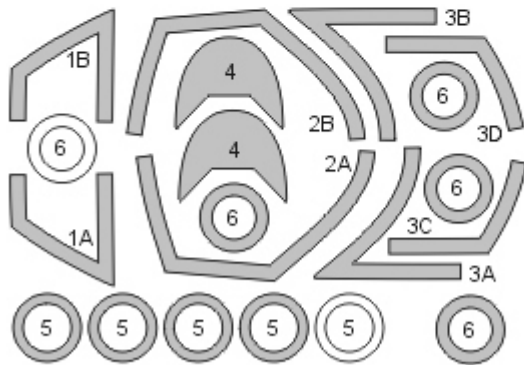

white - spare parts

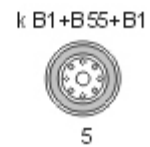
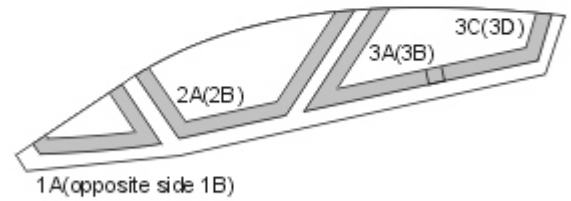



# NWAM1184

T-45 A/C Goshawk **ADVANCED** kabuki masks  
for Kinetic K48038, K48094 and other kits  
<http://mek.kosmo.cz/newware>

INCLUDES ALSO  
WINDOWS SEAL AND CAMOUFLAGE  
DETAILS MASKS

1/48 scale

tom.nwkits@seznam.cz

### Important:

Let the sprayed color dry before applying masks. Remove masks very carefully after painting.  
Where the mask is divided into A and B parts, first apply part A, next part B.  
The set does not include masks for all areas, so mask the rest with masking tape or liquid mask.

K kit part

\* start placing the mask from this point

Placing wet masks on wet surface is recommended, except those marked by **W**

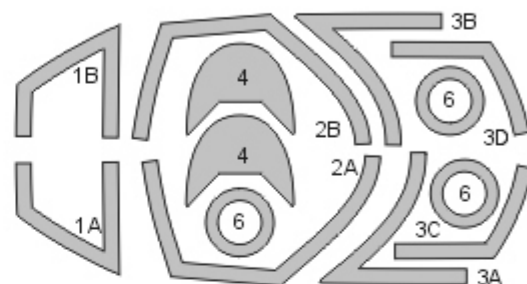
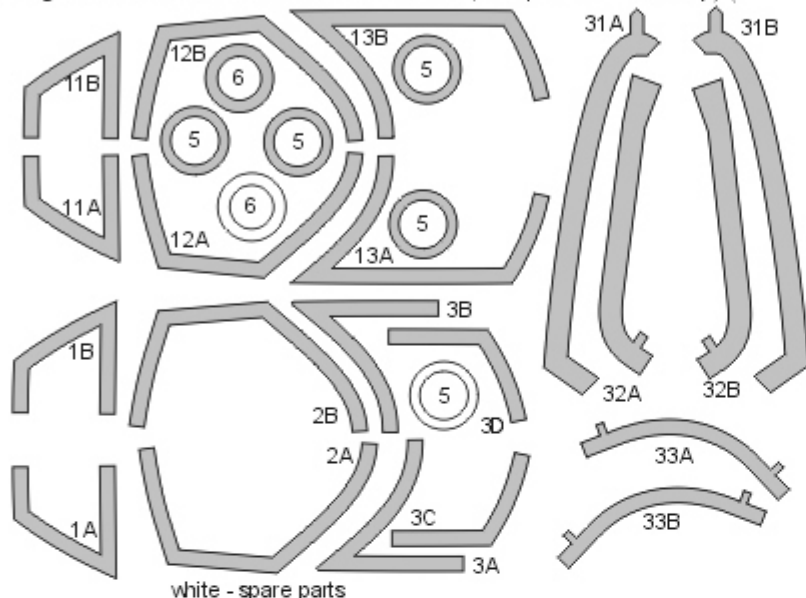

white - spare parts

STEP 1  
paint interior color

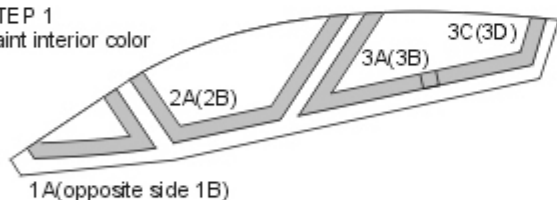

1A(opposite side 1B)

STEP 2  
paint seal color

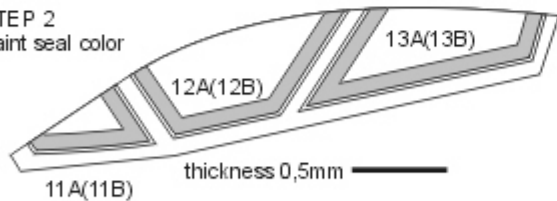

11A(11B)

STEP 3  
paint camouflage color

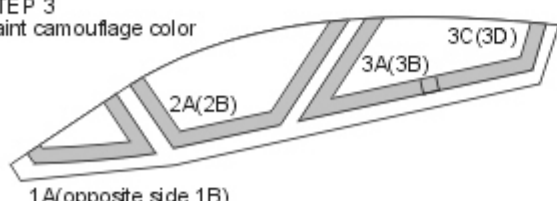

1A(opposite side 1B)



k B1+B55+B1

k D21+D50+D22

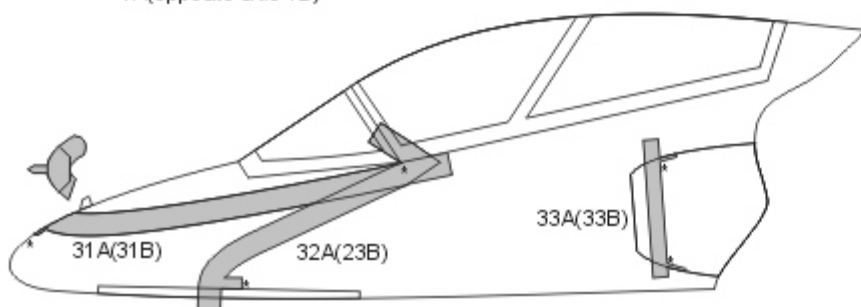

# NWAM1185



T-45 A/C Goshawk EXPERT kabuki masks  
 for Kinetic K48038, K48094 and other kits  
<http://mek.kosmo.cz/newware>

INCLUDES ALSO  
 WINDOWS SEAL AND INNER SIDE MASKS  
 AND CAMOUFLAGE DETAILS MASKS

1/48 scale

tom.nwkits@seznam.cz

**Important:**

Let the sprayed color dry before applying masks. Remove masks very carefully after painting.  
 Where the mask is divided into A and B parts, first apply part A, next part B.  
 The set does not include masks for all areas, so mask the rest with masking tape or liquid mask.

K kit part

\* start placing the mask from this point

Placing wet masks on wet surface is recommended, except those marked by **W**

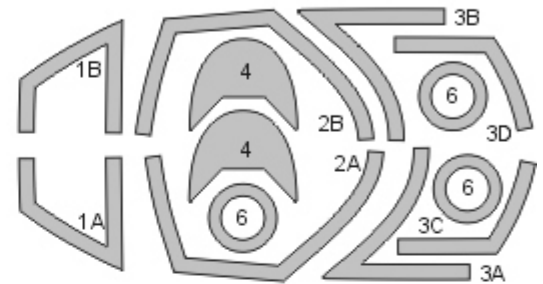
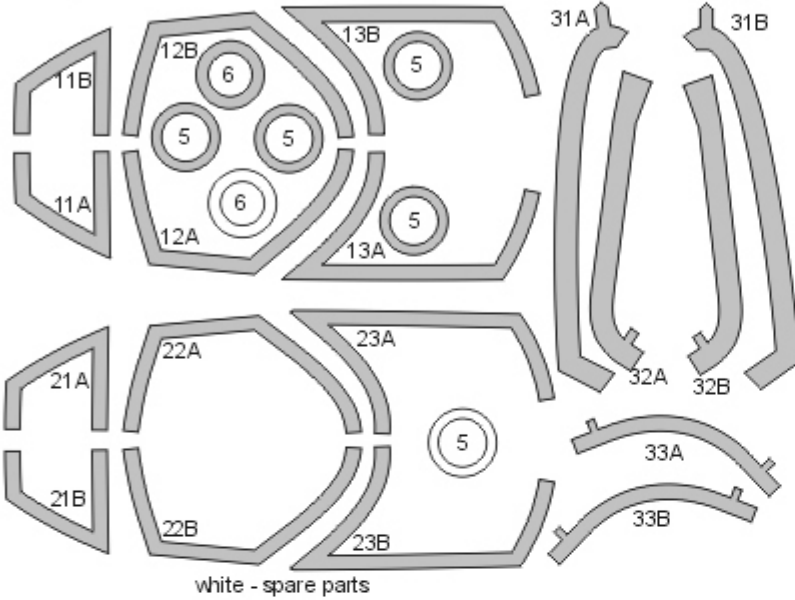

STEP 1 - exterior view  
 mask interior, paint interior color

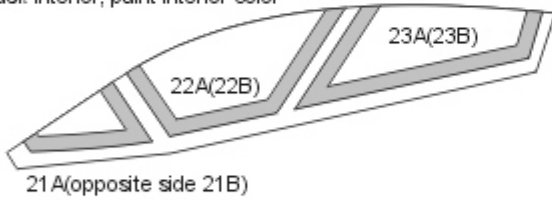

k B1+B55+B1

k D21+D50+D22

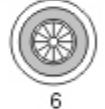

STEP 2  
 mask exterior, paint seal color

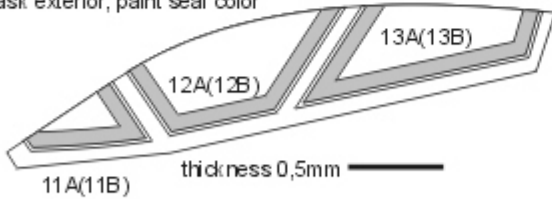

STEP 3  
 mask exterior, paint camouflage color

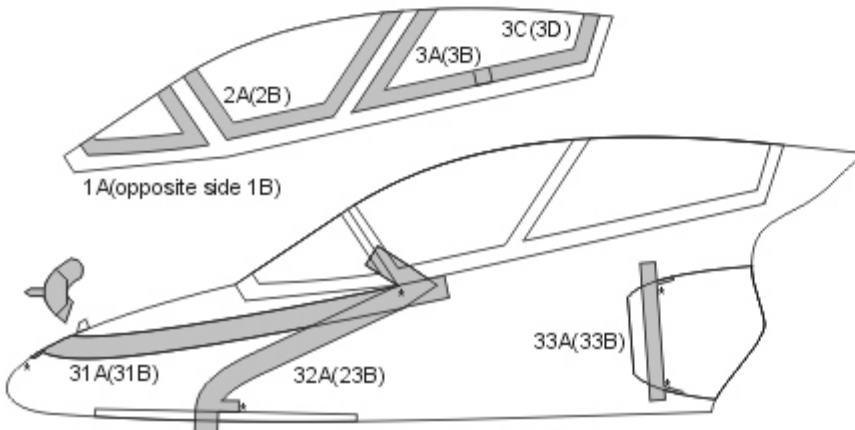



## MiG-19 / Shenyang F-6/J-6 BASIC kabuki masks

for Kozovavody Prostejov all MiG-19 kits

<http://mek.kosmo.cz/newware>

tom.nwkits@seznam.cz

### Important:

Let the sprayed color dry before applying masks. Remove masks very carefully after painting.  
Where the mask is divided into A and B parts, first apply part A, next part B.  
The set does not include masks for all areas, so mask the rest with masking tape or liquid mask.

Kit part

\* start placing the mask from this point

Placing wet masks on wet surface is recommended, except those marked by **W**

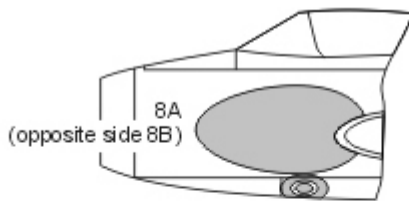
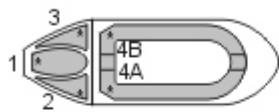
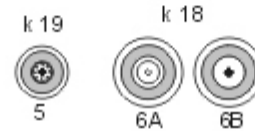
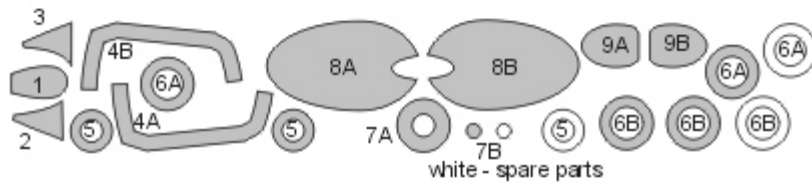

8A(8B) ? 9A(9B)

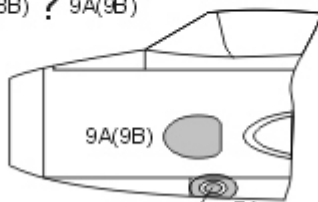

apply mask 7A 7B 7A  
paint silver  
add mask 7B  
paint black



MiG-19 / Shenyang F-6/J-6 EXPERT kabuki masks  
 for KovoZavody Prostejov all MiG-19 kits  
<http://mek.kosmo.cz/newware>

INCLUDES ALSO  
 WINDOWS INNER SIDE MASKS

tom.nwkits@seznam.cz

**Important:**

Let the sprayed color dry before applying masks. Remove masks very carefully after painting.  
 Where the mask is divided into A and B parts, first apply part A, next part B.  
 The set does not include masks for all areas, so mask the rest with masking tape or liquid mask.

Kit part

\* start placing the mask from this point

Placing wet masks on wet surface is recommended, except those marked by **W**

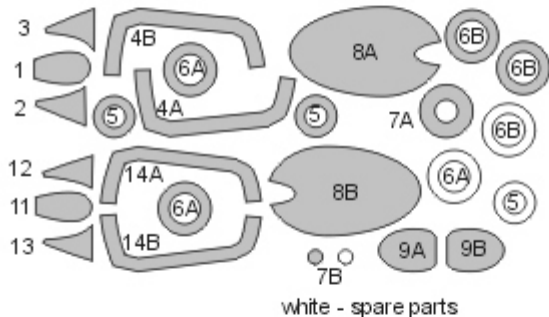

STEP 1 (exterior view)

mask interior, paint interior color

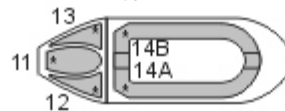

STEP 2

mask exterior, paint camouflage color

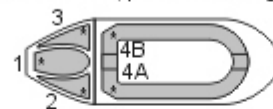

k 19



k 18

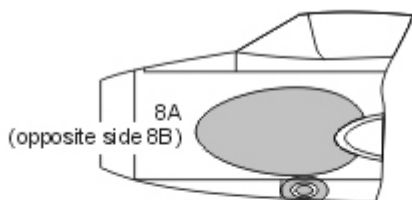
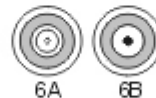

8A(8B) ? 9A(9B)

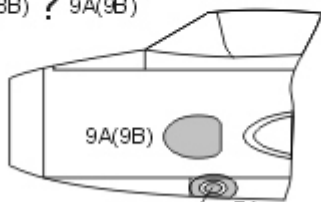

apply mask 7A  
 paint silver  
 add mask 7B  
 paint black





YF-23 BASIC kabuki masks

for HobbyBoss no. 81722 kit

<http://mek.kosmo.cz/newware>

tom.nwkits@seznam.cz

**Important:**

Let the sprayed color dry before applying masks. Remove masks very carefully after painting.

Where the mask is divided into A and B parts, first apply part A, next part B.

The set does not include masks for all areas, so mask the rest with masking tape or liquid mask.

K kit part

\* start placing the mask from this point

Placing wet masks on wet surface is recommended, except those marked by **W**

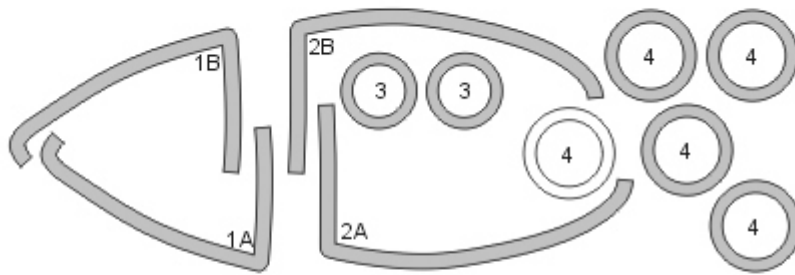

white - spare parts

K D1+D2



3

K D28+D29(D35+D36)



4

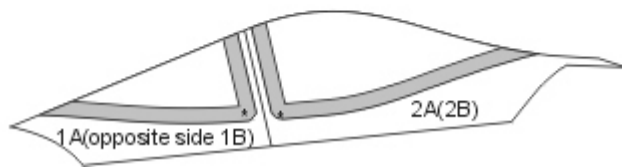

# NWAM1189

1/48 scale



YF-23 EXPERT kabuki masks

for HobbyBoss no. 81722 kit

<http://mek.kosmo.cz/newware>

INCLUDES ALSO  
WINDOWS INNER SIDE MASKS

tom.nwkits@seznam.cz

### Important:

Let the sprayed color dry before applying masks. Remove masks very carefully after painting. Where the mask is divided into A and B parts, first apply part A, next part B. The set does not include masks for all areas, so mask the rest with masking tape or liquid mask.

K kit part

\* start placing the mask from this point

Placing wet masks on wet surface is recommended, except those marked by **W**

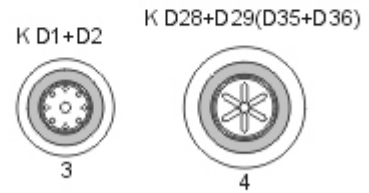
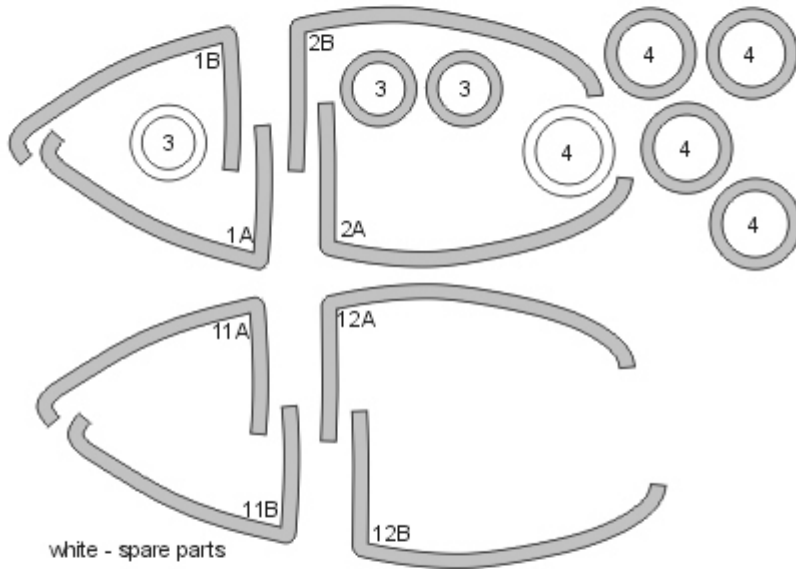

STEP 1 - exterior view  
mask interior, paint interior color

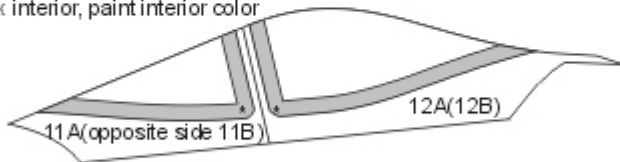

STEP 2  
mask exterior, paint camouflage color

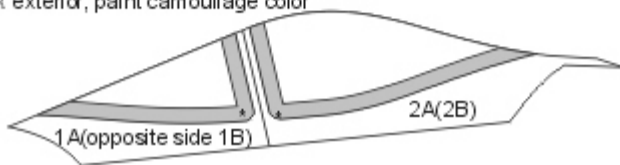



## Yak-9T BASIC kabuki masks

for Zvezda 4831 kit

<http://mek.kosmo.cz/newware>

tom.nwkits@seznam.cz

### Important:

Let the sprayed color dry before applying masks. Remove masks very carefully after painting.

Where the mask is divided into A and B parts, first apply part A, next part B.

The set does not include masks for all areas, so mask the rest with masking tape or liquid mask.

K kit part

\* start placing the mask from this point

Placing wet masks on wet surface is recommended, except those marked by **W**

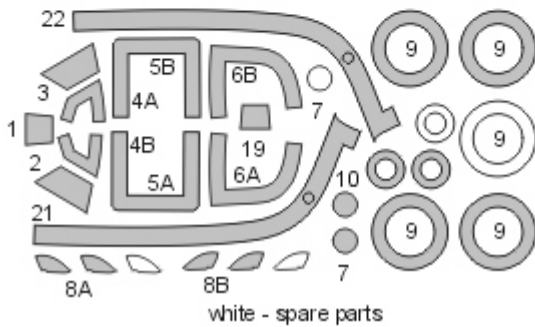

K B10+24+17+20, B10+24+17+21 K B18



K D7

K D8

K D2, D3

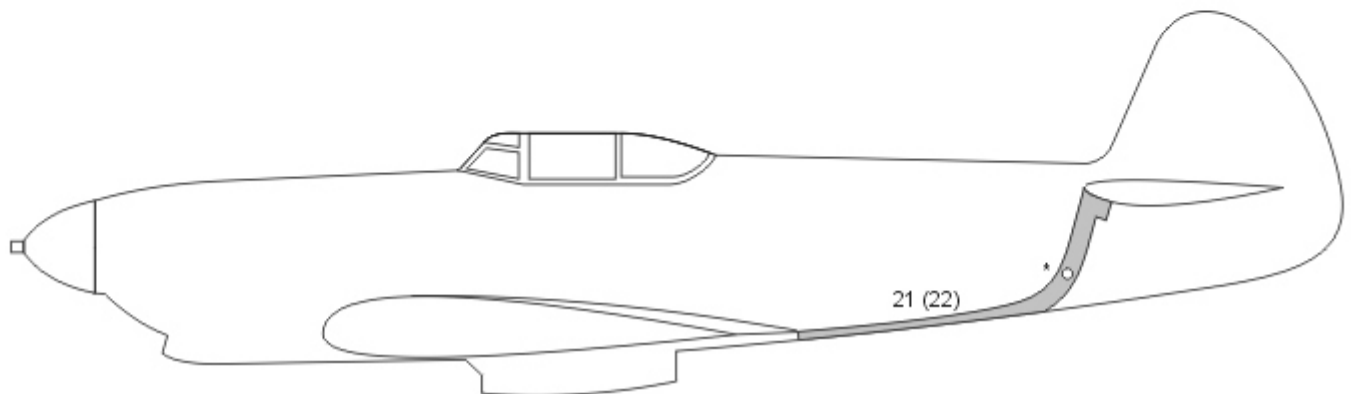
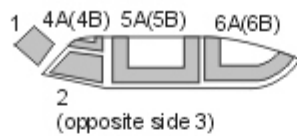



Yak-9T EXPERT kabuki masks

for Zvezda 4831 kit

<http://mek.kosmo.cz/newware>

INCLUDES ALSO  
WINDOWS INNER SIDE MASKS

tom.nwkits@seznam.cz

**Important:**

Let the sprayed color dry before applying masks. Remove masks very carefully after painting.  
Where the mask is divided into A and B parts, first apply part A, next part B.  
The set does not include masks for all areas, so mask the rest with masking tape or liquid mask.

K kit part

\* start placing the mask from this point

Placing wet masks on wet surface is recommended, except those marked by **W**

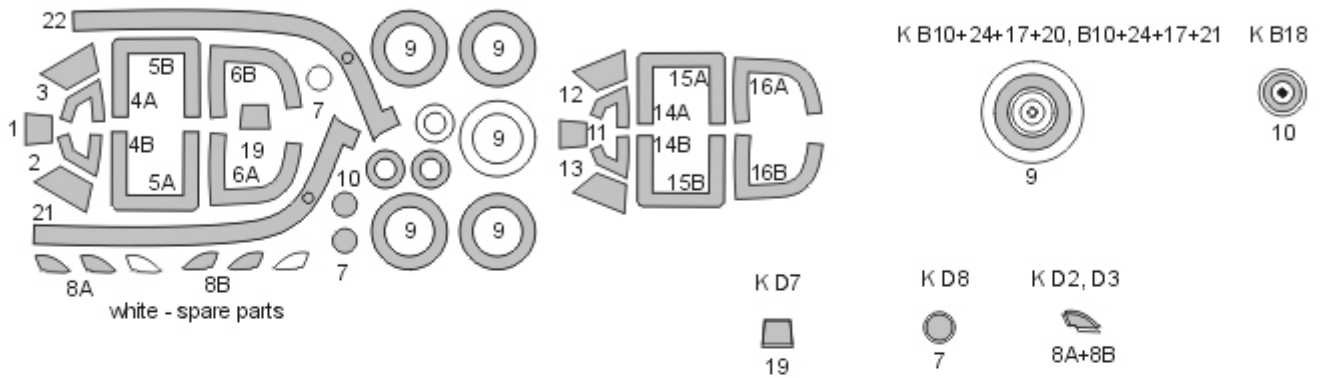

STEP 1 - exterior view  
mask interior, paint interior color

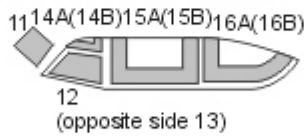

STEP 2  
mask exterior, paint camouflage color

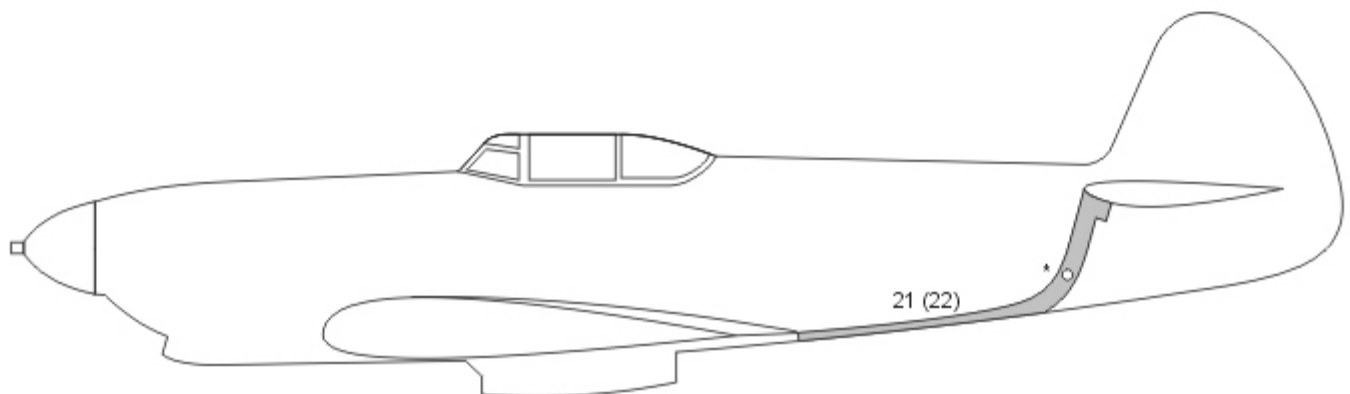
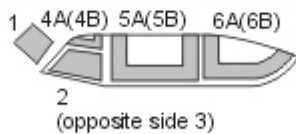



**Important:**

Let the sprayed color dry before applying masks. Remove masks very carefully after painting.  
 Where the mask is divided into A and B parts, first apply part A, next part B.  
 The set does not include masks for all areas, so mask the rest with masking tape or liquid mask.

K kit part

^ start placing the mask from this point

Placing wet masks on wet surface is recommended, except those marked by **W**

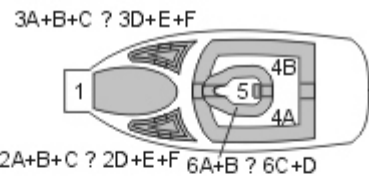
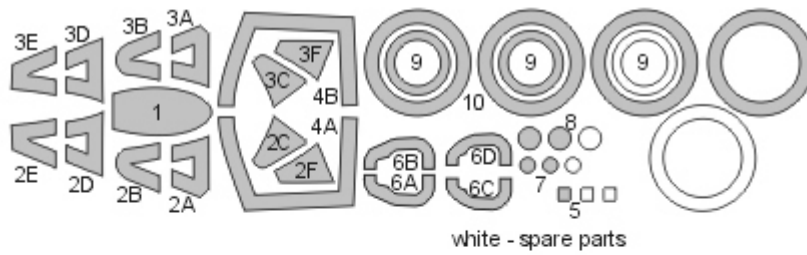

K G 11:      K G 12  
 2(3)A+B+C    2(3)E+D+F  
 K G 17:      K G 16  
 6A+B          6C+D

K D 21+D15+D16+D22    K D 12(D13)+D77+D76+D14+D17(D18)





INCLUDES ALSO  
WINDOWS SEAL  
AND CAMOUFLAGE MASKS

tom.nwkits@seznam.cz

**Important:**

Let the sprayed color dry before applying masks. Remove masks very carefully after painting.  
Where the mask is divided into A and B parts, first apply part A, next part B.  
The set does not include masks for all areas, so mask the rest with masking tape or liquid mask.

K kit part

\* start placing the mask from this point

Placing wet masks on wet surface is recommended, except those marked by **W**

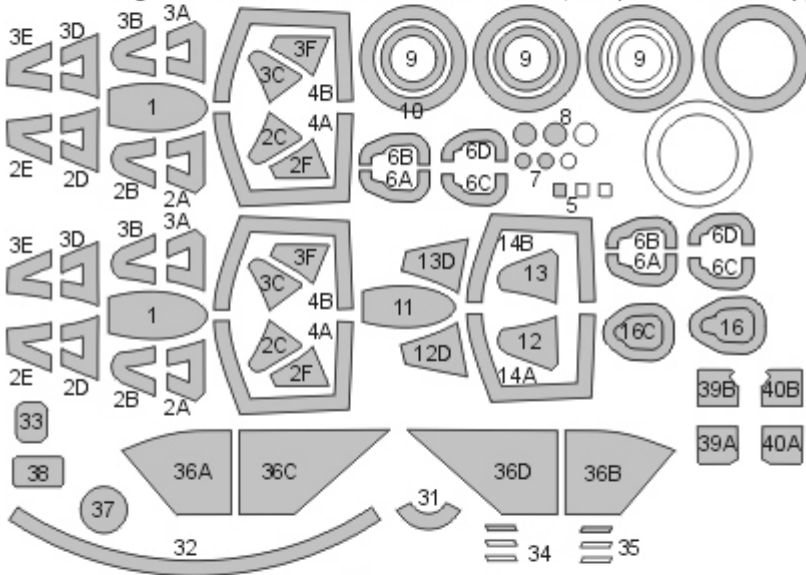

white - spare parts

STEP 1  
mask exterior, paint interior color  
3A+B+C ? 3D+E+F



2A+B+C ? 2D+E+F 6A+B ? 6C+D

STEP 2  
mask exterior, paint seal color



STEP 3  
mask exterior, paint camouflage color  
3A+B+C ? 3D+E+F



2A+B+C ? 2D+E+F 6A+B ? 6C+D

K D21+D15+D16+D22    K D12(D13)+D77+D76+D14+D17(D18)



9



10

K G7    K G2  
**W** 7    **W** 8

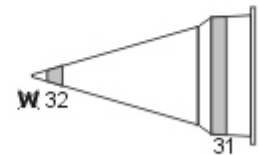

31

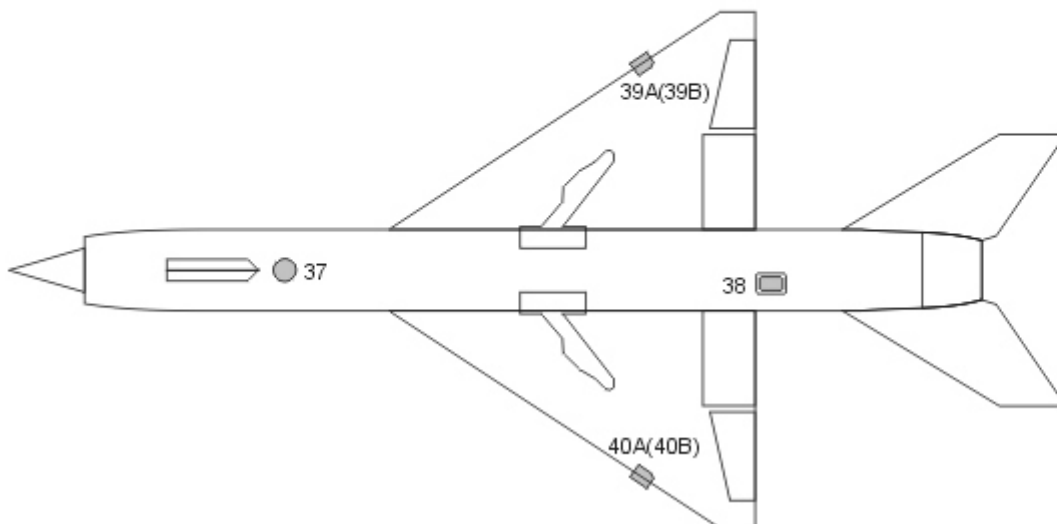
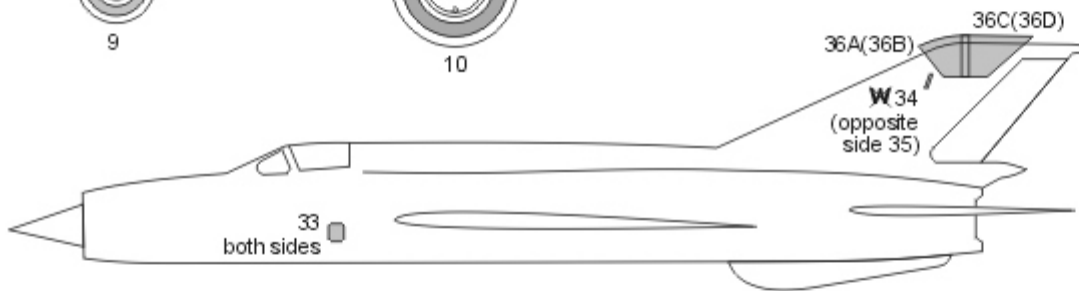



MiG-21 bis/MF/MFN/SMT EXPERT kabuki masks  
for Eduard MiG-21 kits  
<http://mek.kosmo.cz/newware>

INCLUDES ALSO  
WINDOWS SEAL AND INNER SIDE  
MASKS AND CAMOUFLAGE MASKS

tom.nwkits@seznam.cz

**Important:**

Let the sprayed color dry before applying masks. Remove masks very carefully after painting.  
Where the mask is divided into A and B parts, first apply part A, next part B.  
The set does not include masks for all areas, so mask the rest with masking tape or liquid mask.

K kit part

\* start placing the mask from this point

Placing wet masks on wet surface is recommended, except those marked by **W**

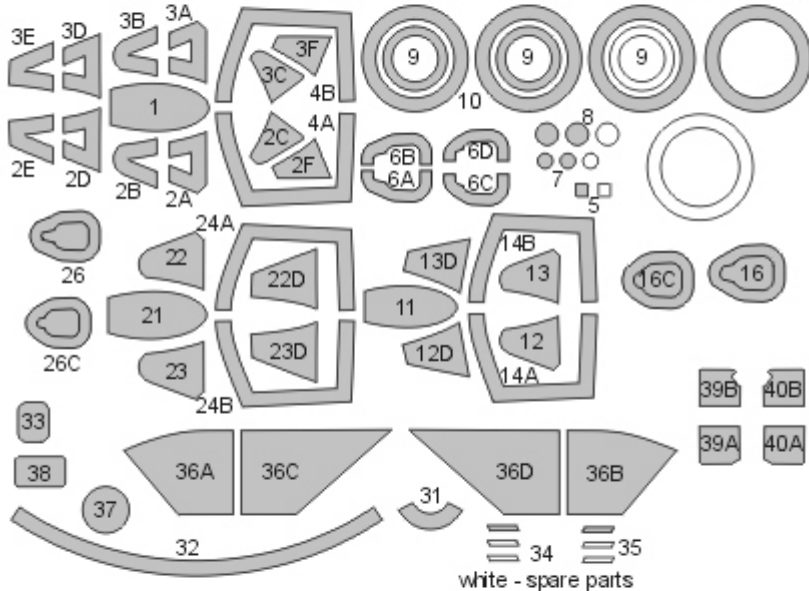

white - spare parts

K G 11:  
2(3)A+B+C  
12(13)  
22(23)

K G 17:  
6A+B  
16  
26

K G 12:  
2(3)E+D+F  
12(13)D  
22(23)D

K G 16:  
6C+D  
16C  
26C

STEP 1 - exterior view  
mask interior, paint interior color

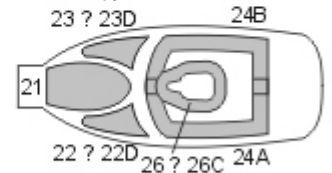

STEP 2  
mask exterior, paint seal color

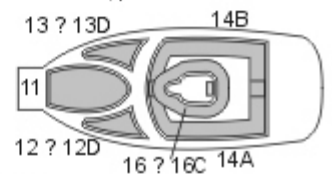

STEP 3  
mask exterior, paint camouflage color



K D 21+D15+D16+D22    K D 12(D13)+D77+D76+D14+D17(D18)



K G 7    K G 2  
**W** 7    **W** 8

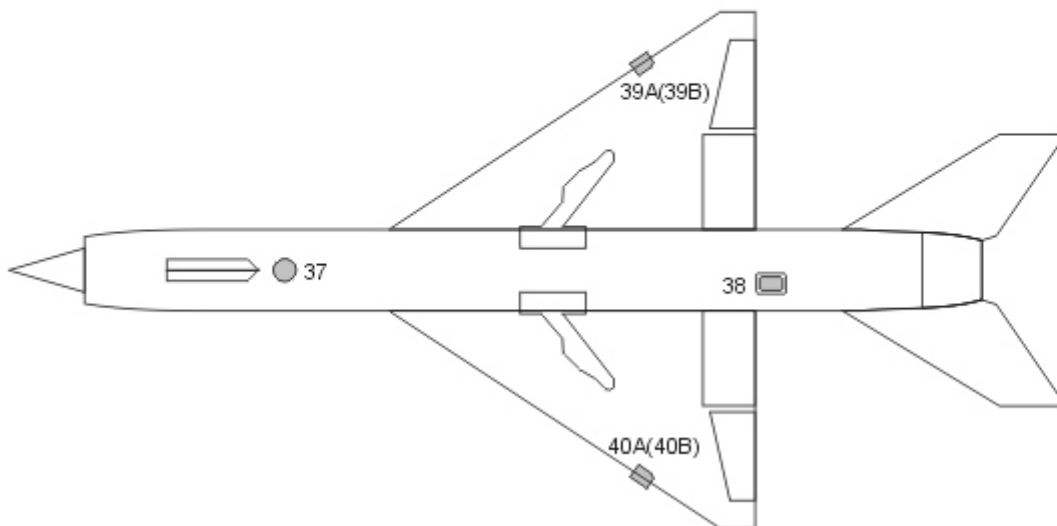
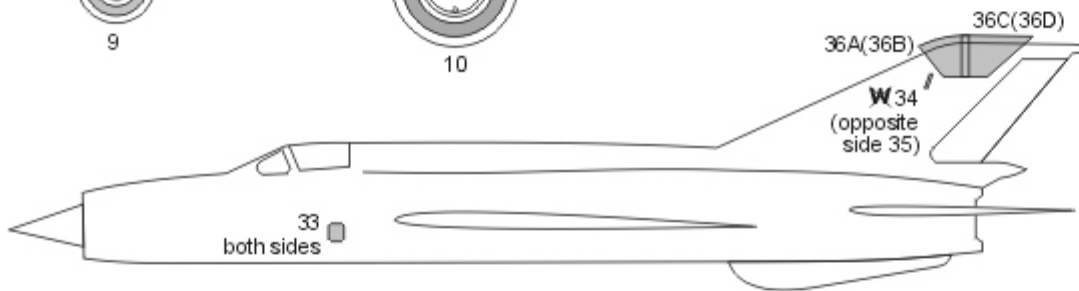
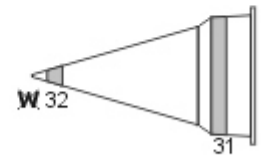



Yak-28PP Brewer-E BASIC kabuki masks

for HobbyBoss 81768 kit

<http://mek.kosmo.cz/newware>

tom.nwkits@seznam.cz

**Important:**

Let the sprayed color dry before applying masks. Remove masks very carefully after painting.  
 Where the mask is divided into A and B parts, first apply part A, next part B.  
 The set does not include masks for all areas, so mask the rest with masking tape or liquid mask.

K kit part

\* start placing the mask from this point

Placing wet masks on wet surface is recommended, except those marked by **W**

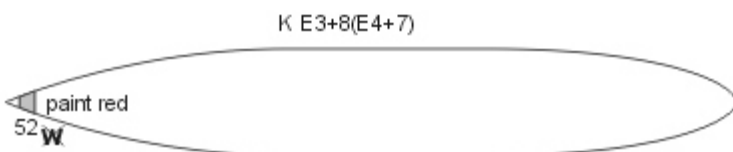
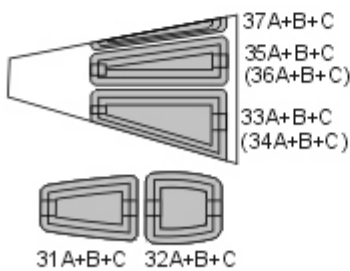
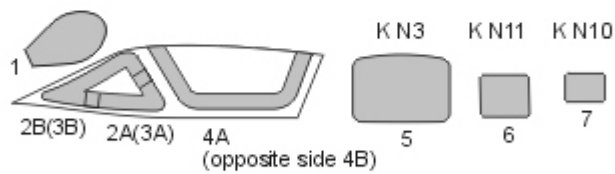
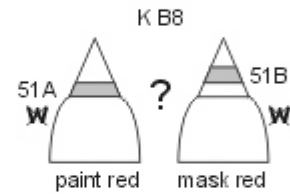
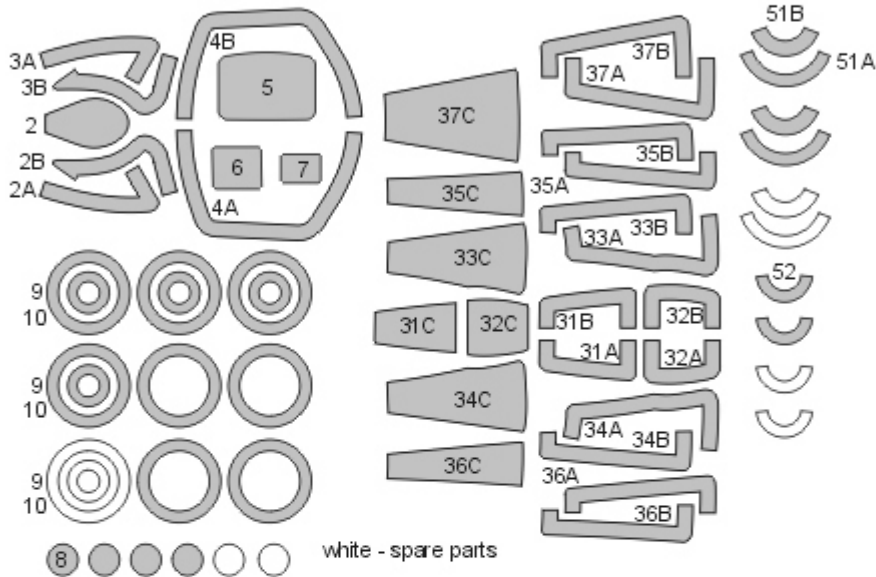





Yak-28PP Brewer-E ADVANCED kabuki masks

for HobbyBoss 81768 kit

<http://mek.kosmo.cz/newware>

INCLUDES ALSO  
WINDOWS SEAL MASKS

tom.nwkits@seznam.cz

**Important:**

Let the sprayed color dry before applying masks. Remove masks very carefully after painting.  
Where the mask is divided into A and B parts, first apply part A, next part B.  
The set does not include masks for all areas, so mask the rest with masking tape or liquid mask.

K kit part

\* start placing the mask from this point

Placing wet masks on wet surface is recommended, except those marked by **W**

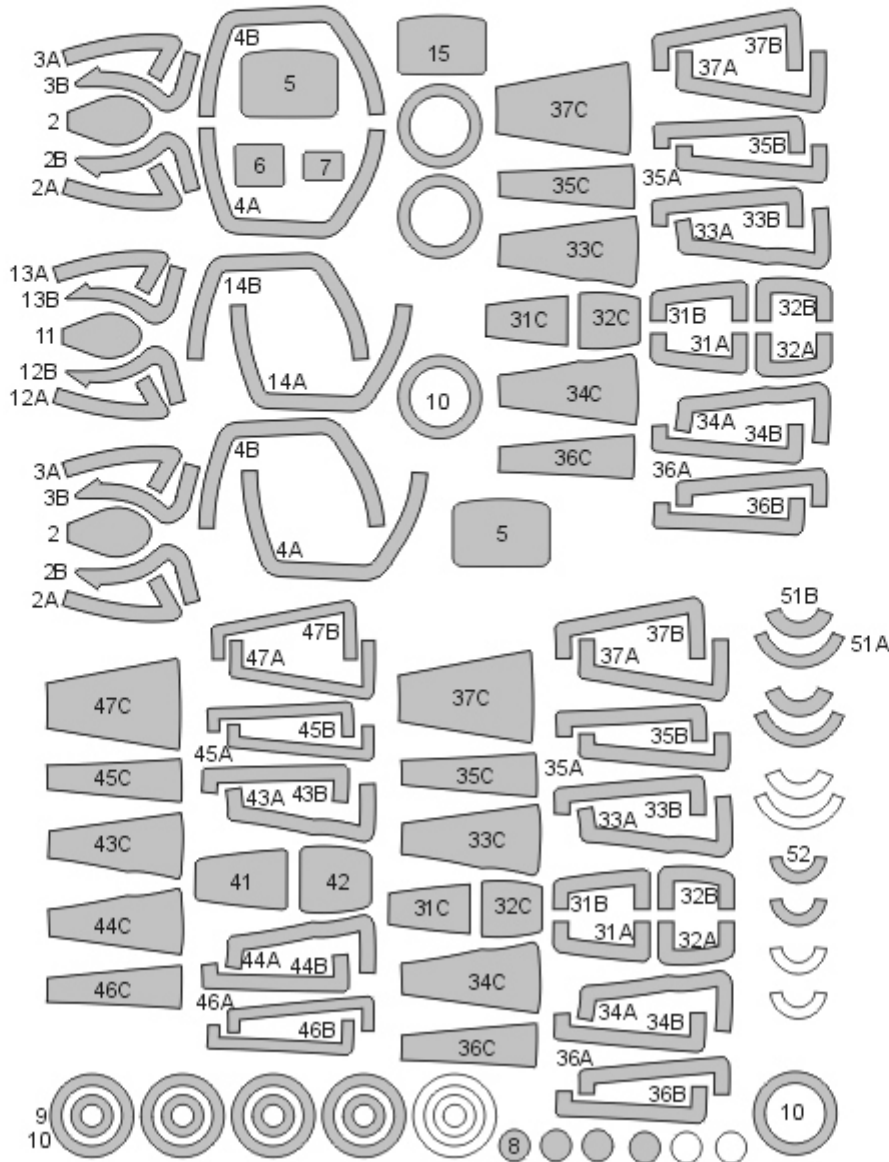

white - spare parts

STEP 1  
mask exterior, paint interior color

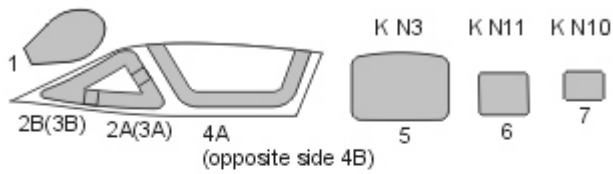

STEP 2  
mask exterior, paint seal color (black)

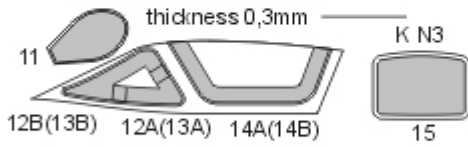

STEP 3  
mask exterior, paint camouflage color

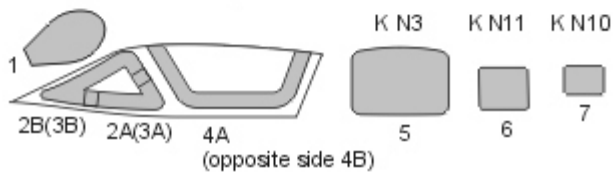

K N4,5,6,7



8

K J13, J14, J15

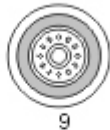

9

K J7



10

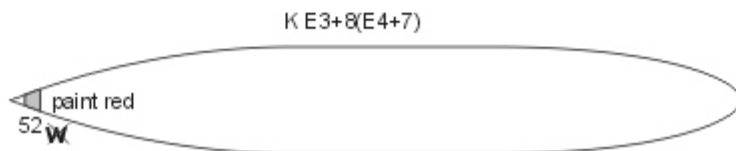

STEP 1  
mask exterior, paint interior color

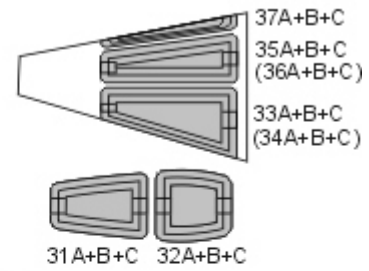

STEP 2  
mask exterior, paint seal color (black)

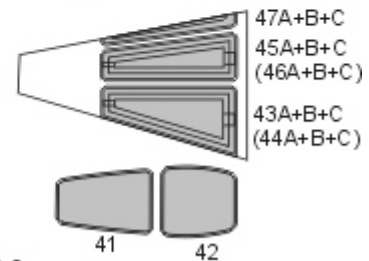

STEP 3  
mask exterior, paint camouflage color

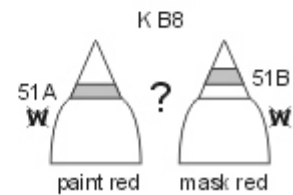
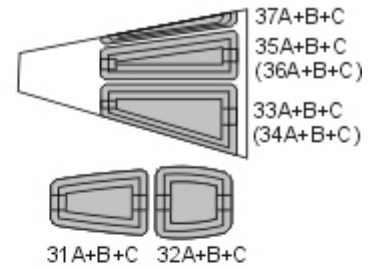



Yak-28PP Brewer-E EXPERT kabuki masks  
for HobbyBoss 81768 kit  
<http://mek.kosmo.cz/newware>

INCLUDES ALSO  
WINDOWS SEAL AND AIRCRAFT  
CANOPY INNER SIDE MASKS

tom.nwkits@seznam.cz

**Important:**

Let the sprayed color dry before applying masks. Remove masks very carefully after painting.  
Where the mask is divided into A and B parts, first apply part A, next part B.  
The set does not include masks for all areas, so mask the rest with masking tape or liquid mask.

K kit part

\* start placing the mask from this point

Placing wet masks on wet surface is recommended, except those marked by **W**

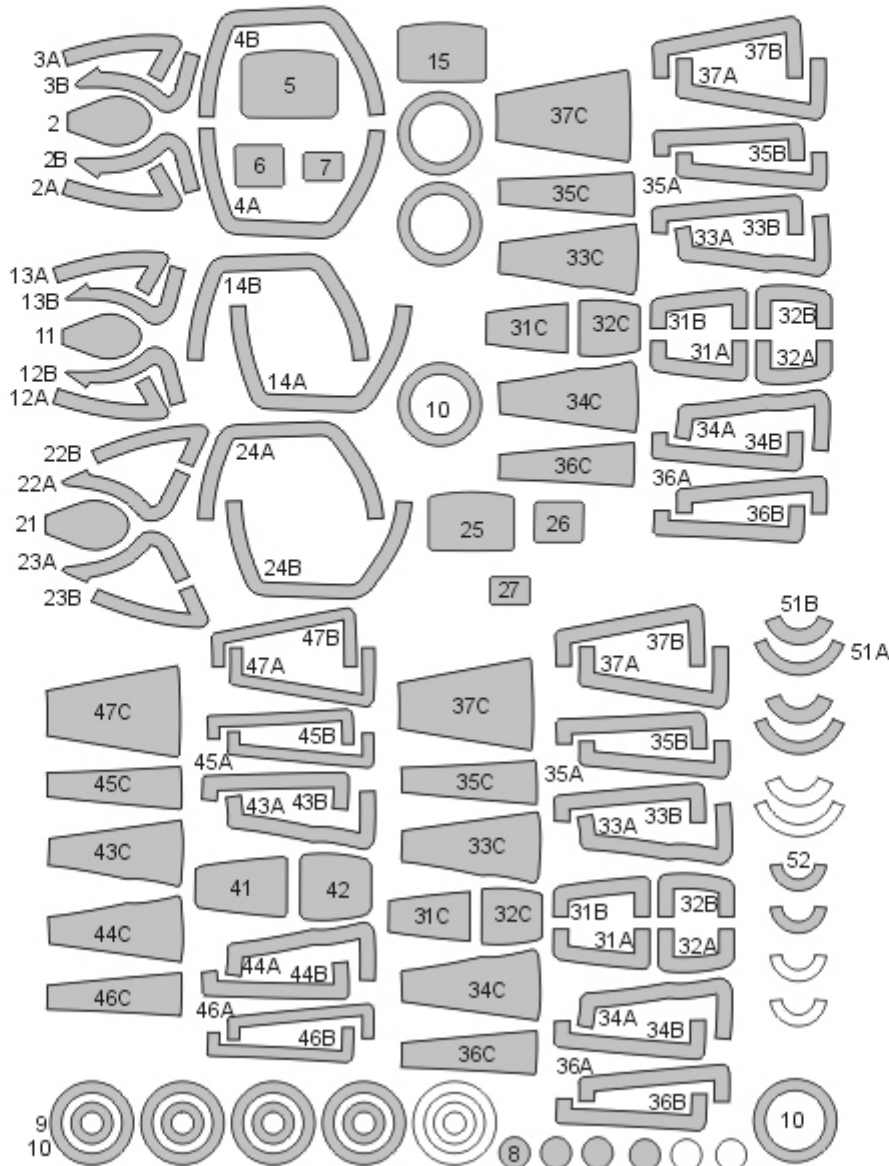

white - spare parts

STEP 1 - exterior view  
mask interior, paint interior color

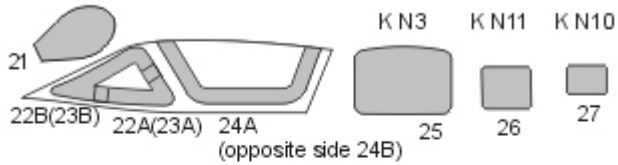

STEP 2  
mask exterior, paint seal color (black)



STEP 3  
mask exterior, paint camouflage color

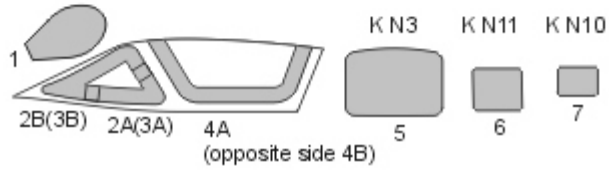

K N4,5,6,7



K J13, J14, J15

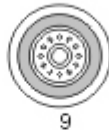

K J7

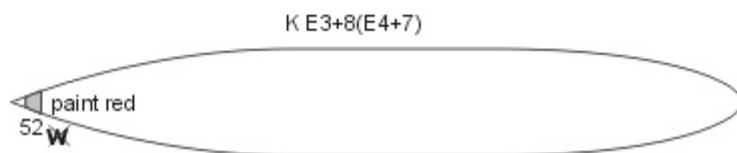

STEP 1  
mask exterior, paint interior color

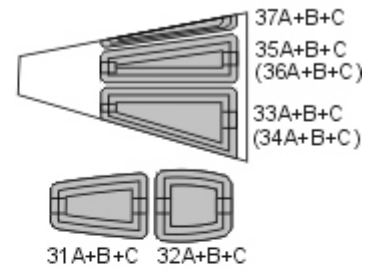

STEP 2  
mask exterior, paint seal color (black)

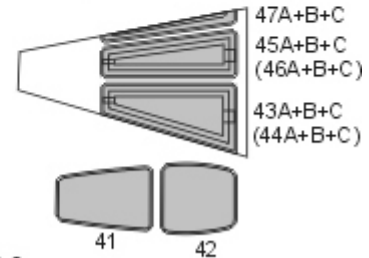

STEP 3  
mask exterior, paint camouflage color

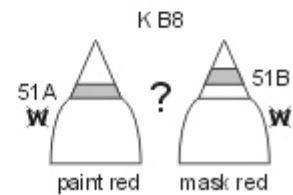
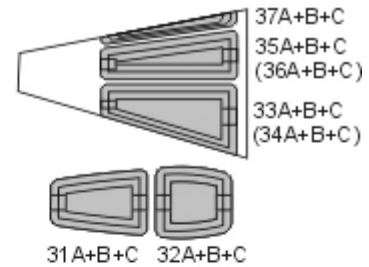



Ju 88P-1 BASIC kabuki masks

for ICM 48228 kit

<http://mek.kosmo.cz/newware>

tom.nwkits@seznam.cz

Use also NWAM1200 Ju-88P-1 NATIONAL INSIGNIA kabuki masks

**Important:**

Let the sprayed color dry before applying masks. Remove masks very carefully after painting.

Where the mask is divided into A and B parts, first apply part A, next part B.

The set does not include masks for all areas, so mask the rest with masking tape or liquid mask.

K kit part

\* start placing the mask from this point

Placing wet masks on wet surface is recommended, except those marked by **W**

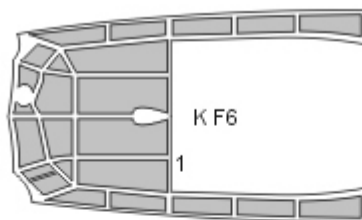
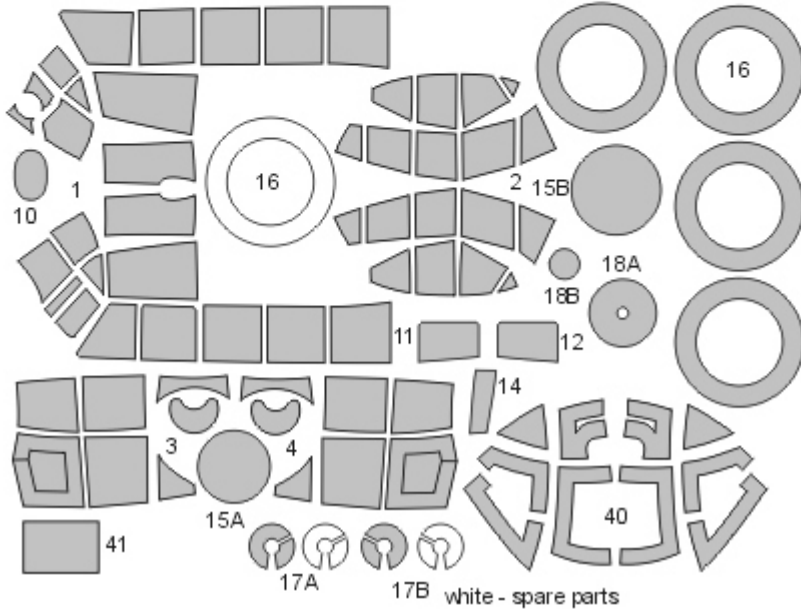

K F 20



10

K F 18



11

K F 19



12

K F 1-2



41

K F 3



14

K F 1



?



15A

15B

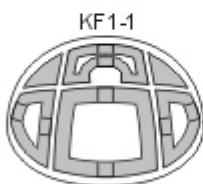

40

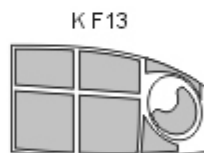

3

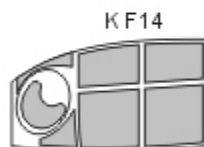

4



2

K C 5+C22

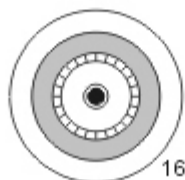

16

K C 4



17A



17B

K C 1-11

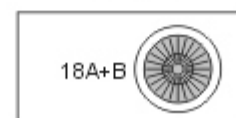

18A+B



Use also NWAM1200 Ju-88P-1 NATIONAL INSIGNIA kabuki masks

**Important:**

Let the sprayed color dry before applying masks. Remove masks very carefully after painting.

Where the mask is divided into A and B parts, first apply part A, next part B.

The set does not include masks for all areas, so mask the rest with masking tape or liquid mask.

K kit part

\* start placing the mask from this point

Placing wet masks on wet surface is recommended, except those marked by **W**

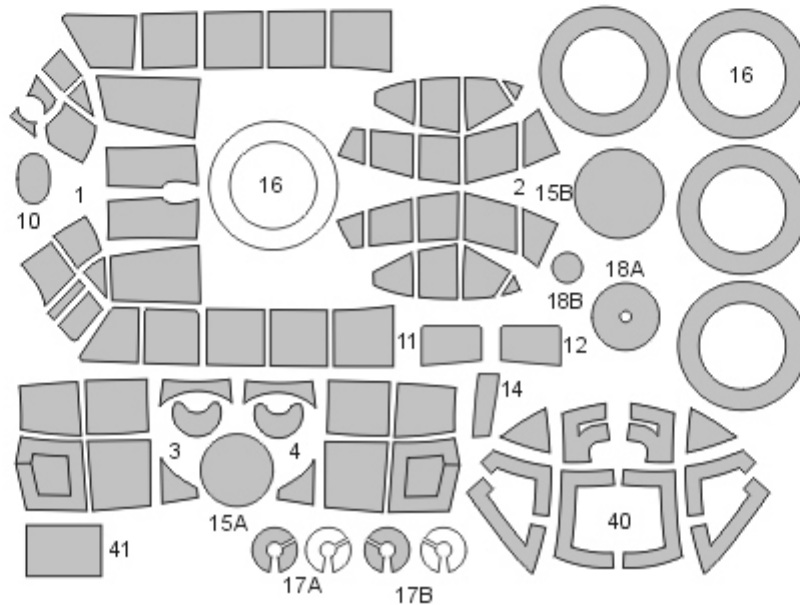
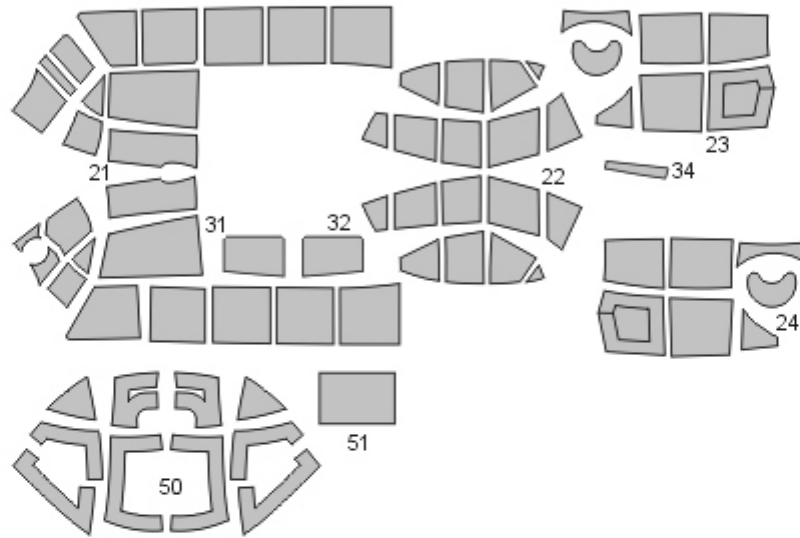

white - spare parts

STEP 1 - exterior view  
mask inner side, paint interior color

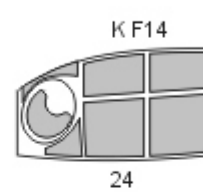
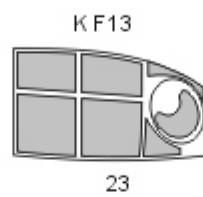
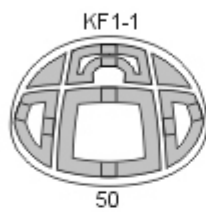
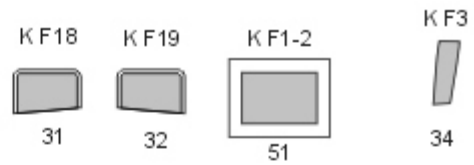
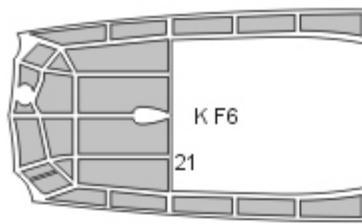

STEP 2  
mask exterior, paint camouflage color

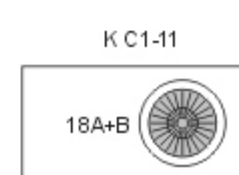
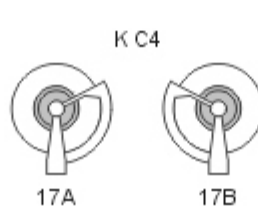
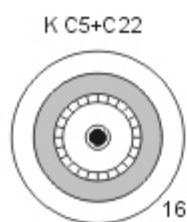
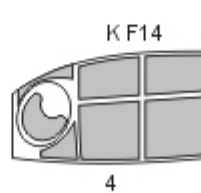
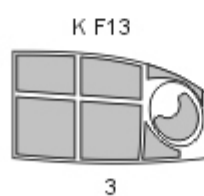
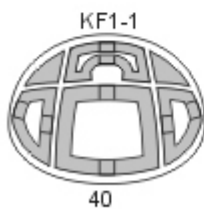
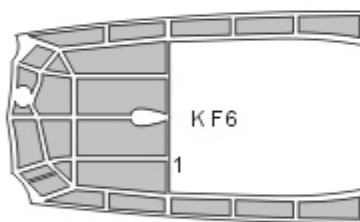

# NWAM1200

1/48 scale



Ju 88P-1 NATIONAL INSIGNIA kabuki masks

for ICM 48228 kits

<http://mek.kosmo.cz/newware>

[tom.nwkits@seznam.cz](mailto:tom.nwkits@seznam.cz)

Use also NWAM1198 or NWAM1199 Ju-88P-1 kabuki masks

**Important:**

Let the sprayed color dry before applying masks. Remove masks very carefully after painting.

Where the mask is divided into A and B parts, first apply part A, next part B.

The set does not include masks for all areas, so mask the rest with masking tape or liquid mask.

K kit part

\* start placing the mask from this point

Placing wet masks on wet surface is recommended, except those marked by **W**

35W

35B

39W

39B

40B

37W

37B

40W

Place mask nnW  
paint white  
place mask nnB  
paint black

1. Apply mask 37W
2. Paint white
3. Apply mask 37B
4. Paint black

37W

37B

masks numbers are corresponding to decals numbers





MiG-29 ADVANCED kabuki masks

for Academy, Hobby2000, Kora and other based on 2116 kit

<http://mek.kosmo.cz/newware>

tom.nwkits@seznam.cz

**Important:**

Let the sprayed color dry before applying masks. Remove masks very carefully after painting.  
Where the mask is divided into A and B parts, first apply part A, next part B.  
The set does not include masks for all areas, so mask the rest with masking tape or liquid mask.

K kit part

\* start placing the mask from this point

Placing wet masks on wet surface is recommended, except those marked by **W**

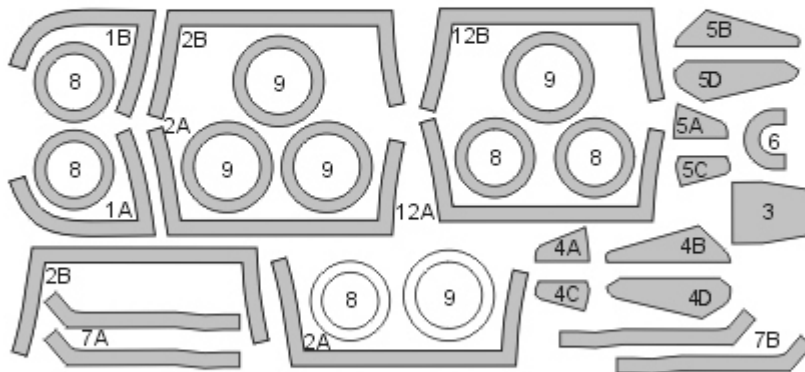

white - spare parts

STEP 1  
mask exterior, paint interior color

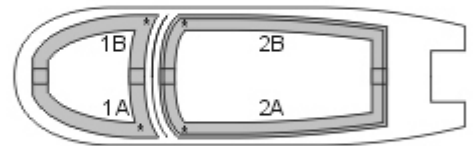

STEP 2  
mask exterior, paint seal color

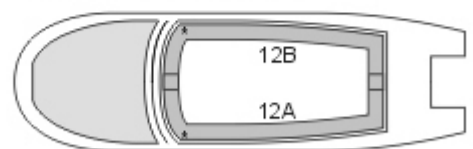

STEP 3  
mask exterior, paint camouflage color

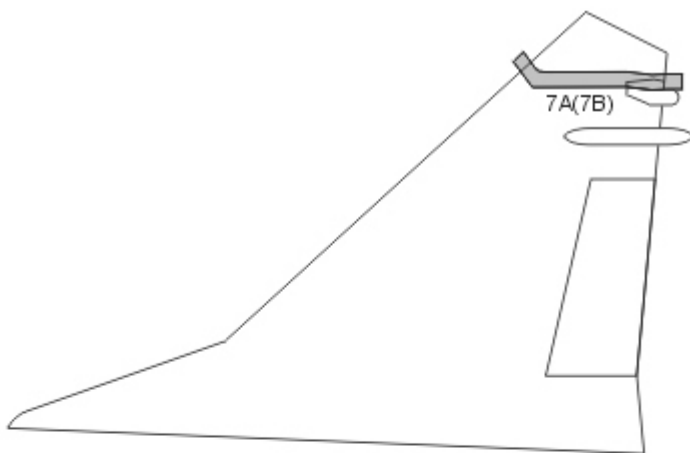
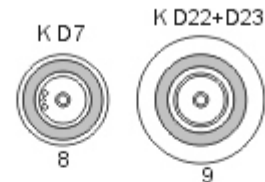
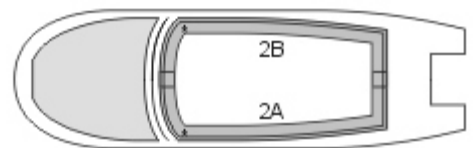

Apply masks 5A and 5B on upper side first,  
next apply masks 5C and 5D on bottom side

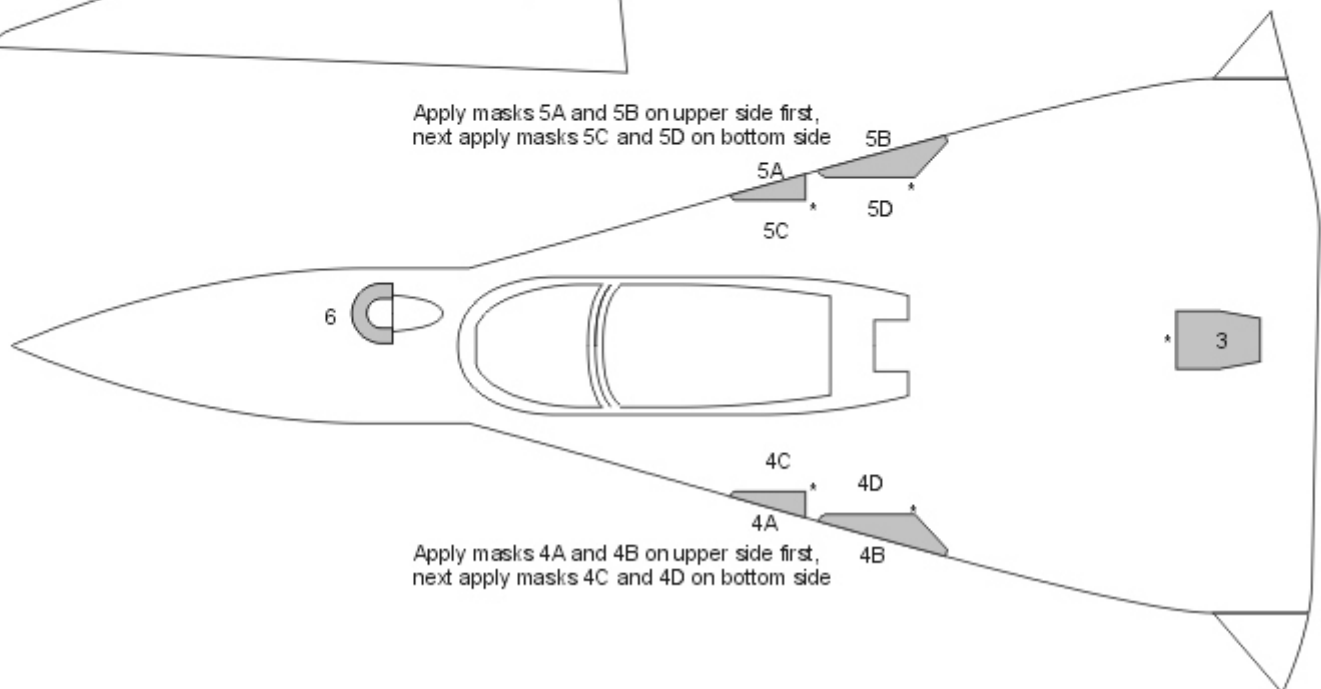
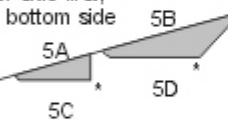

Apply masks 4A and 4B on upper side first,  
next apply masks 4C and 4D on bottom side



## MiG-29 EXPERT kabuki masks

for Academy, Hobby2000, Kora and other based on 2116 kit

<http://mek.kosmo.cz/newware>

INCLUDES AIRCRAFT CANOPY  
INNER SIDE MASKS

tom.nwkits@seznam.cz

### Important:

Let the sprayed color dry before applying masks. Remove masks very carefully after painting.

Where the mask is divided into A and B parts, first apply part A, next part B.

The set does not include masks for all areas, so mask the rest with masking tape or liquid mask.

K kit part

\* start placing the mask from this point

Placing wet masks on wet surface is recommended, except those marked by **W**

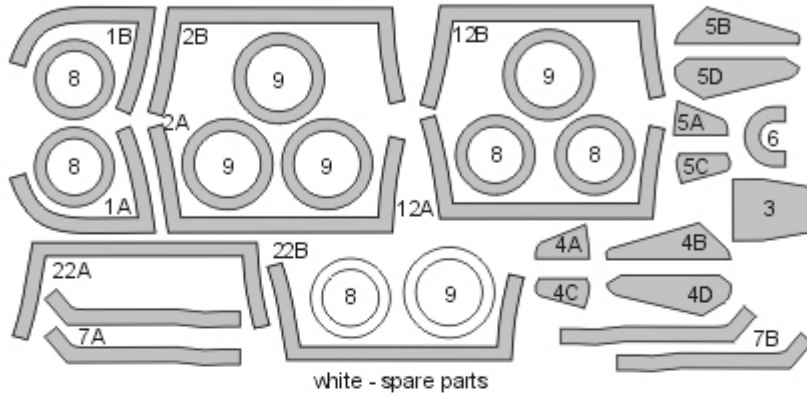

STEP 1 - exterior view  
mask interior, paint interior color

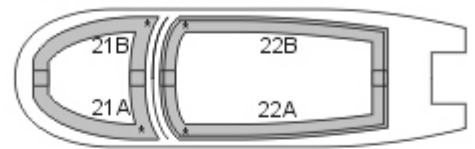

STEP 2  
mask exterior, paint seal color

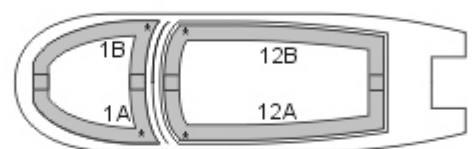

STEP 3  
mask exterior, paint camouflage color

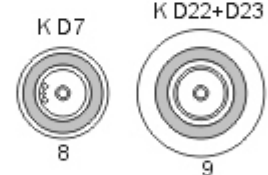
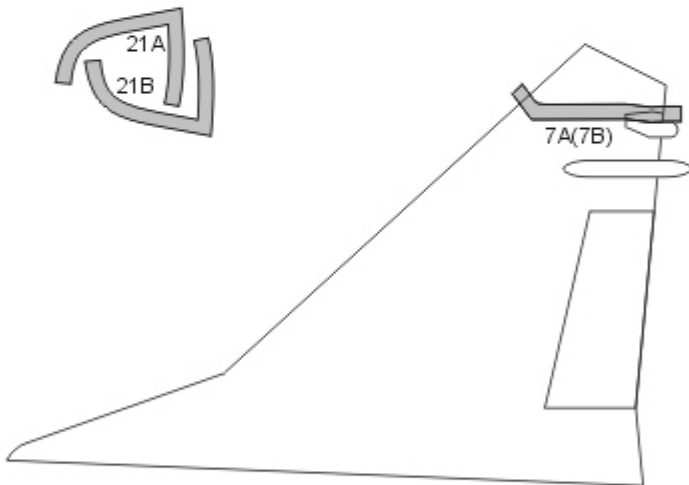
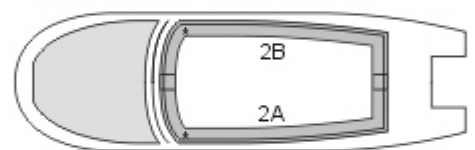

Apply masks 5A and 5B on upper side first,  
next apply masks 5C and 5D on bottom side

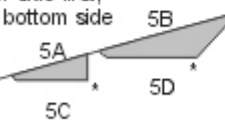

Apply masks 4A and 4B on upper side first,  
next apply masks 4C and 4D on bottom side

