



NEW WARE NEWSLETTER

NEW MASKS FEBRUARY 2024

NWAM1169 1/48 Mi-4AV Hound BASIC kabuki masks	Trumpeter
NWAM1170 1/48 Mi-4AV Hound EXPERT kabuki masks	Trumpeter
NWAM1171 1/48 Yak-9D BASIC kabuki masks	Zvezda
NWAM1172 1/48 Yak-9D EXPERT kabuki masks	Zvezda
NWAM1173 1/72 A-6A Int ruder BASIC kabuki masks	Trumpeter
NWAM1174 1/72 A-6A Int ruder ADVANCED kabuki masks	Trumpeter
NWAM1175 1/72 A-6A Int ruder EXPERT kabuki masks	Trumpeter
NWAM1176 1/48 Mi G-29K BASIC kabuki masks	HobbyBoss
NWAM1177 1/48 Mi G-29K ADVANCED kabuki masks	HobbyBoss
NWAM1178 1/48 Mi G-29K EXPERT kabuki masks	HobbyBoss
NWAM1179 1/48 A-10C BASIC kabuki masks	Hobby 2000
NWAM1180 1/48 A-10C EXPERT kabuki masks	Hobby 2000



Mi-4AV Hound BASIC kabuki masks

for Trumpeter 05818 kit

<http://mek.kosmo.cz/newware>

tom.nwkits@seznam.cz

Important:

Let the sprayed color dry before applying masks. Remove masks very carefully after painting.
Where the mask is divided into A and B parts, first apply part A, next part B.
The set does not include masks for all areas, so mask the rest with masking tape or liquid mask.

K kit part

^ start placing the mask from this point

Placing wet masks on wet surface is recommended, except those marked by **W**

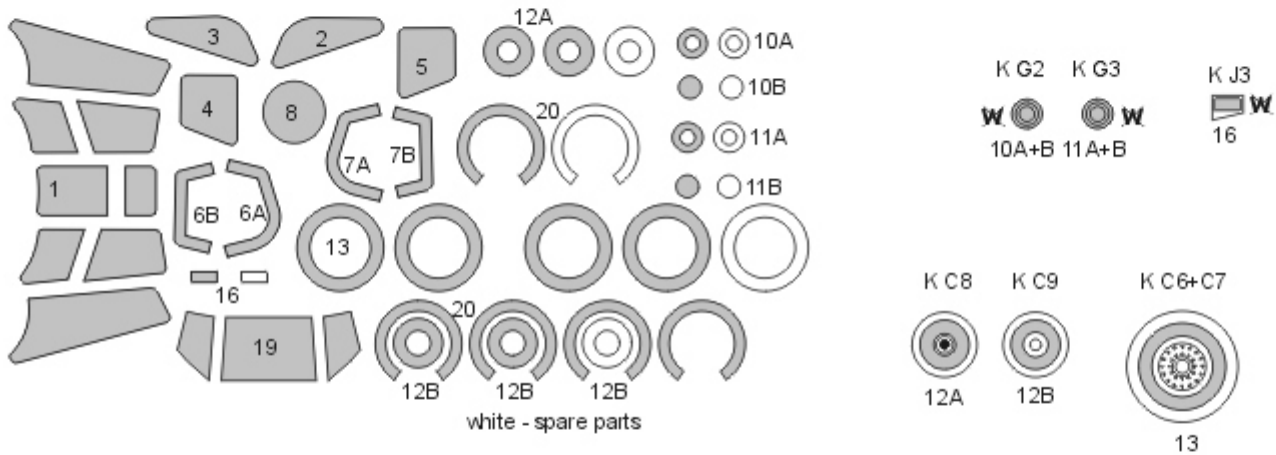

white - spare parts

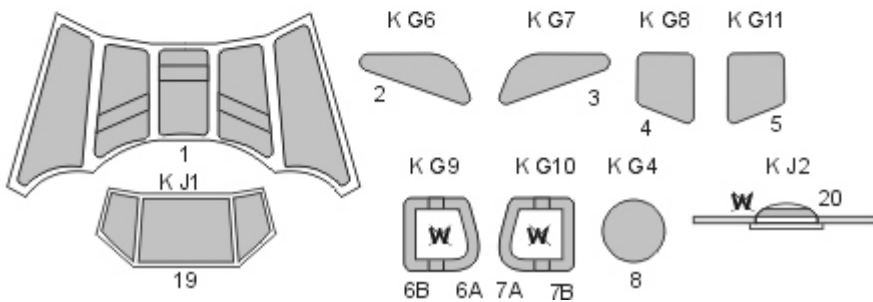



NWAM1170

Mi-4AV Hound EXPERT kabuki masks
for Trumpeter 05818 kit
<http://mek.kosmo.cz/newware>

INCLUDES ALSO
WINDOWS INNER SIDE
AND CAMOUFLAGE DETAILS MASKS

1/48 scale

tom.nwkits@seznam.cz

Important:

Let the sprayed color dry before applying masks. Remove masks very carefully after painting.
Where the mask is divided into A and B parts, first apply part A, next part B.
The set does not include masks for all areas, so mask the rest with masking tape or liquid mask.

K kit part

* start placing the mask from this point

Placing wet masks on wet surface is recommended, except those marked by **W**

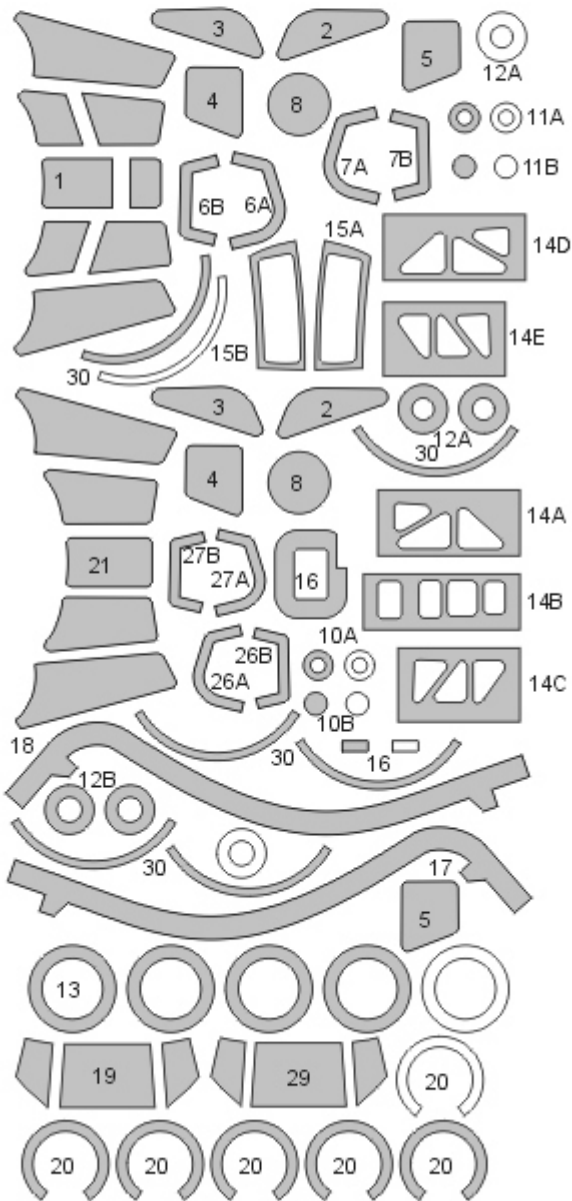

white - spare parts

STEP 1 - exterior view
mask interior, paint interior color

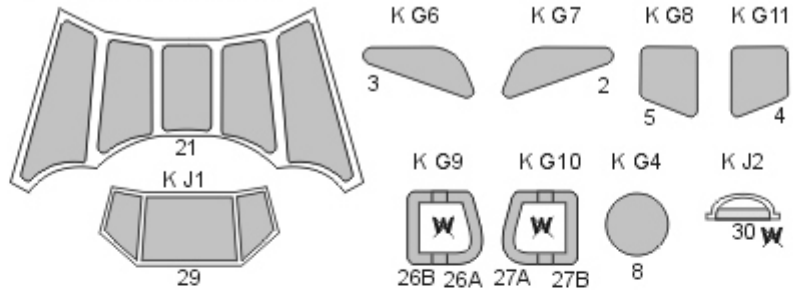

STEP 2
mask exterior, paint camouflage color

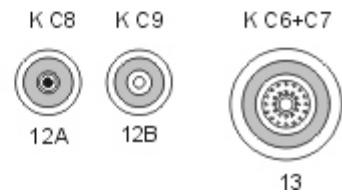
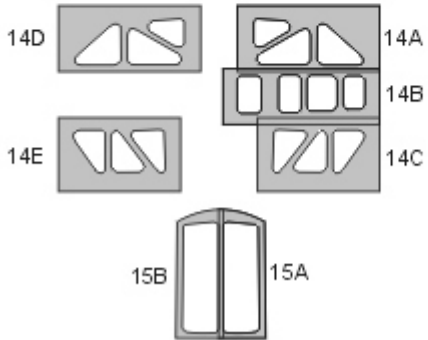
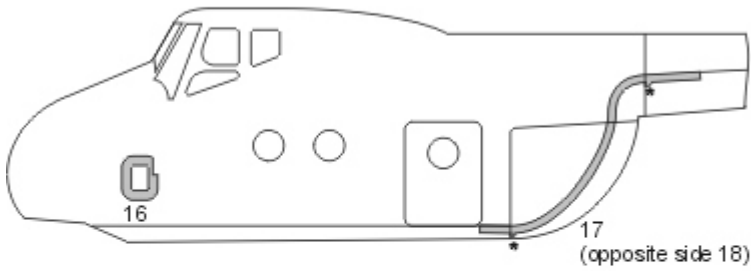
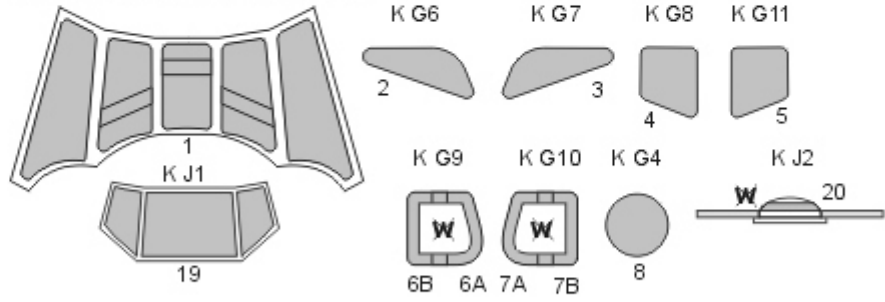



Yak-9D BASIC kabuki masks

for Zvezda 4815 kit

<http://mek.kosmo.cz/newware>

tom.nwkits@seznam.cz

Important:

Let the sprayed color dry before applying masks. Remove masks very carefully after painting.

Where the mask is divided into A and B parts, first apply part A, next part B.

The set does not include masks for all areas, so mask the rest with masking tape or liquid mask.

K kit part

* start placing the mask from this point

Placing wet masks on wet surface is recommended, except those marked by **W**

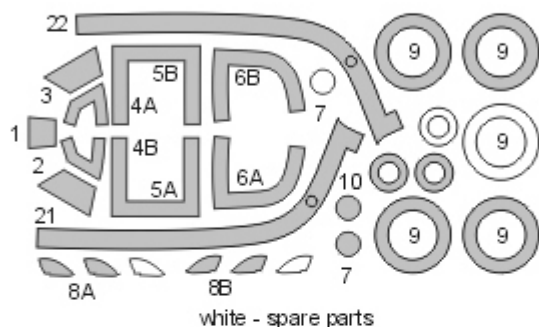

white - spare parts

K B10+24+17+20, B10+24+17+21 K B18



9



10

K D8

K D2, D3



7



8A+8B

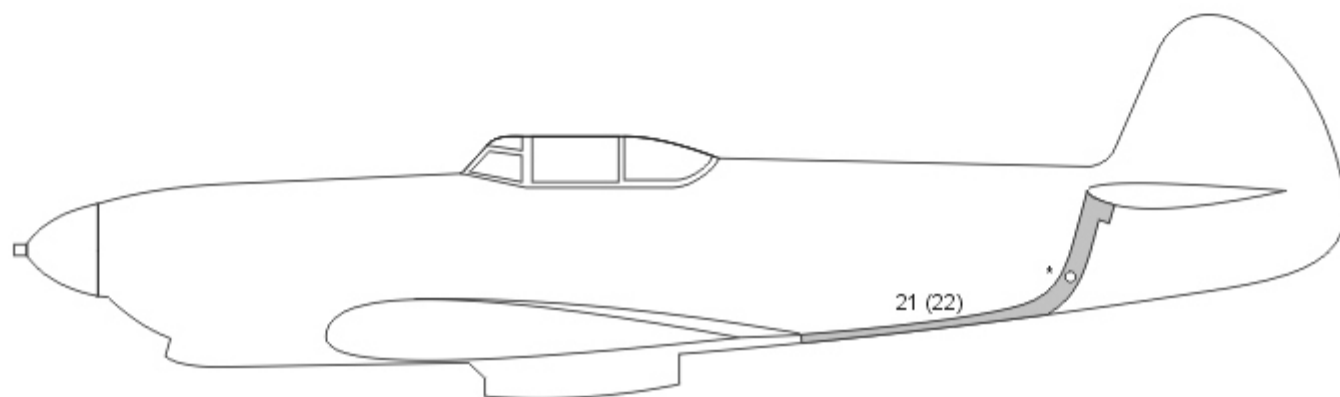
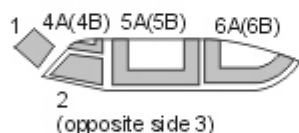



Yak-9D EXPERT kabuki masks

for Zvezda 4815 kit

<http://mek.kosmo.cz/newware>

INCLUDES ALSO
WINDOWS INNER SIDE MASKS

tom.nwkits@seznam.cz

Important:

Let the sprayed color dry before applying masks. Remove masks very carefully after painting.
Where the mask is divided into A and B parts, first apply part A, next part B.
The set does not include masks for all areas, so mask the rest with masking tape or liquid mask.

K kit part

* start placing the mask from this point

Placing wet masks on wet surface is recommended, except those marked by **W**

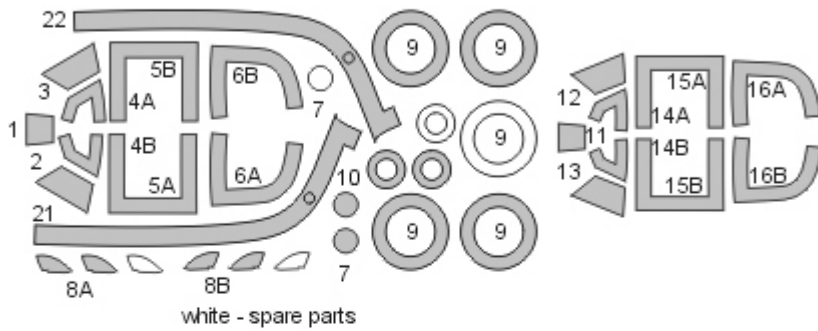

K B10+24+17+20, B10+24+17+21 K B18



K D8 K D2, D3



STEP 1 - exterior view
mask interior, paint interior color

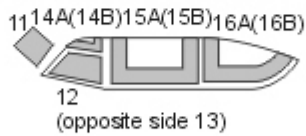

STEP 2
mask exterior, paint camouflage color

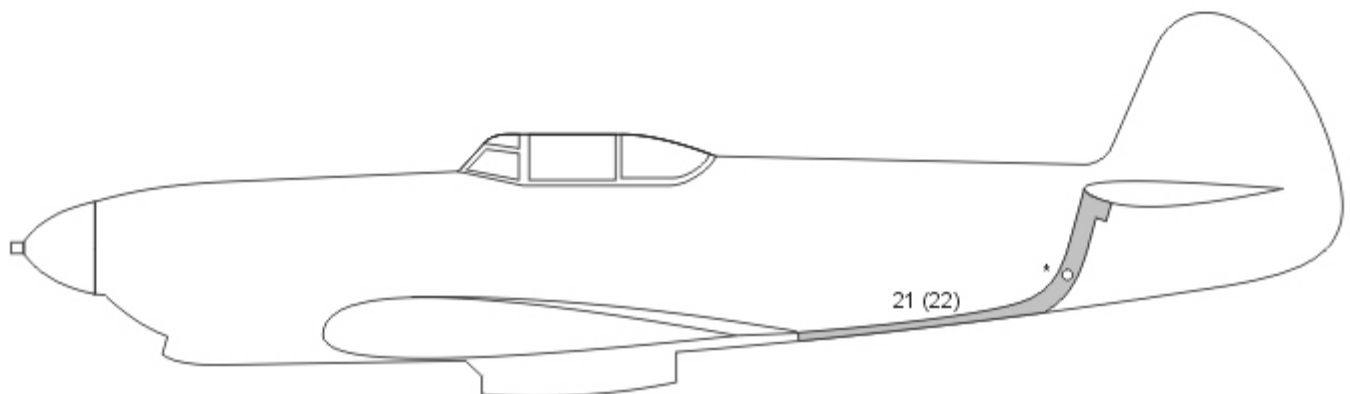
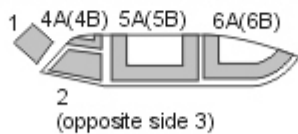



A-6A Intruder BASIC kabuki masks
for Trumpeter 01640 kit
<http://mek.kosmo.cz/newware>

tom.nwkits@seznam.cz

Important:

Let the sprayed color dry before applying masks. Remove masks very carefully after painting.
Where the mask is divided into A and B parts, first apply part A, next part B.
The set does not include masks for all areas, so mask the rest with masking tape or liquid mask.

K kit part

* start placing the mask from this point

Placing wet masks on wet surface is recommended, except those marked by **W**

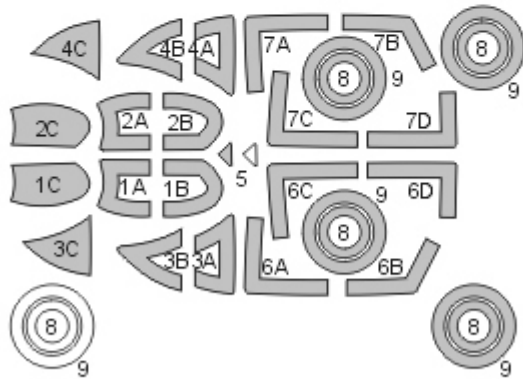

white - spare parts

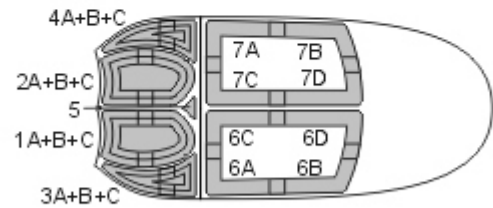

K G22 K G11

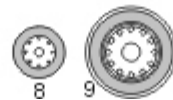

NWAM1174



A-6A Intruder **ADVANCED** kabuki masks
for Trumpeter 01640 kit

http://mek.kosmo.cz/new_ware

INCLUDES ALSO
WINDOWS SEAL, BOMBS YELLOW
STRIPES AND CAMOUFLAGE DETAILS
MASKS

1/72 scale

tom.nwkits@seznam.cz

Important:

Let the sprayed color dry before applying masks. Remove masks very carefully after painting.

Where the mask is divided into A and B parts, first apply part A, next part B.

The set does not include masks for all areas, so mask the rest with masking tape or liquid mask.

K kit part

* start placing the mask from this point

Placing wet masks on wet surface is recommended, except those marked by **W**

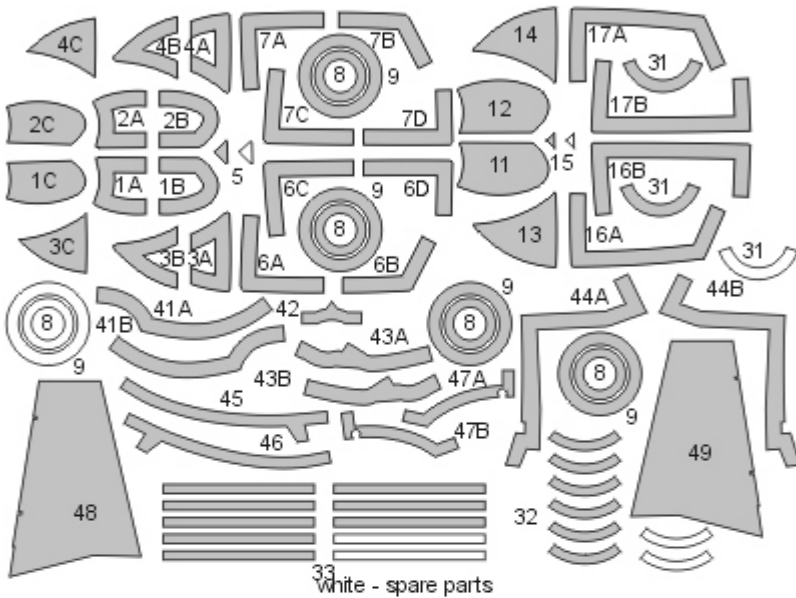

STEP 1

mask exterior, paint interior color

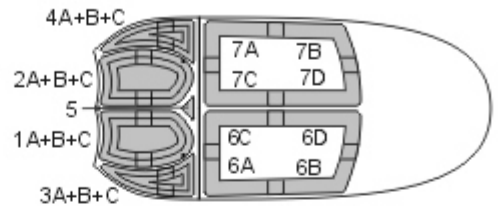

STEP 2

mask exterior, paint seal color

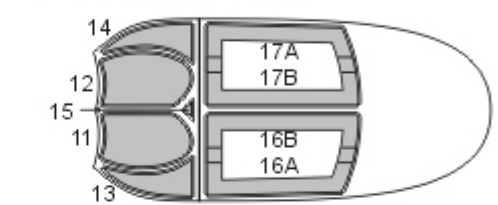

STEP 3
mask exterior, paint camouflage color

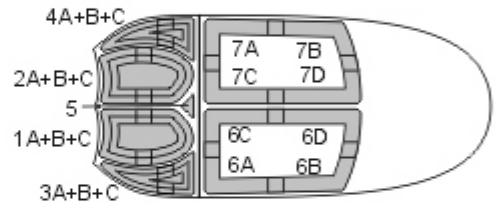

thickness of seal 0,3 mm

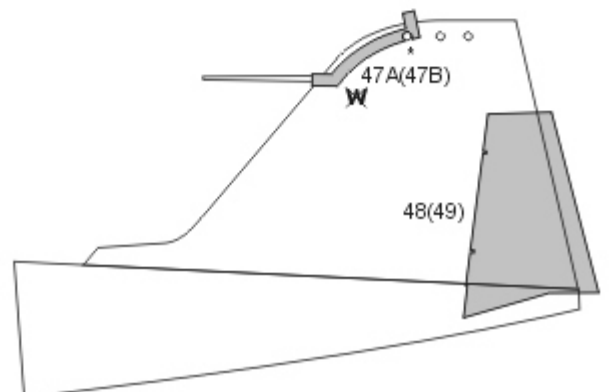
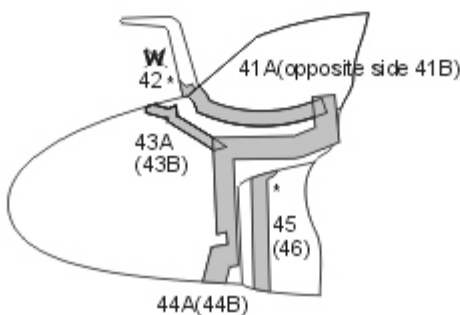
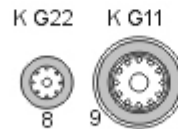
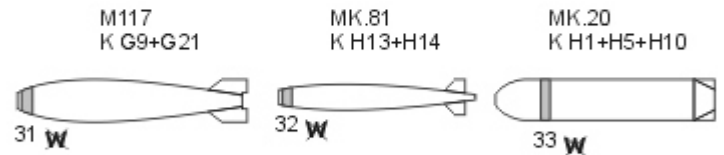
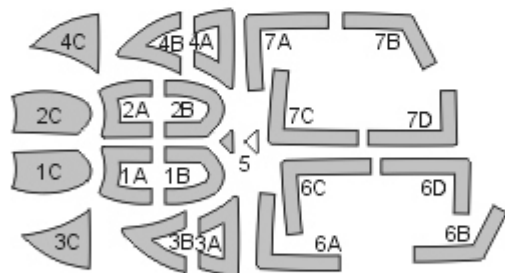



NWAM1175

A-6A Intruder EXPERT kabuki masks for Trumpeter 01640 kit

http://mek.kosmo.cz/new_ware

INCLUDES ALSO
WINDOWS SEAL AND INNER SIDE
MASKS BOMBS YELLOW STRIPES
AND CAMOUFLAGE DETAILS MASKS

1/72 scale

tom.nwkits@seznam.cz

Important:

Let the sprayed color dry before applying masks. Remove masks very carefully after painting.
Where the mask is divided into A and B parts, first apply part A, next part B.
The set does not include masks for all areas, so mask the rest with masking tape or liquid mask.

K kit part

* start placing the mask from this point

Placing wet masks on wet surface is recommended, except those marked by **W**

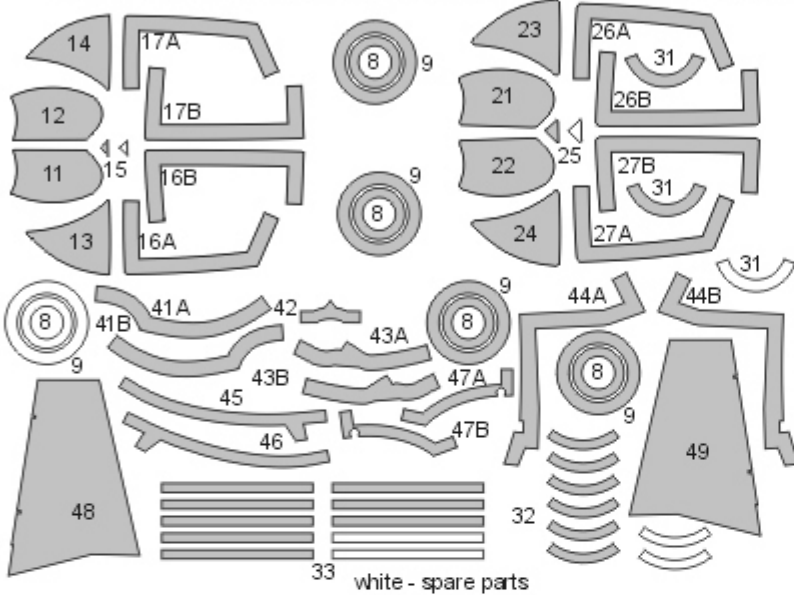

STEP 1 - exterior view

mask interior, paint interior color

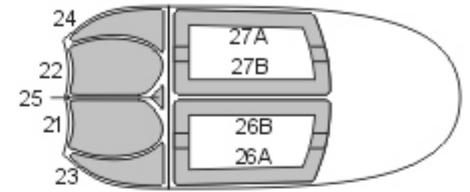

STEP 2

mask exterior, paint seal color

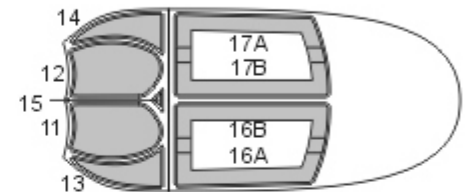

STEP 3

mask exterior, paint camouflage color

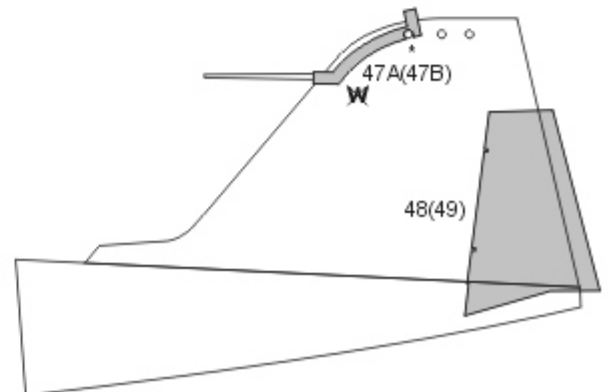
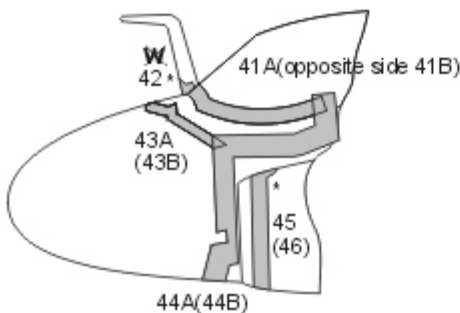
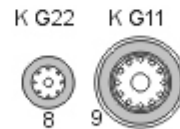
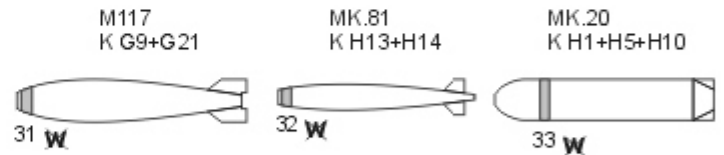
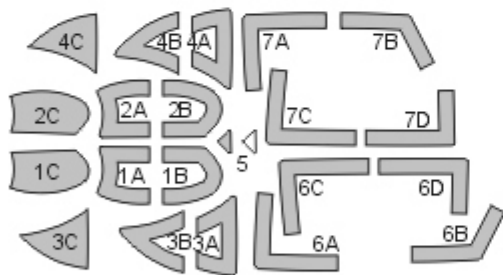
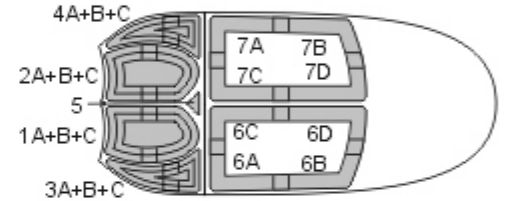



MiG-29K BASIC kabuki masks

for HobbyBoss 81786 kit

<http://mek.kosmo.cz/newware>

tom.nwkits@seznam.cz

Important:

Let the sprayed color dry before applying masks. Remove masks very carefully after painting.

Where the mask is divided into A and B parts, first apply part A, next part B.

The set does not include masks for all areas, so mask the rest with masking tape or liquid mask.

K kit part

^ start placing the mask from this point

Placing wet masks on wet surface is recommended, except those marked by **W**

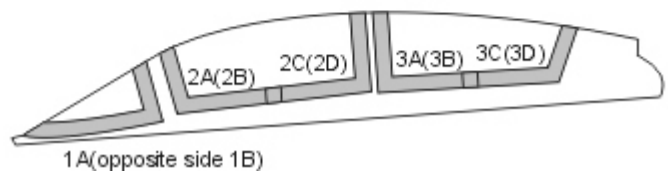
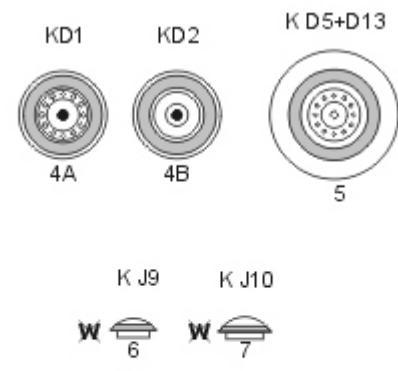
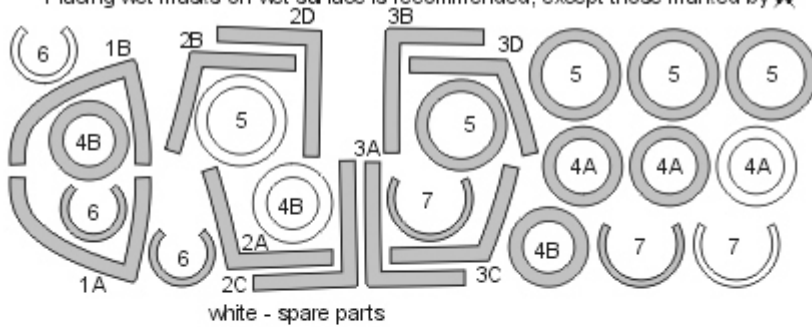

NWAM1177



MiG-29K ADVANCED kabuki masks
for HobbyBoss 81786 kit
<http://mek.kosmo.cz/newware>

INCLUDES ALSO
WINDOWS SEAL
AND CAMOUFLAGE DETAILS MASKS

1/48 scale

tom.nwkits@seznam.cz

Important:

Let the sprayed color dry before applying masks. Remove masks very carefully after painting.
Where the mask is divided into A and B parts, first apply part A, next part B.
The set does not include masks for all areas, so mask the rest with masking tape or liquid mask.

K kit part

* start placing the mask from this point

Placing wet masks on wet surface is recommended, except those marked by **W**

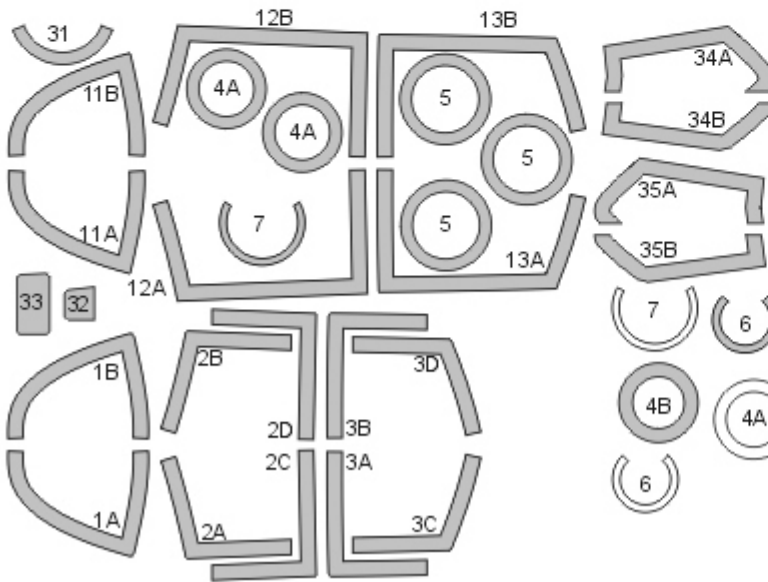

STEP 1
paint interior color

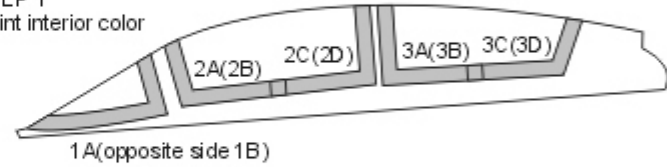

STEP 2
paint seal color

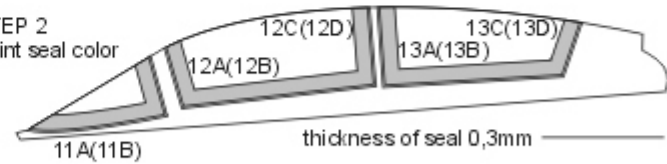

STEP 3
paint camouflage color

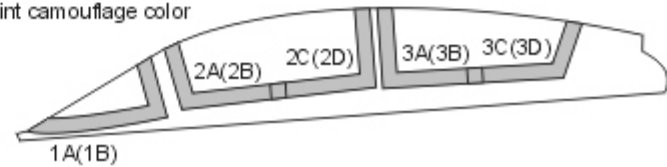

white - spare parts

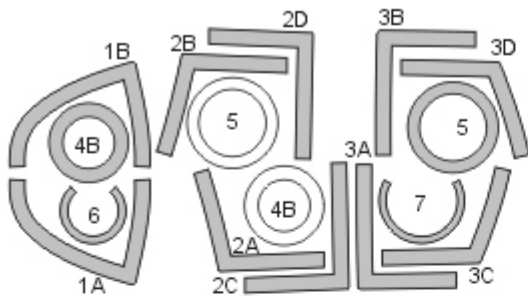

K J9 K J10



KD1

KD2

K D5+D13

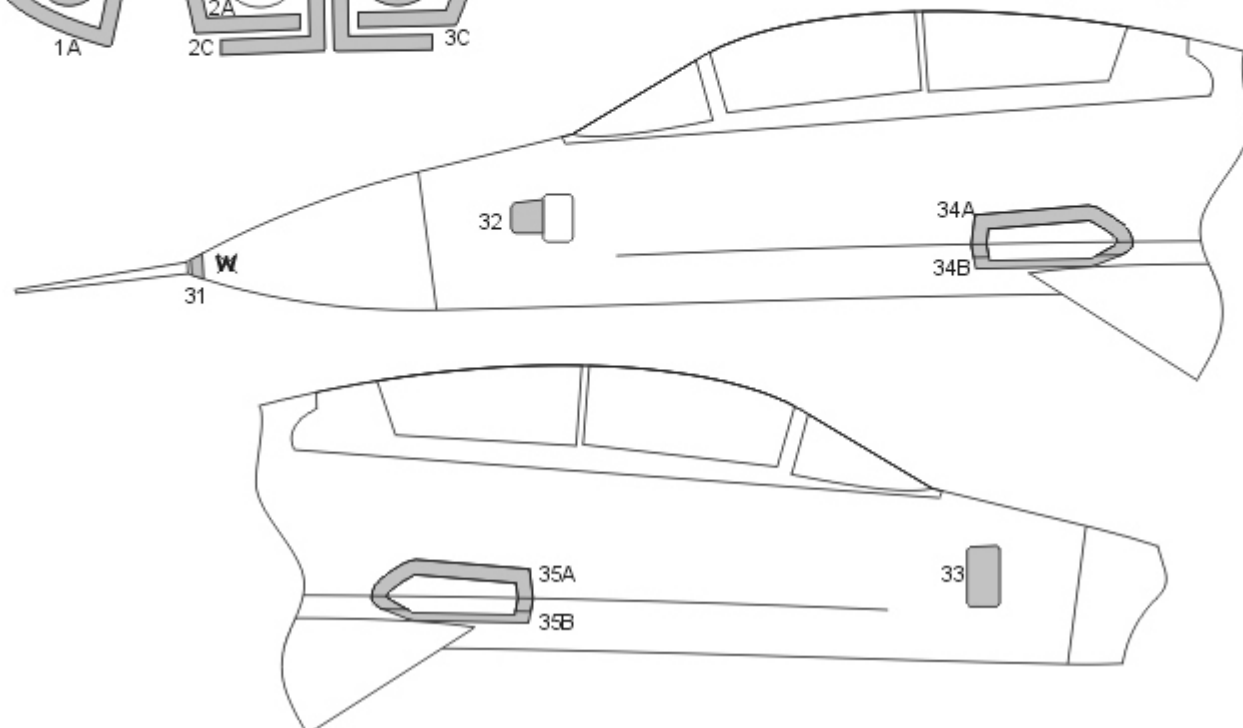
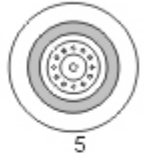



NWAM1178

MiG-29K EXPERT kabuki masks

for HobbyBoss 81786 kit

http://mek.kosmo.cz/new_ware

INCLUDES ALSO
WINDOWS SEAL AND INNER SIDE MASKS
AND CAMOUFLAGE DETAILS MASKS

1/48 scale

tom.nwkits@seznam.cz

Important:

Let the sprayed color dry before applying masks. Remove masks very carefully after painting.
Where the mask is divided into A and B parts, first apply part A, next part B.
The set does not include masks for all areas, so mask the rest with masking tape or liquid mask.

K kit part

* start placing the mask from this point

Placing wet masks on wet surface is recommended, except those marked by **W**

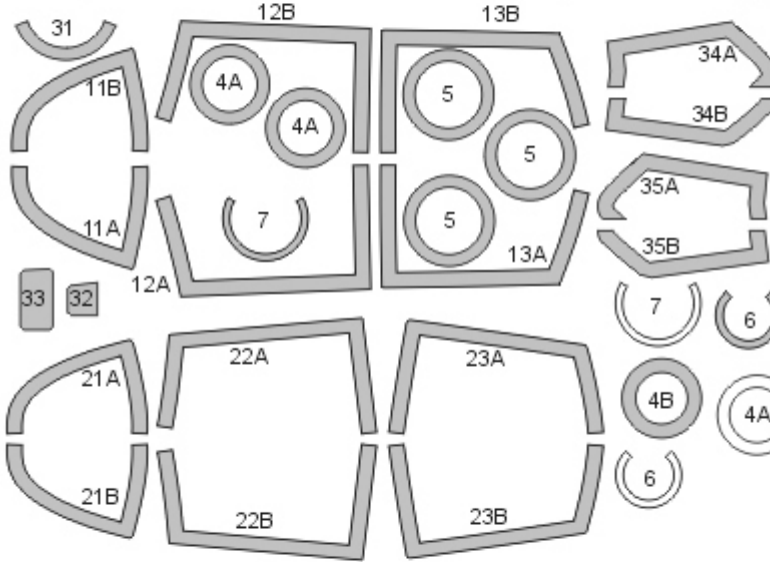

STEP 1 - exterior view
mask interior, paint interior color



STEP 2
mask exterior, paint seal color

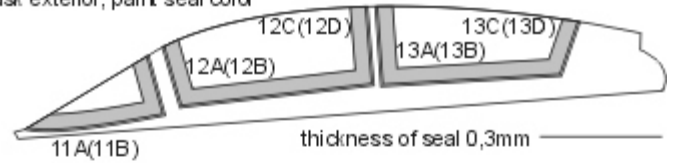

STEP 3
mask exterior, paint camouflage color



white - spare parts

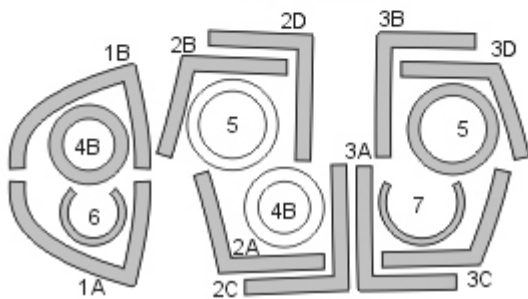

K J9 K J10



KD1

KD2

K D5+D13

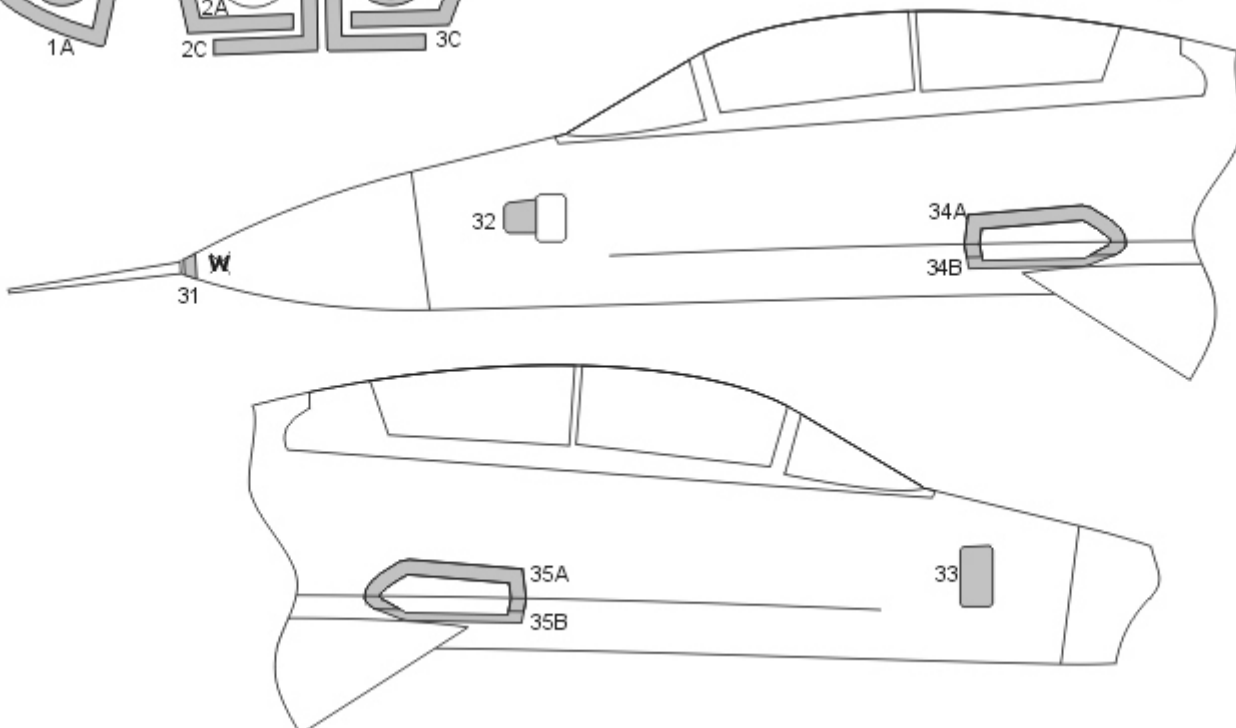
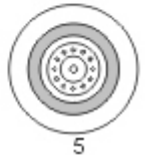



A-10C BASIC kabuki masks

for Hobby 2000 48029, 48030 and other kits

<http://mek.kosmo.cz/newware>

tom.nwkits@seznam.cz

Important:

Let the sprayed color dry before applying masks. Remove masks very carefully after painting.

Where the mask is divided into A and B parts, first apply part A, next part B.

The set does not include masks for all areas, so mask the rest with masking tape or liquid mask.

K kit part

* start placing the mask from this point

Placing wet masks on wet surface is recommended, except those marked by **W**

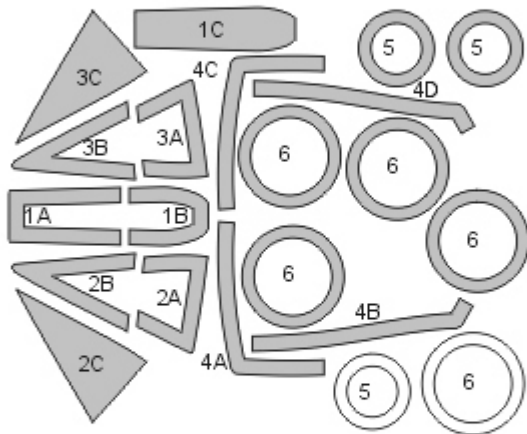

white - spare parts

K A50+A51

K D37+A52

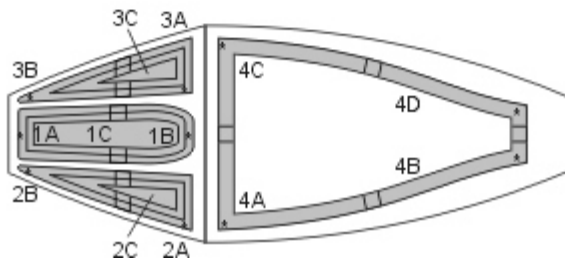
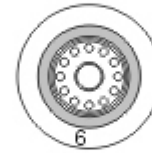

NWAM1180



A-10C EXPERT kabuki masks

for Hobby 2000 48029, 48030 and other kits

<http://mek.kosmo.cz/newware>

INCLUDES ALSO WINDOWS
INNER SIDE AND CAMOUFLAGE
DETAILS MASKS

1/48 scale

tom.nwkits@seznam.cz

Important:

Let the sprayed color dry before applying masks. Remove masks very carefully after painting.

Where the mask is divided into A and B parts, first apply part A, next part B.

The set does not include masks for all areas, so mask the rest with masking tape or liquid mask.

K kit part

* start placing the mask from this point

Placing wet masks on wet surface is recommended, except those marked by **W**

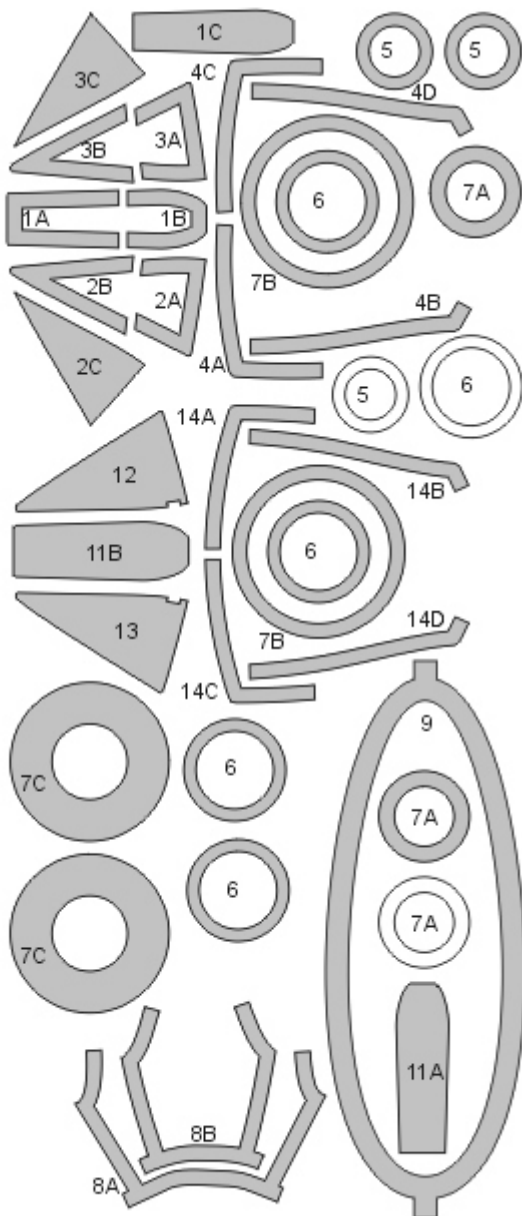

white - spare parts

STEP 1 - exterior view
mask interior

paint frame color (yellow or red)

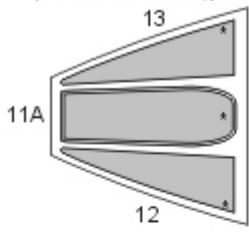

paint interior color

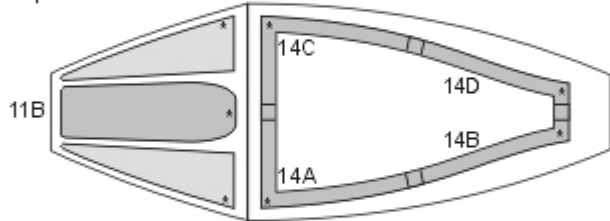

STEP 2
mask exterior, paint camouflage color

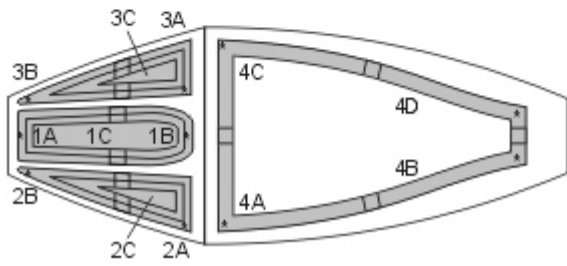

K A50+A51



K D37+A52

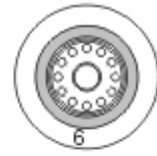

K D38

