



NEW WARE NEWSLETTER

NEW MASKS DECEMBER 2023

NWAM1159 1/48 Westland Sea King HAS.1/ HAS5/ HU.5 ADVANCED kabuki masks	Airfix
NWAM1160 1/48 Westland Sea King HAS.1/ HAS5/ HU.5 EXPERT kabuki masks	Airfix
NWAM1161 1/48 P-47D-25RE Thunderbolt BASIC kabuki masks	MiniArt
NWAM1162 1/48 P-47D-25RE Thunderbolt EXPERT kabuki masks	MiniArt
NWAM1163 1/48 F-35B Lightning II BASIC kabuki masks	Tamiya
NWAM1164 1/48 F-35B Lightning II EXPERT kabuki masks	Tamiya
NWAM1165 1/48 F-35B Lightning II CAMOUFLAGE kabuki masks	Tamiya



Westland Sea King HAS.1/HAS.5/HU.5 ADVANCED kabuki masks

for Airfix A11006 kit

<http://mek.kosmo.cz/newware>

tom.nwkits@seznam.cz

Important:

Let the sprayed color dry before applying masks. Remove masks very carefully after painting.
Where the mask is divided into A and B parts, first apply part A, next part B.
The set does not include masks for all areas, so mask the rest with masking tape or liquid mask.

K kit part

* start placing the mask from this point

Placing wet masks on wet surface is recommended, except those marked by **W**

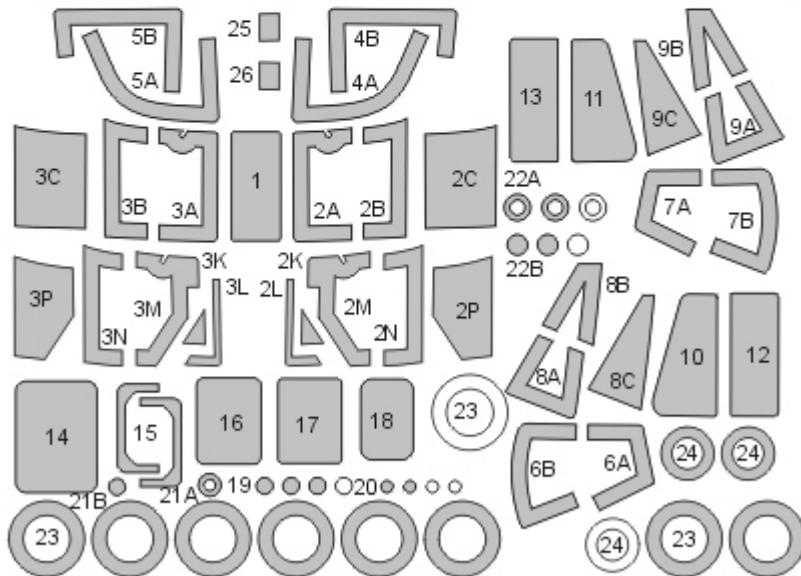

WHITE - SPARE MASKS

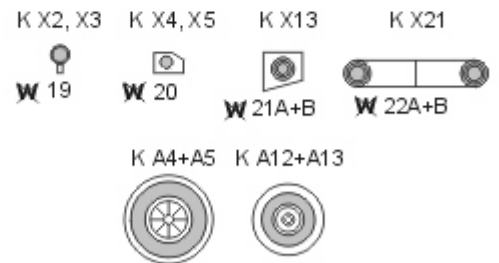
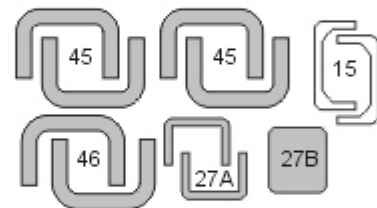

STEP 1 paint camouflage color

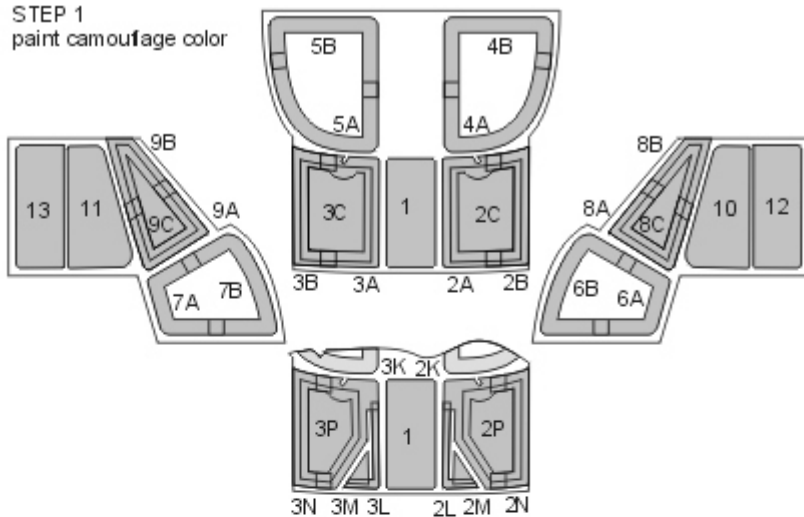

STEP 2 paint seal color (black)

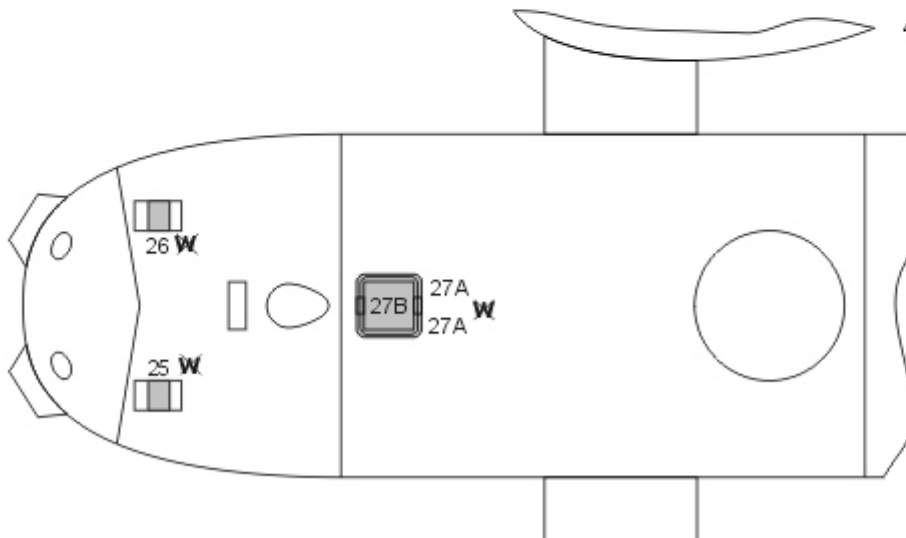
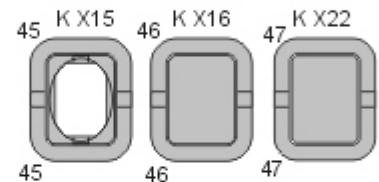

NWAM1160

1/48 scale



Westland Sea King HAS.1/HAS.5/HU.5 EXPERT kabuki masks

for Airfix A 11006 kit

<http://mek.kosmo.cz/newware>

INCLUDES ALSO WINDOWS
INNER SIDE MASKS

tom.nwkits@seznam.cz

Important:

Let the sprayed color dry before applying masks. Remove masks very carefully after painting.

Where the mask is divided into A and B parts, first apply part A, next part B.

The set does not include masks for all areas, so mask the rest with masking tape or liquid mask.

K kit part

^ start placing the mask from this point

Placing wet masks on wet surface is recommended, except those marked by **W**

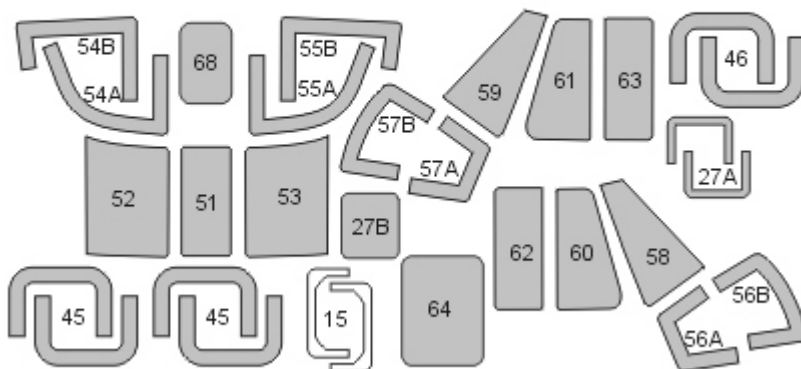
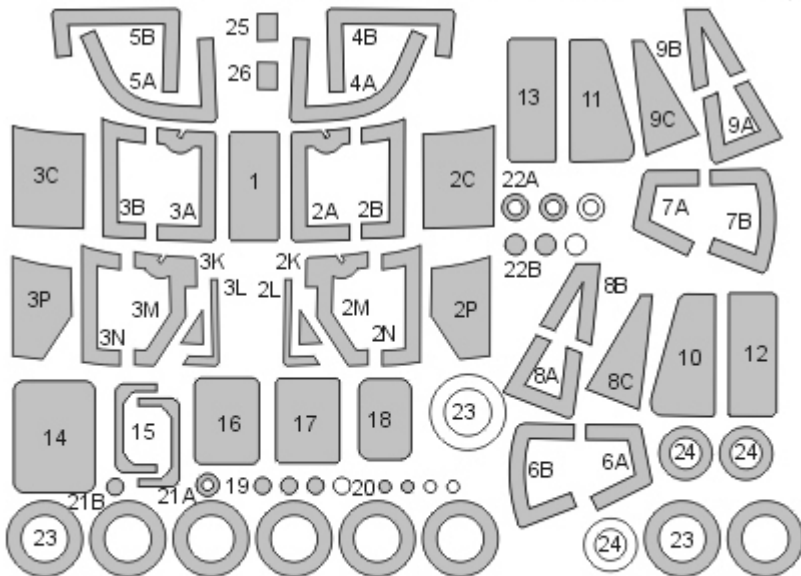

WHITE - SPARE MASKS

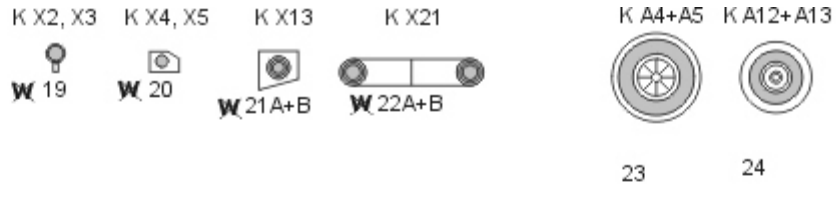

STEP 1 - exterior view
mask interior
paint camouflage color

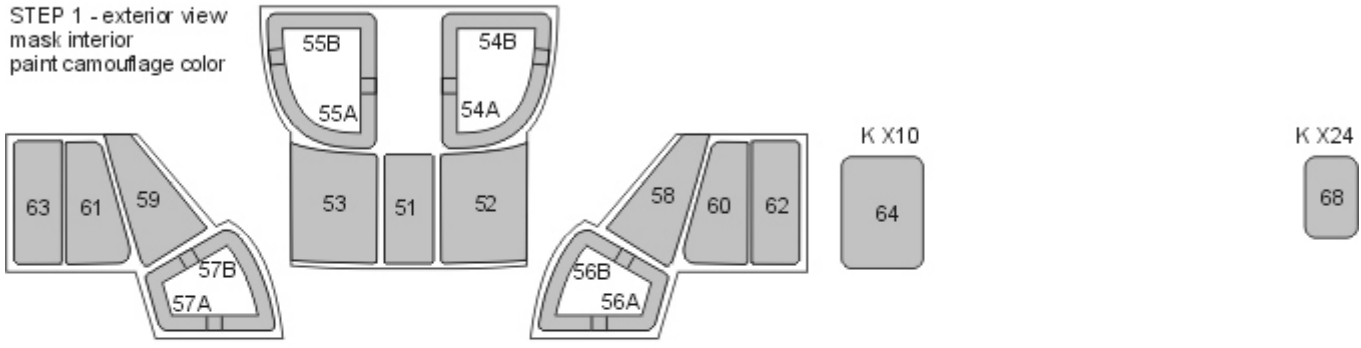

STEP 2
mask exterior
paint camouflage color

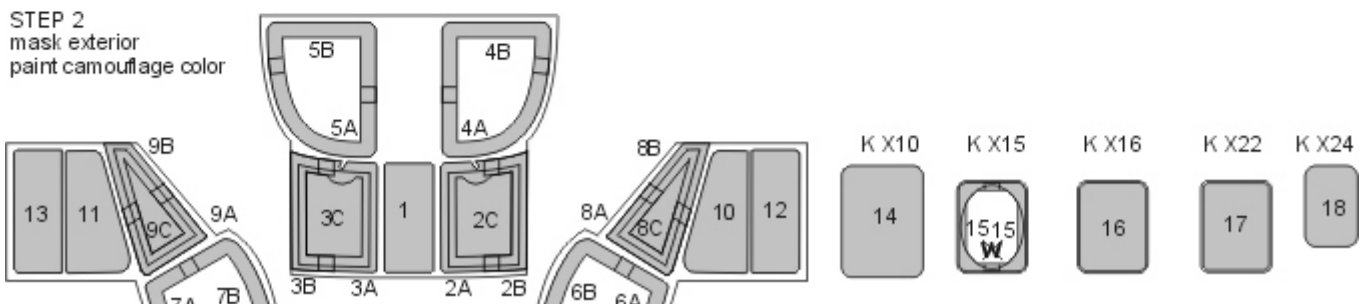

STEP 3
paint seal color (black)

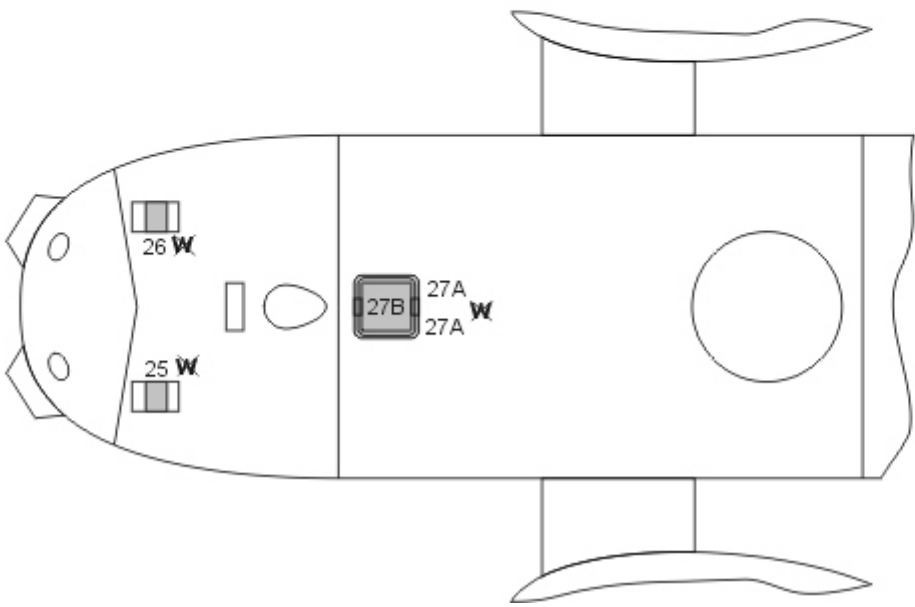
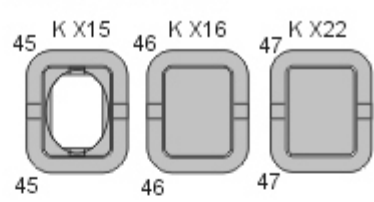



P-47D-25RE Thunderbolt BASIC kabuki masks

for MiniArt 48009 kit

<http://mek.kosmo.cz/newware>

tom.nwkits@seznam.cz

Important:

Let the sprayed color dry before applying masks. Remove masks very carefully after painting.

Where the mask is divided into A and B parts, first apply part A, next part B.

The set does not include masks for all areas, so mask the rest with masking tape or liquid mask.

K kit part

^ start placing the mask from this point

Placing wet masks on wet surface is recommended, except those marked by **W**

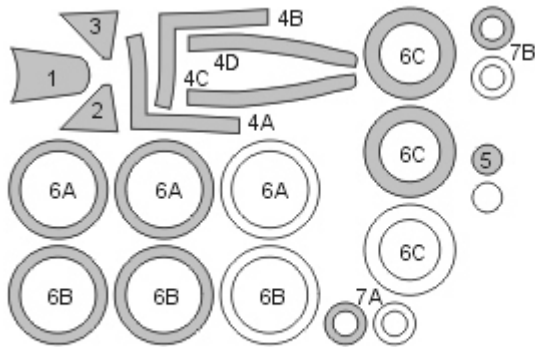

WHITE - SPARE MASKS

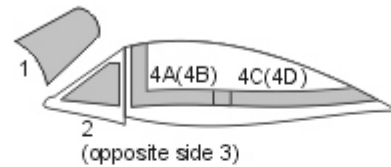

K D1+D3+(Cd1,Cd2,Cd3)
D2+D4+(Cd1,Cd2,Cd3)

K Gb5



5

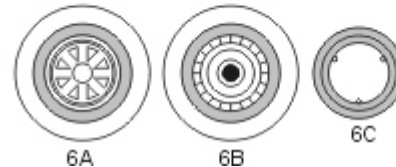

K D20(D21)



7A 7B



P-47D-25RE Thunderbolt EXPERT kabuki masks
for MiniArt 48009 kit
<http://mek.kosmo.cz/newware>

INCLUDES ALSO AIRCRAFT
CANOPY INNER SIDE AND
BOMBS YELLOW STRIPES MASKS

tom.nwkits@seznam.cz

Important:

Let the sprayed color dry before applying masks. Remove masks very carefully after painting.
Where the mask is divided into A and B parts, first apply part A, next part B.
The set does not include masks for all areas, so mask the rest with masking tape or liquid mask.

K kit part

^ start placing the mask from this point

Placing wet masks on wet surface is recommended, except those marked by **W**

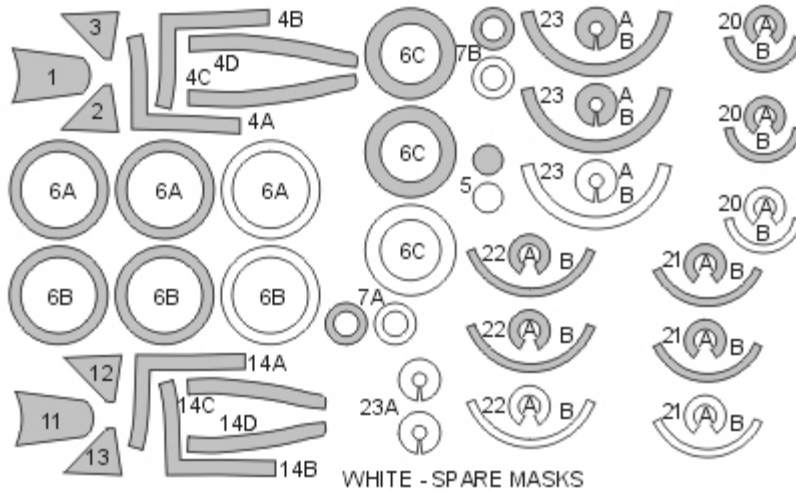

STEP 1 - exterior view
mask interior, paint interior color

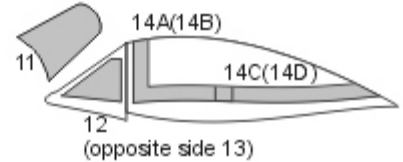

STEP 2
mask exterior, paint camouflage color

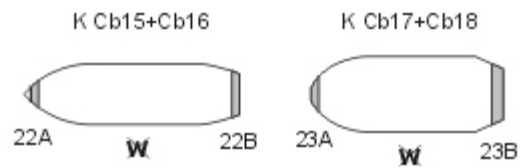
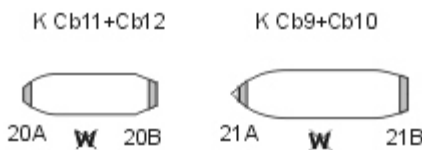
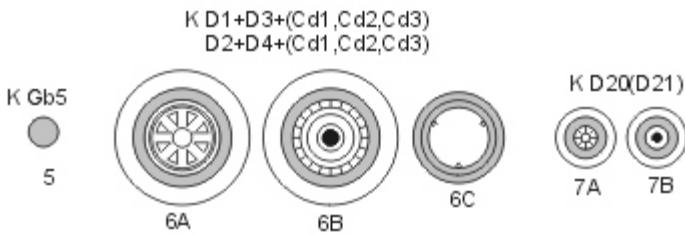
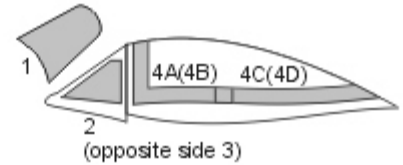

NWAM1163

1/48 scale



F-35B Lightning II BASIC kabuki masks

for Tamiya 61125 kit

<http://mek.kosmo.cz/newware>

tom.nwkits@seznam.cz

USE ALSO NWAM165 F-35B CAMOUFLAGE KABUKI MASKS

Important:

Let the sprayed color dry before applying masks. Remove masks very carefully after painting.

Where the mask is divided into A and B parts, first apply part A, next part B.

The set does not include masks for all areas, so mask the rest with masking tape or liquid mask.

K kit part

^ start placing the mask from this point

Placing wet masks on wet surface is recommended, except those marked by **W**

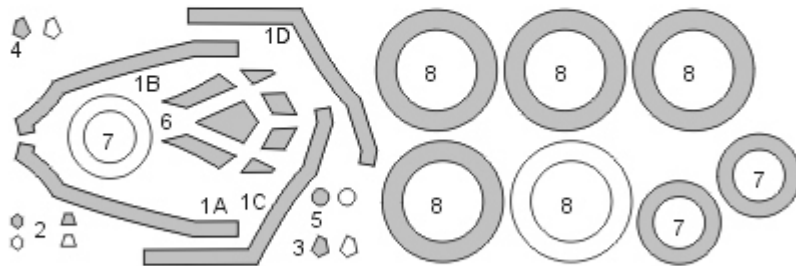

white - spare parts

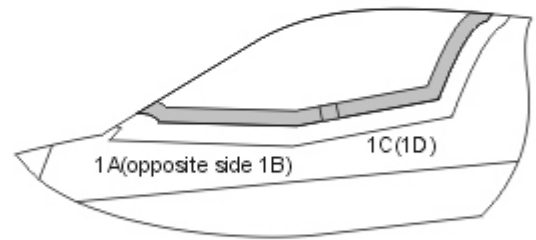

K E5+E4



7

K C12+A57



8

K B1



6

K B2



2

K B3



3

K B4



4

K B5



5



NWAM1164

F-35B Lightning II EXPERT kabuki masks

for Tamiya 61125 kit

<http://mek.kosmo.cz/newware>

INCLUDES ALSO WINDOWS
INNER SIDE, WEAPON YELLOW
STRIPES AND ENGINES MASKS

1/48 scale

tom.nwkits@seznam.cz

USE ALSO NWAM165 F-35B CAMOUFLAGE KABUKI MASKS

Important:

Let the sprayed color dry before applying masks. Remove masks very carefully after painting.
Where the mask is divided into A and B parts, first apply part A, next part B.
The set does not include masks for all areas, so mask the rest with masking tape or liquid mask.

K kit part

^ start placing the mask from this point

Placing wet masks on wet surface is recommended, except those marked by **W**

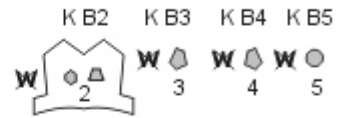
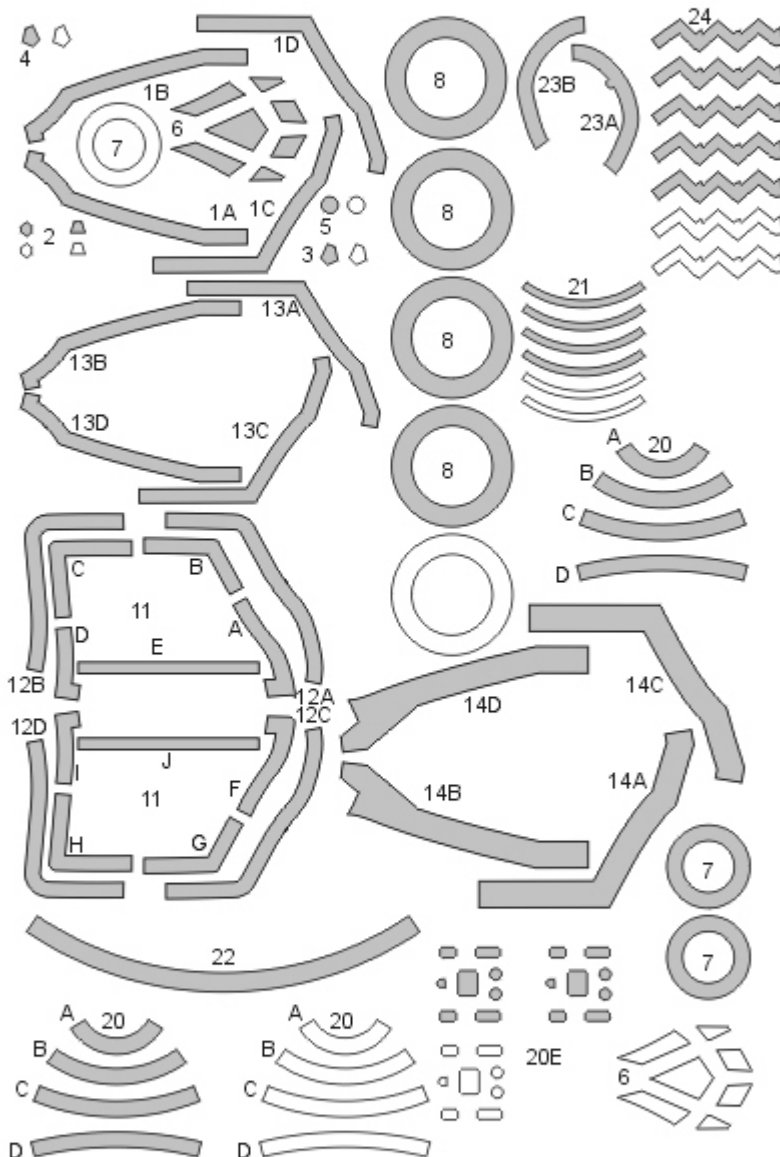

STEP 1 - exterior view
mask interior, paint "heating" color

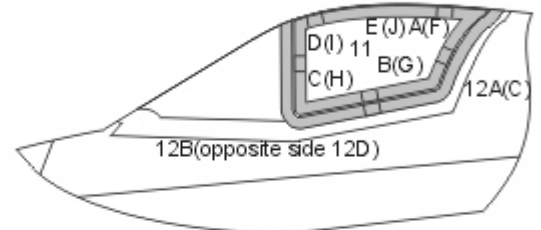

STEP 2 - exterior view
mask interior, paint interior color

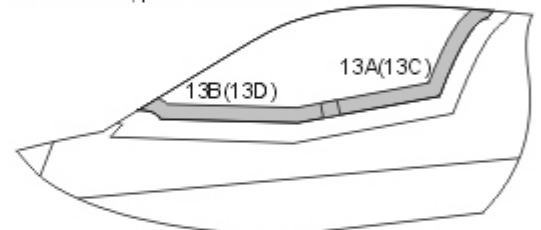

STEP 3
mask exterior, paint frame color

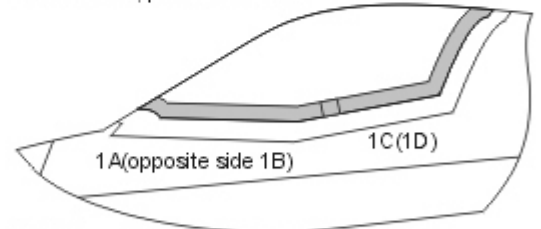

STEP 4
mask exterior, paint camouflage color

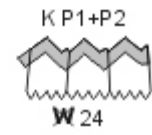
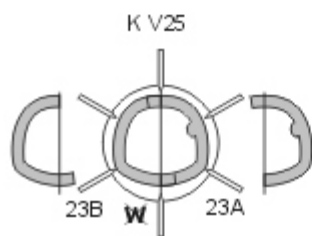
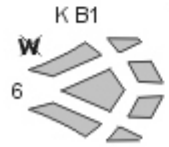
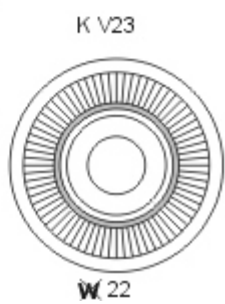
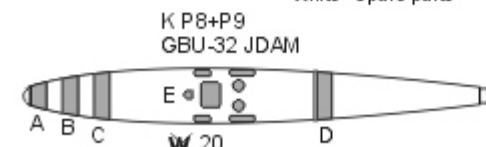
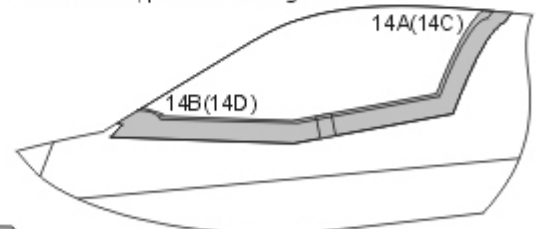



F-35B Lightning II CAMOUFLAGE kabuki masks

for Tamiya 61125 kit

<http://mek.kosmo.cz/newware>

tom.nwkits@seznam.cz

USE ALSO NWAM164 F-35B EXPERT KABUKI MASKS

Important:

Let the sprayed color dry before applying masks. Remove masks very carefully after painting.
 Where the mask is divided into A and B parts, first apply part A, next part B.
 The set does not include masks for all areas, so mask the rest with masking tape or liquid mask.

K kit part

* start placing the mask from this point

Placing wet masks on wet surface is recommended, except those marked by **W**

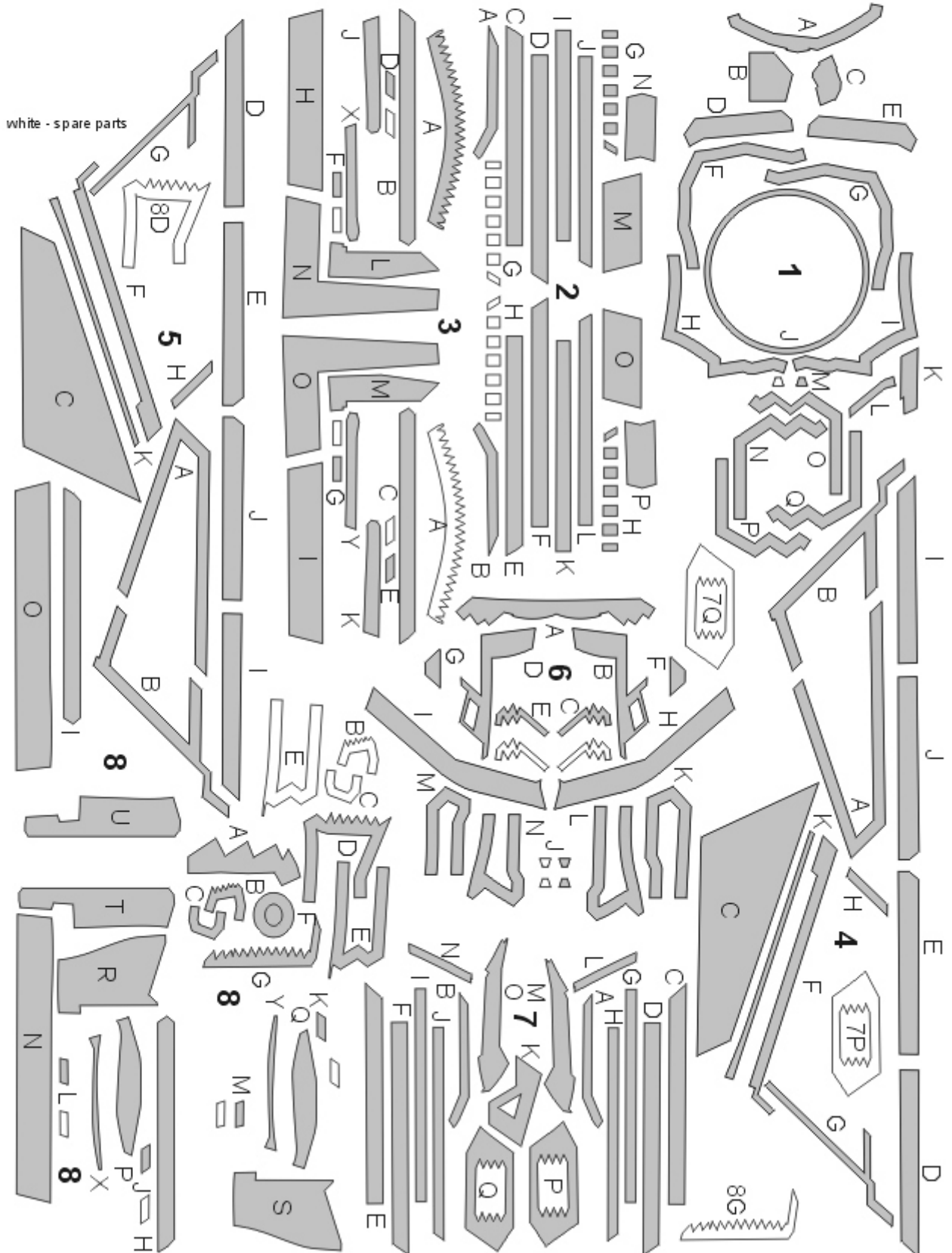

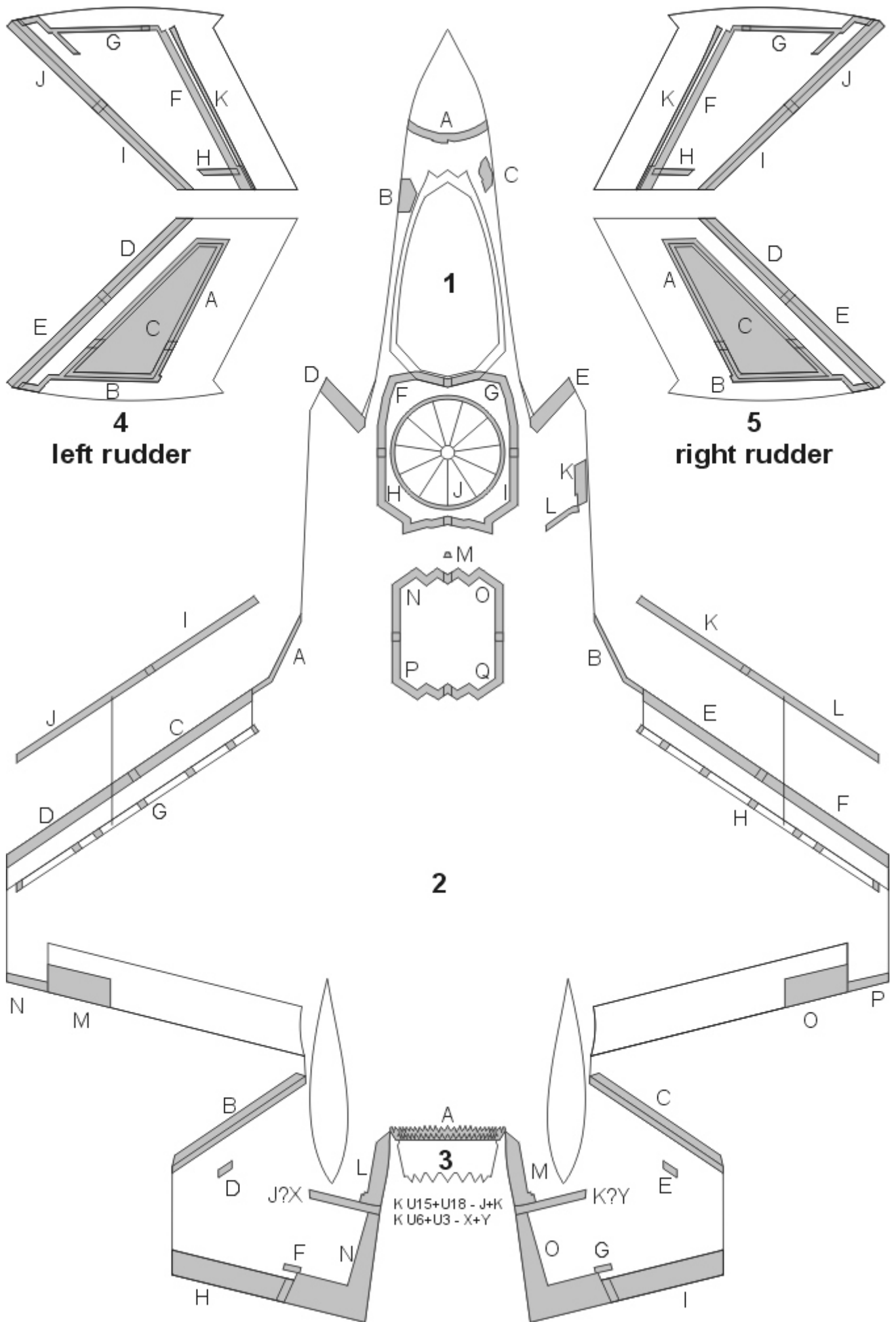

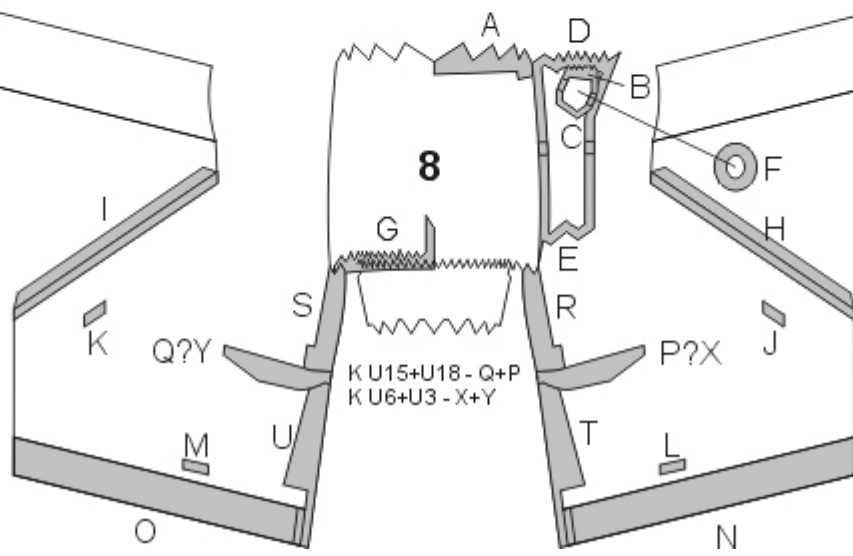
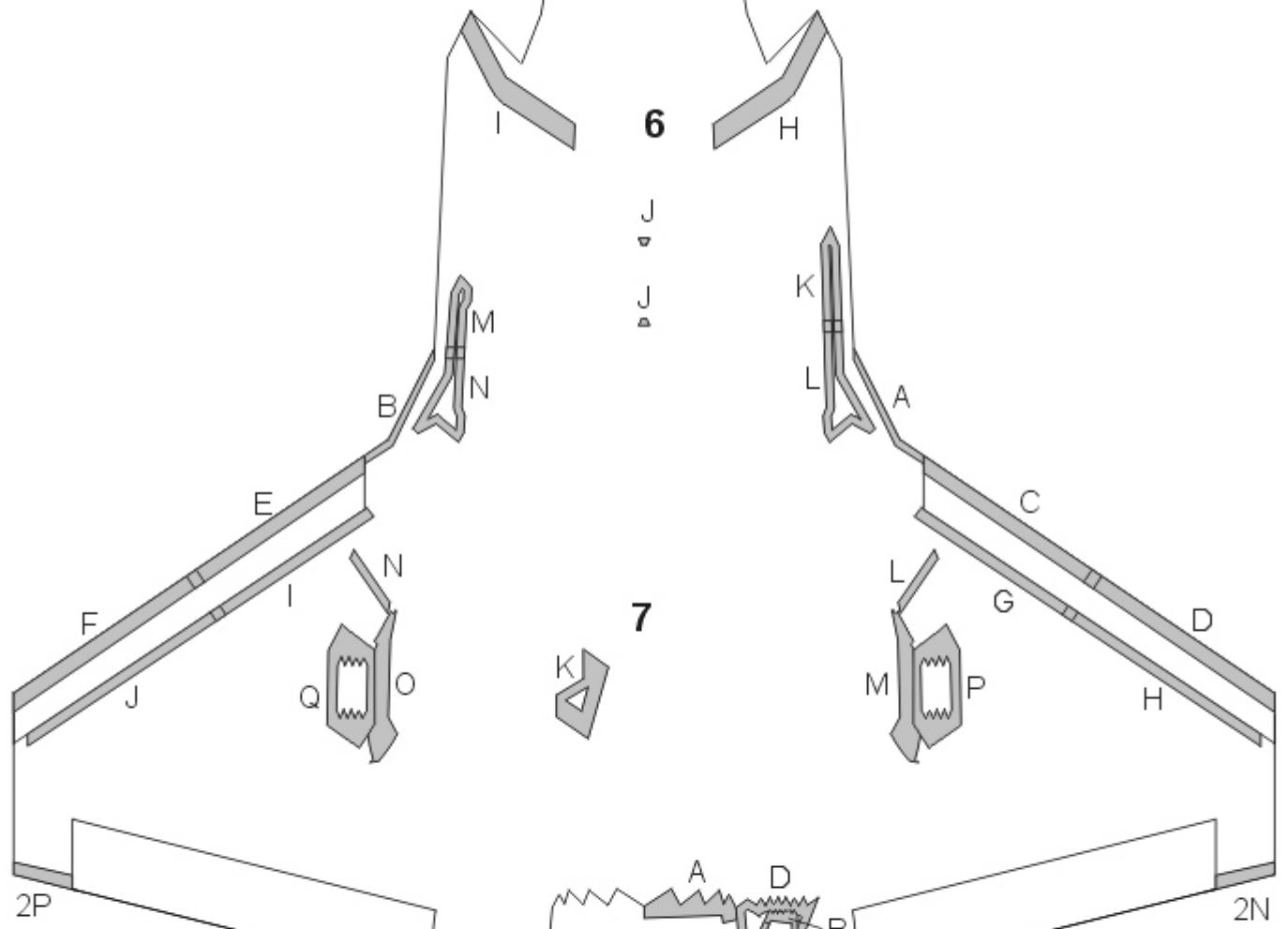
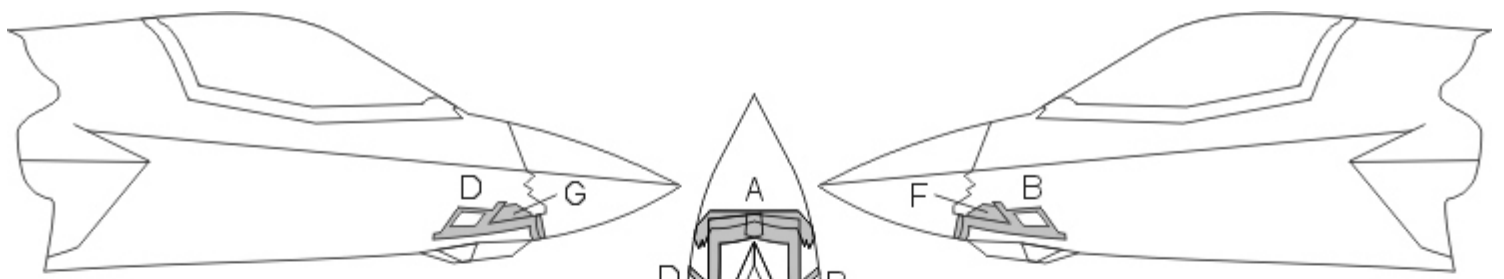

6

7

8