



NEW WARE NEWSLETTER

NEW MASKS NOVEMBER 2023

NWAM 1148 1/48 F-89(C, D/ J) Scorpi on ADVANCED kabuki masks	Revell
NWAM 1149 1/48 F-89(C, D/ J) Scorpi on EXPERT kabuki masks	Revell
NWAM 1150 1/48 F-14B Tomcat BASIC kabuki masks	GW.H
NWAM 1151 1/48 F-14B Tomcat EXPERT kabuki masks	GW.H
NWAM 1152 1/48 F-14B Tomcat EXHAUST NOZZLESkabuki masks	GW.H
NWAM 1153 1/48 Mi 2 BASIC kabuki masks	Aeroplast
NWAM 1154 1/48 Mi 2 ADVANCED kabuki masks	Aeroplast
NWAM 1155 1/48 Mi 2 EXPERT kabuki masks	Aeroplast
NWAM 1156 1/72 RF-4EJBASIC kabuki masks	Fine Molds
NWAM 1157 1/72 RF-4EJADVANCED kabuki masks	Fine Molds
NWAM 1158 1/72 RF-4EJEXPERT kabuki masks	Fine Molds



F-89 (C, D/J) Scorpion ADVANCED kabuki masks

for Revell No. 5650, 4825, 4568 kits

<http://mek.kosmo.cz/newware>

tom.nwkits@seznam.cz

Important:

Let the sprayed color dry before applying masks. Remove masks very carefully after painting.
Where the mask is divided into A and B parts, first apply part A, next part B.
The set does not include masks for all areas, so mask the rest with masking tape or liquid mask.

K kit part

* start placing the mask from this point

Placing wet masks on wet surface is recommended, except those marked by **W**

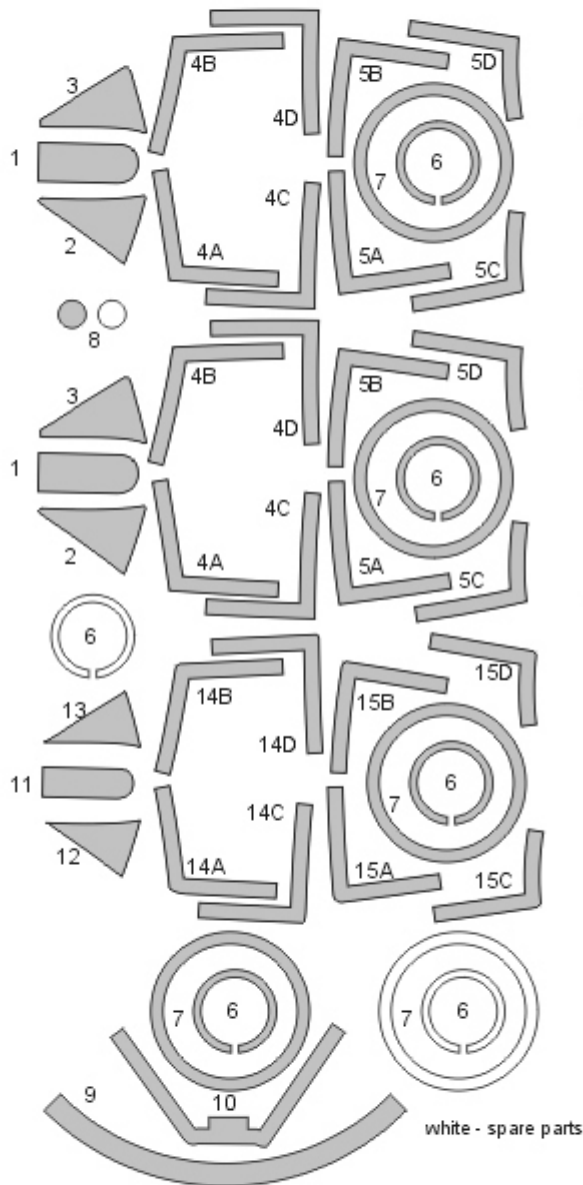

STEP 1 paint interior color

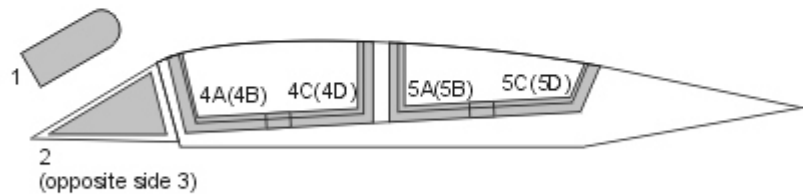

STEP 2 paint frame color

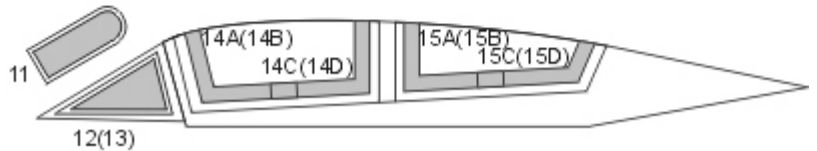

STEP 3 paint exterior color

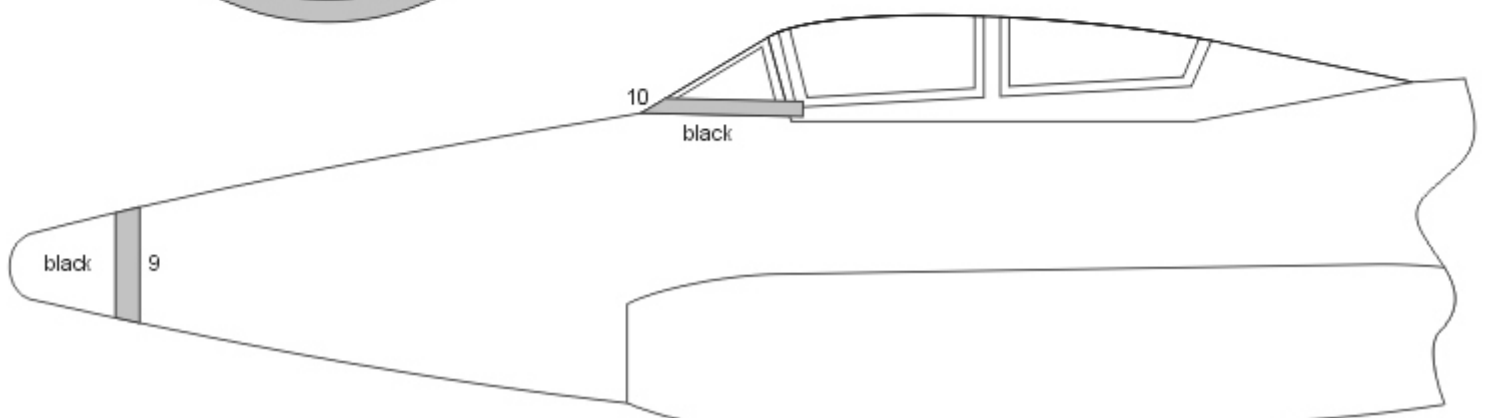
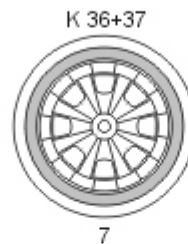
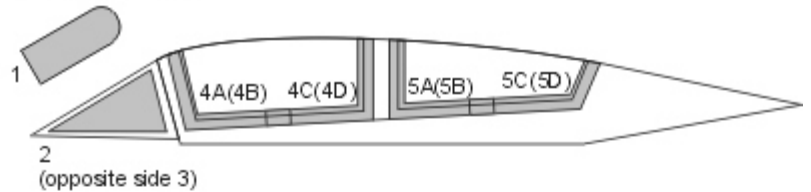



F-89 (C, D/J) Scorpion EXPERT kabuki masks

for Revell No. 5650, 4825, 4568 kits

<http://mek.kosmo.cz/newware>

INCLUDES ALSO WINDOWS
INNER SIDE MASKS

tom.nwkits@seznam.cz

Important:

Let the sprayed color dry before applying masks. Remove masks very carefully after painting.
Where the mask is divided into A and B parts, first apply part A, next part B.
The set does not include masks for all areas, so mask the rest with masking tape or liquid mask.

K kit part

* start placing the mask from this point

Placing wet masks on wet surface is recommended, except those marked by **W**

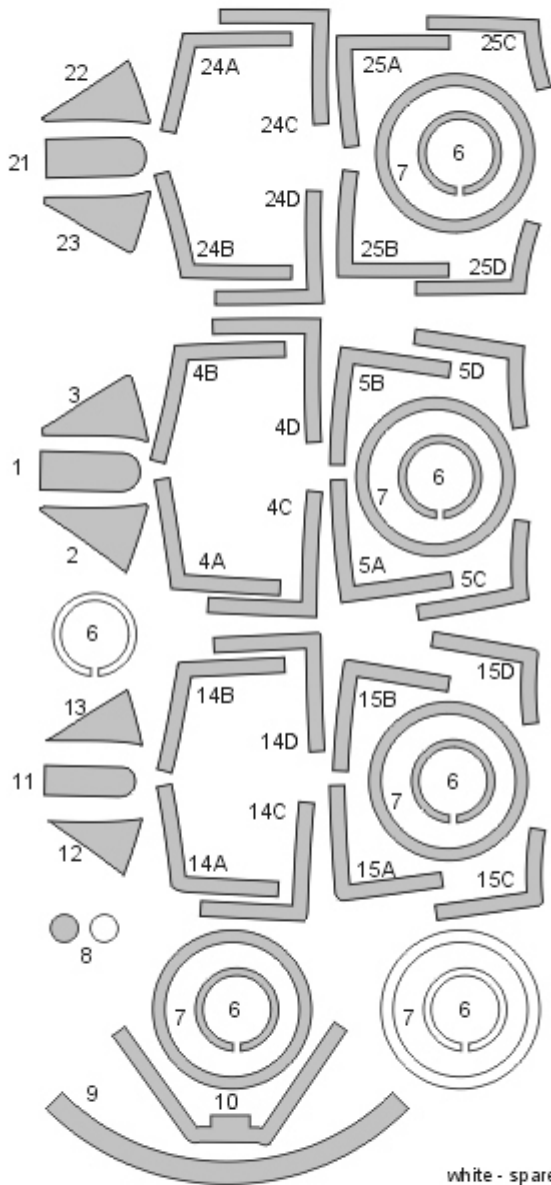

STEP 1 - exterior view
mask interior, paint interior color

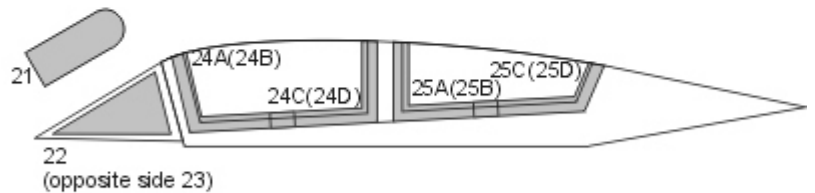

STEP 2
mask exterior, paint frame color

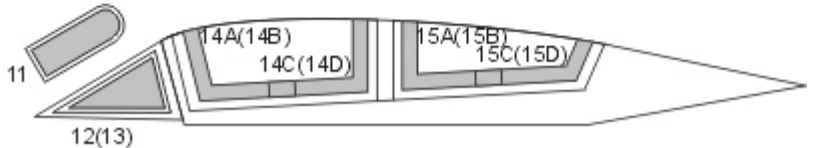

STEP 3
mask exterior, paint exterior color

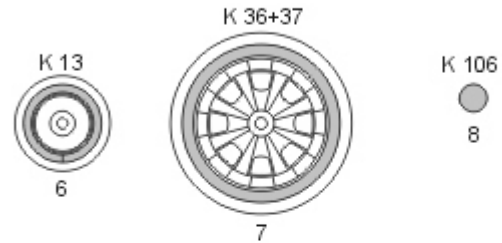
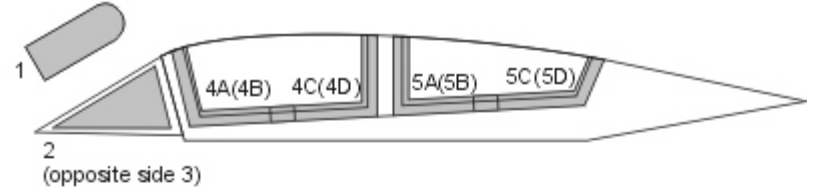

white - spare parts

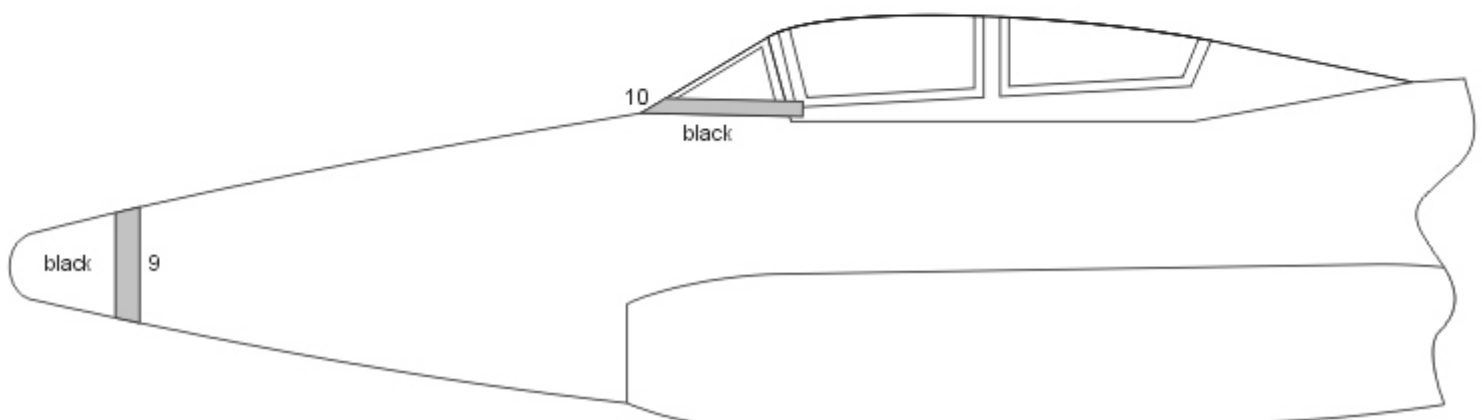



F-14B Tomcat BASIC kabuki masks

for G.W.H No. L4828 kit

<http://mek.kosmo.cz/newware>

tom.nwkits@seznam.cz

Important:

Let the sprayed color dry before applying masks. Remove masks very carefully after painting.

Where the mask is divided into A and B parts, first apply part A, next part B.

The set does not include masks for all areas, so mask the rest with masking tape or liquid mask.

K kit part

^ start placing the mask from this point

Placing wet masks on wet surface is recommended, except those marked by **W**

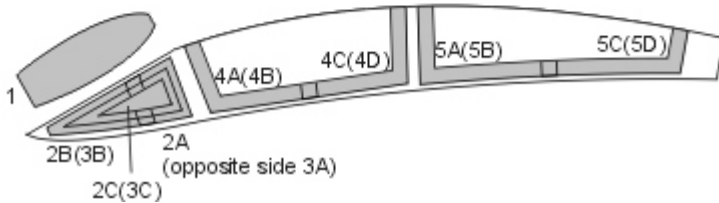
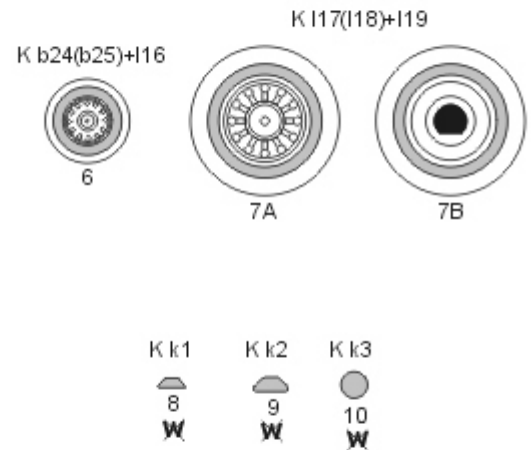
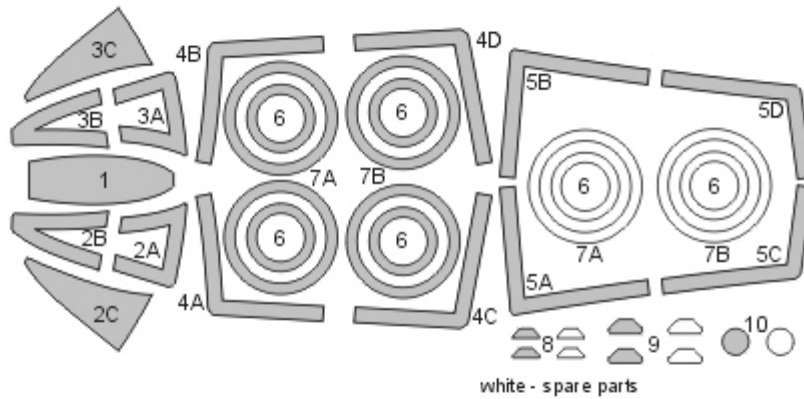



NWAM1151

F-14B Tomcat EXPERT kabuki masks

for G.W.H No. L4828 kit

<http://mek.kosmo.cz/newware>

INCLUDES ALSO WINDOWS
INNER SIDE MASKS

1/48 scale

tom.nwkits@seznam.cz

Important:

Let the sprayed color dry before applying masks. Remove masks very carefully after painting.

Where the mask is divided into A and B parts, first apply part A, next part B.

The set does not include masks for all areas, so mask the rest with masking tape or liquid mask.

K kit part

^ start placing the mask from this point

Placing wet masks on wet surface is recommended, except those marked by **W**

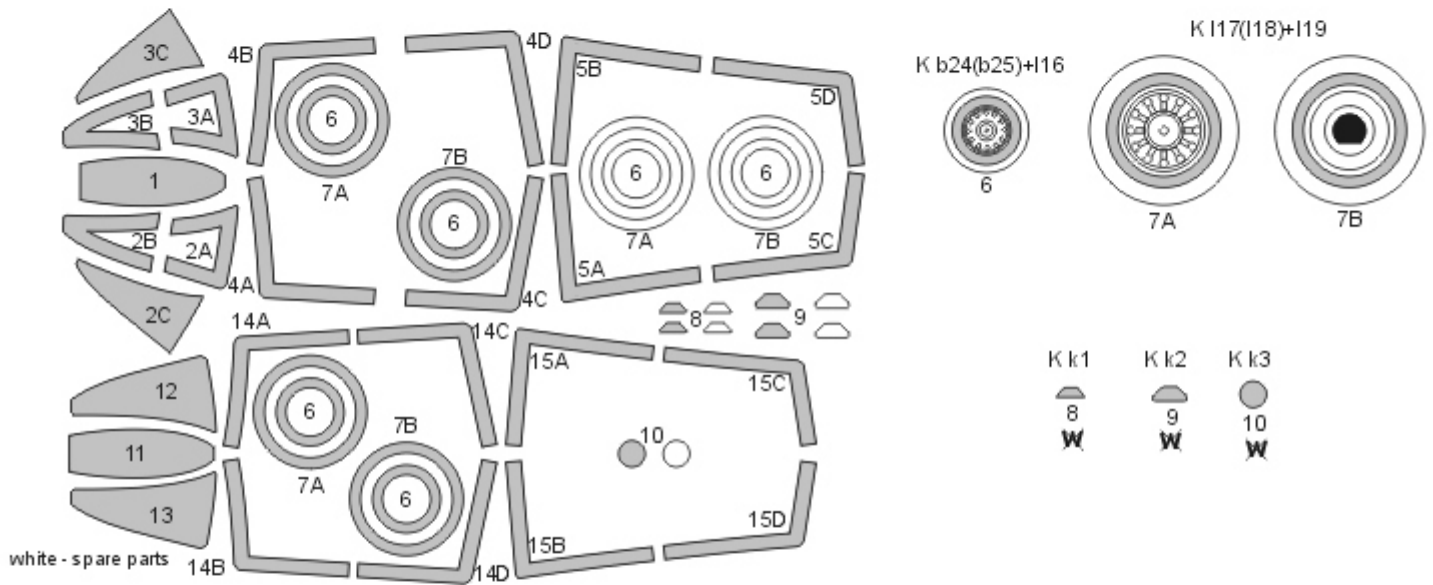

STEP 1 - exterior view
mask interior, paint interior color

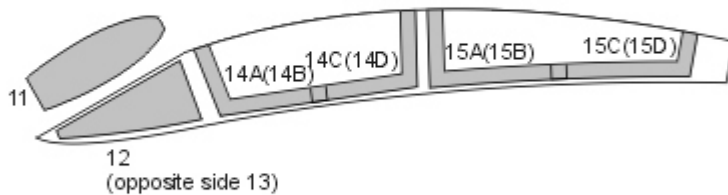

STEP 2
mask exterior, paint camouflage color

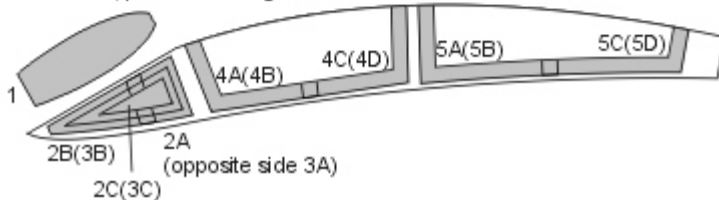



F-148 Tomcat EXHAUST NOZZLES kabuki masks

for G.W.H No. L4828 kit

<http://mek.kosmo.cz/newware>

tom.nwkits@seznam.cz

Important:

Let the sprayed color dry before applying masks. Remove masks very carefully after painting.

Where the mask is divided into A and B parts, first apply part A, next part B.

The set does not include masks for all areas, so mask the rest with masking tape or liquid mask.

K kit part

^ start placing the mask from this point

Placing wet masks on wet surface is recommended, except those marked by **W**



white - spare parts

k Q1+X1

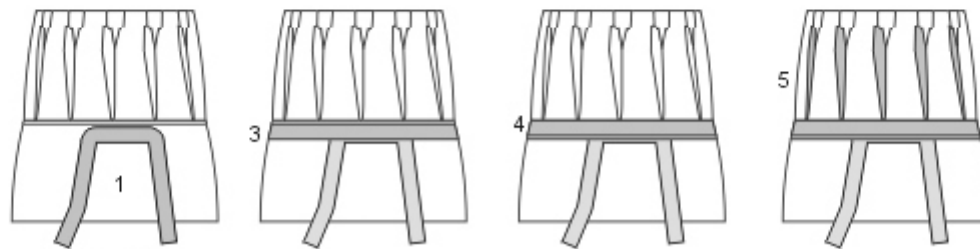

2 for k Q2+X1



Mi 2 BASIC kabuki masks
for Aeroplast No. 90035-90039 kits
<http://mek.kosmo.cz/newware>

tom.nwkits@seznam.cz

Important:

Let the sprayed color dry before applying masks. Remove masks very carefully after painting.
Where the mask is divided into A and B parts, first apply part A, next part B.
The set does not include masks for all areas, so mask the rest with masking tape or liquid mask.

K kit part

* start placing the mask from this point

Placing wet masks on wet surface is recommended, except those marked by **W**

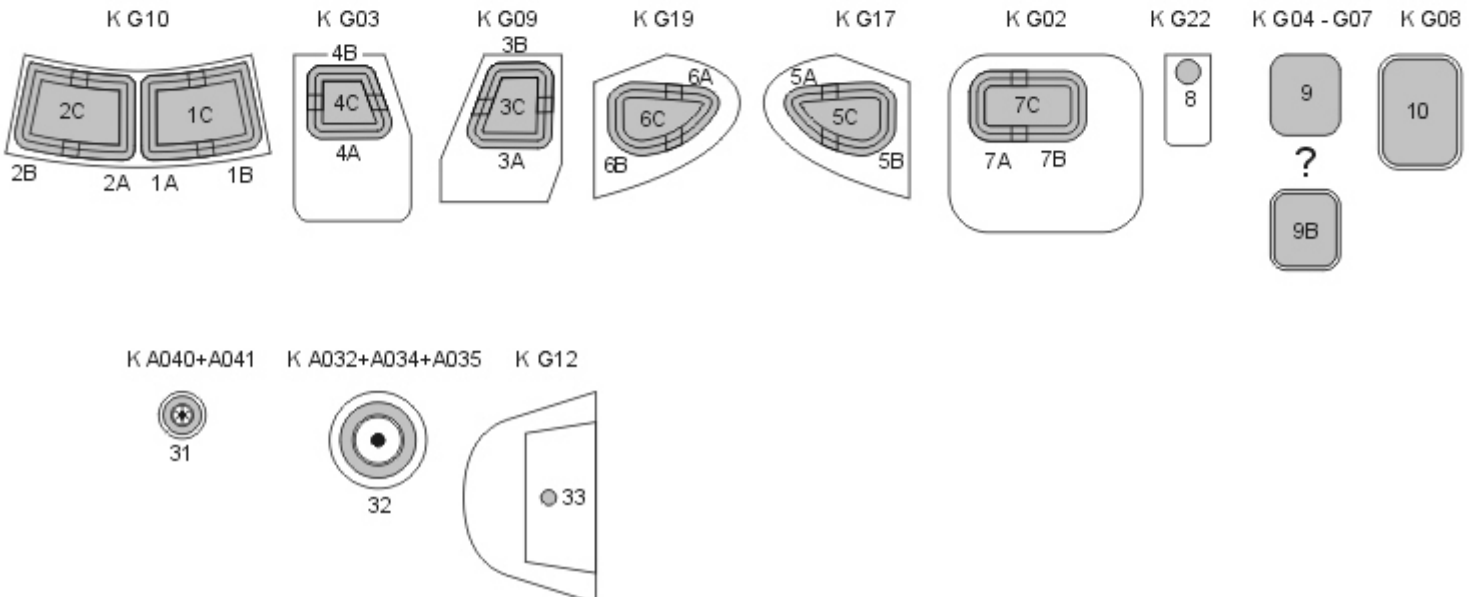
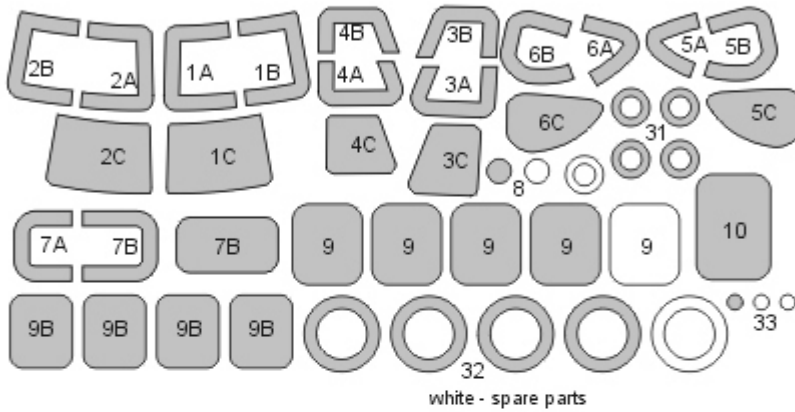



NWAM1154

Mi 2 ADVANCED kabuki masks
for Aeroplast No. 90035-90039 kits
<http://mek.kosmo.cz/newware>

INCLUDES ALSO WINDOWS SEAL MASKS

1/48 scale

tom.nwkits@seznam.cz

Important:

Let the sprayed color dry before applying masks. Remove masks very carefully after painting.
Where the mask is divided into A and B parts, first apply part A, next part B.
The set does not include masks for all areas, so mask the rest with masking tape or liquid mask.

K kit part

* start placing the mask from this point

Placing wet masks on wet surface is recommended, except those marked by **W**

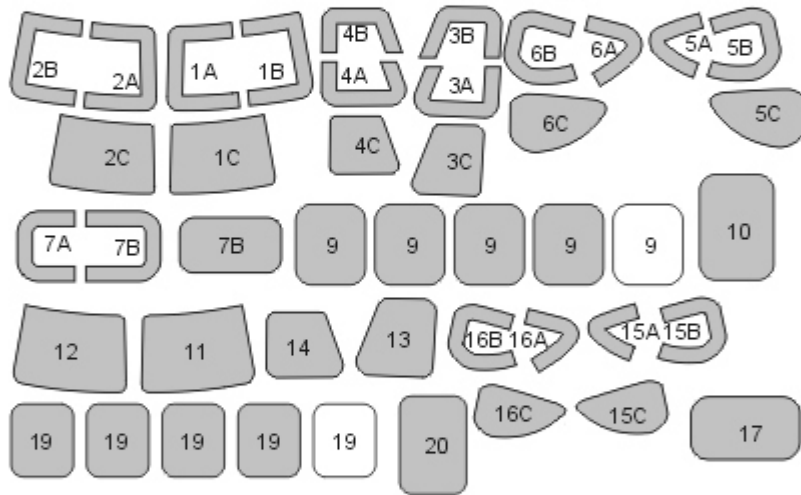
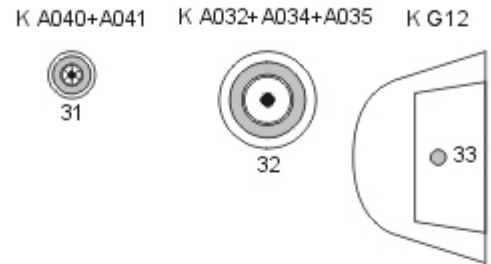
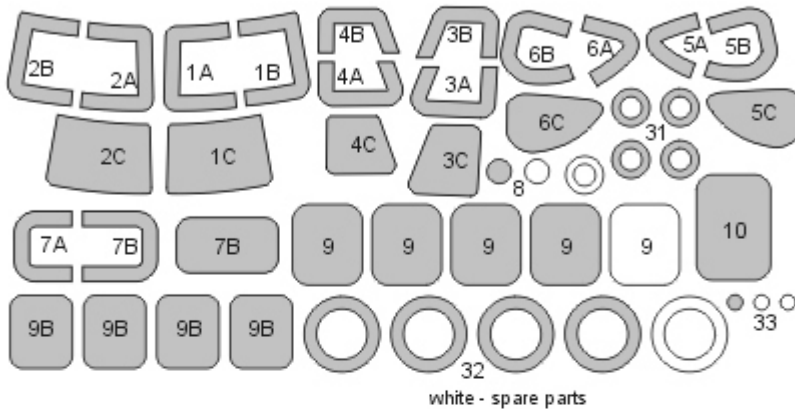

STEP 1 paint interior color

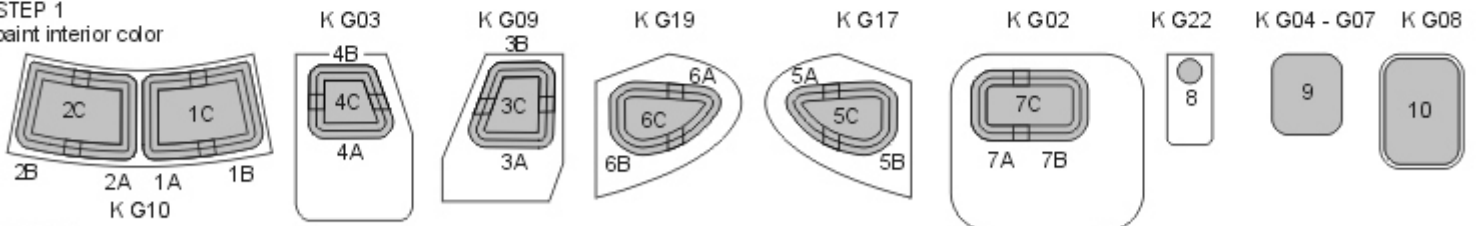

STEP 2 paint seal color (black)

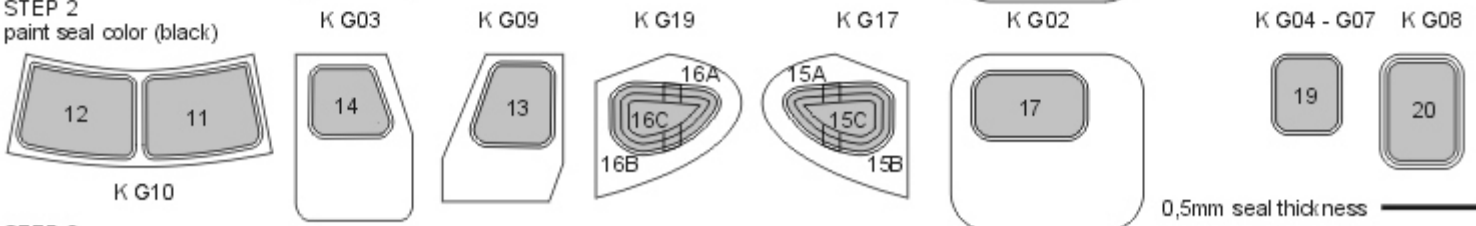

STEP 3 paint camouflage color

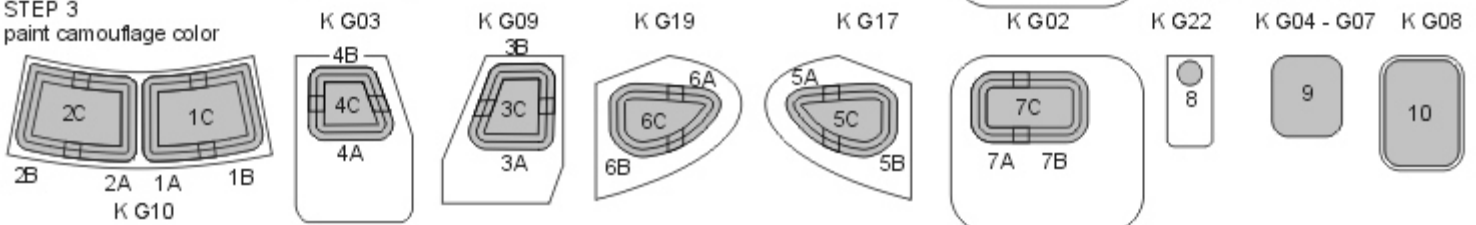

0,5mm seal thickness



Mi 2 EXPERT kabuki masks
for Aeroplast No. 90035-90039 kits
http://mek.kosmo.cz/new_ware

INCLUDES ALSO WINDOWS
SEAL AND INNER SIDE MASKS

tom.nwkits@seznam.cz

Important:

Let the sprayed color dry before applying masks. Remove masks very carefully after painting.
Where the mask is divided into A and B parts, first apply part A, next part B.
The set does not include masks for all areas, so mask the rest with masking tape or liquid mask.

K kit part

^ start placing the mask from this point

Placing wet masks on wet surface is recommended, except those marked by **W**

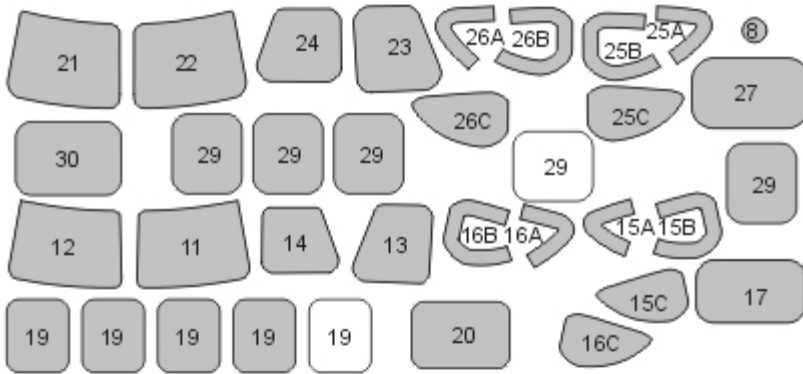
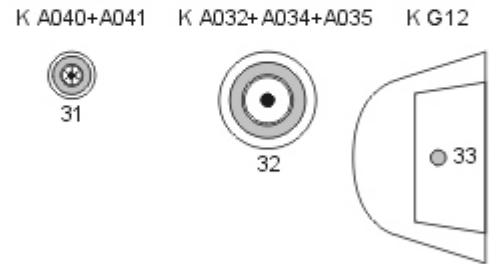
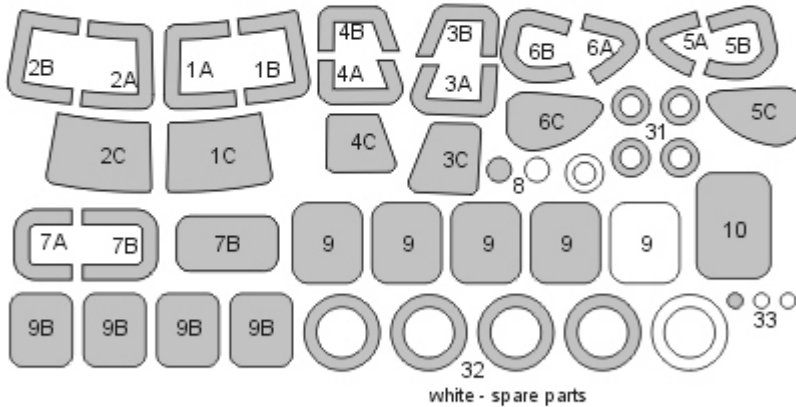

STEP 1 - exterior view

mask interior, paint interior color

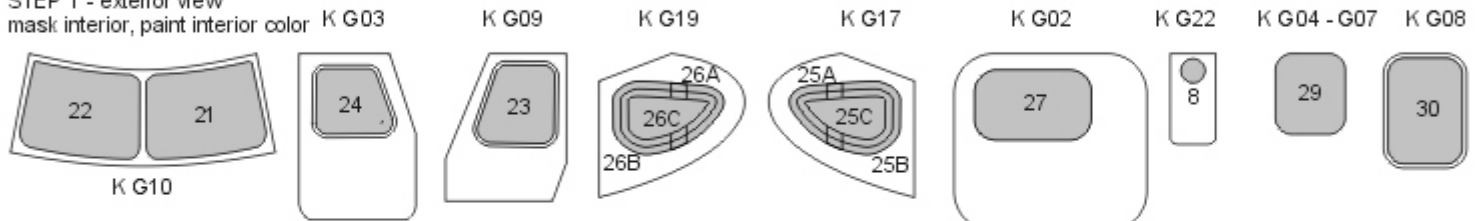

STEP 2
paint seal color (black)

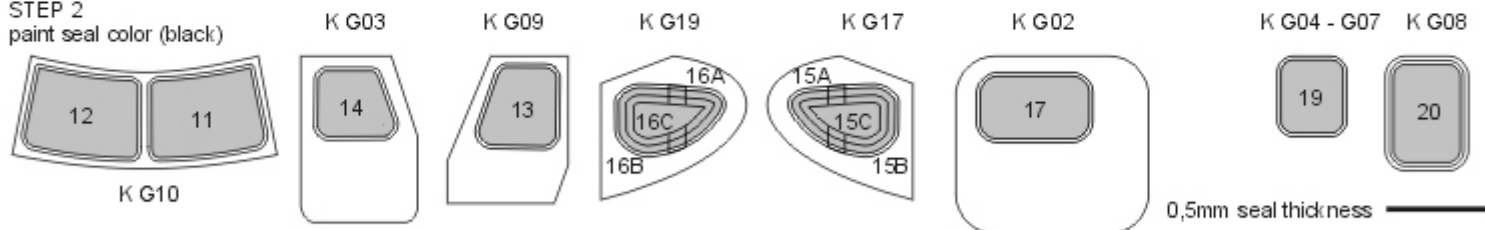

STEP 3
paint camouflage color

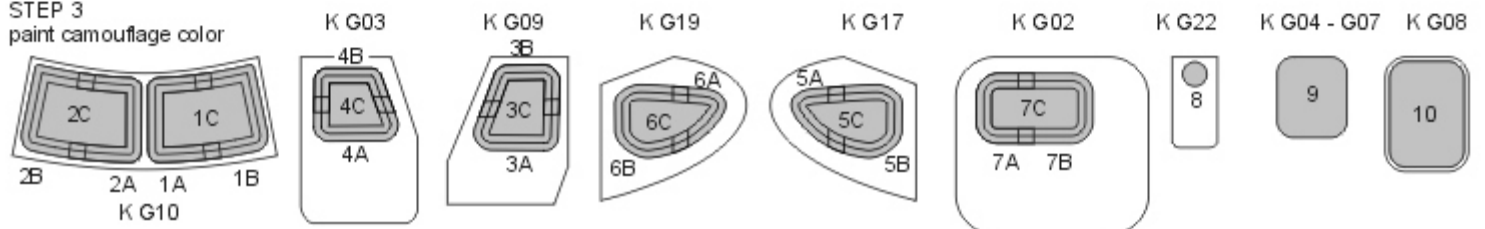



RF-4EJ BASIC kabuki masks
for Fine Molds FP42 and other kits
<http://mek.kosmo.cz/newware>

tom.nwkits@seznam.cz

Important:

Let the sprayed color dry before applying masks. Remove masks very carefully after painting.
Where the mask is divided into A and B parts, first apply part A, next part B.
The set does not include masks for all areas, so mask the rest with masking tape or liquid mask.

K kit part

^ start placing the mask from this point

Placing wet masks on wet surface is recommended, except those marked by **W**

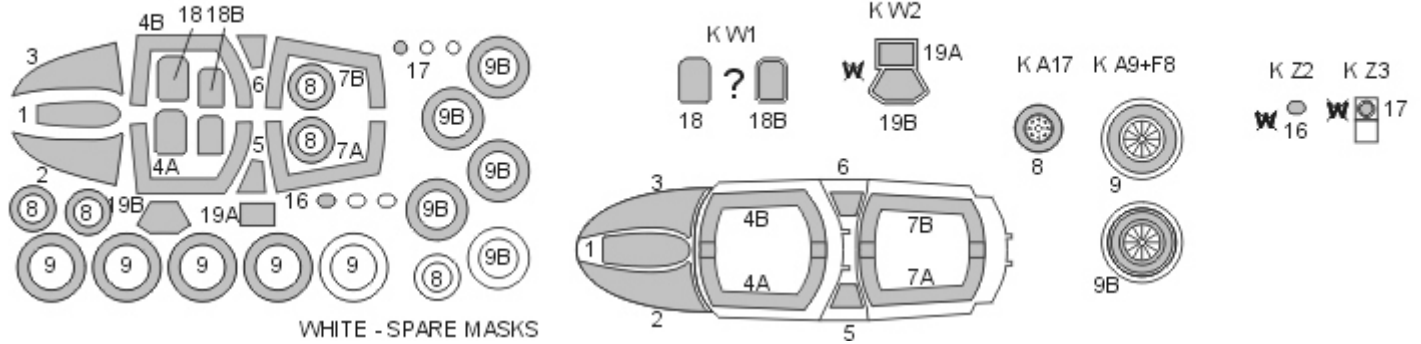



NWAM1157

RF-4EJ ADVANCED kabuki masks
for Fine Molds FP42 and other kits
<http://mek.kosmo.cz/newware>

INCLUDES ALSO WINDOWS
SEAL AND CAMOUFLAGE
DETAILS MASKS

1/72 scale

tom.nwkits@seznam.cz

Important:

Let the sprayed color dry before applying masks. Remove masks very carefully after painting.
Where the mask is divided into A and B parts, first apply part A, next part B.
The set does not include masks for all areas, so mask the rest with masking tape or liquid mask.

K kit part
^ start placing the mask from this point

Placing wet masks on wet surface is recommended, except those marked by **W**

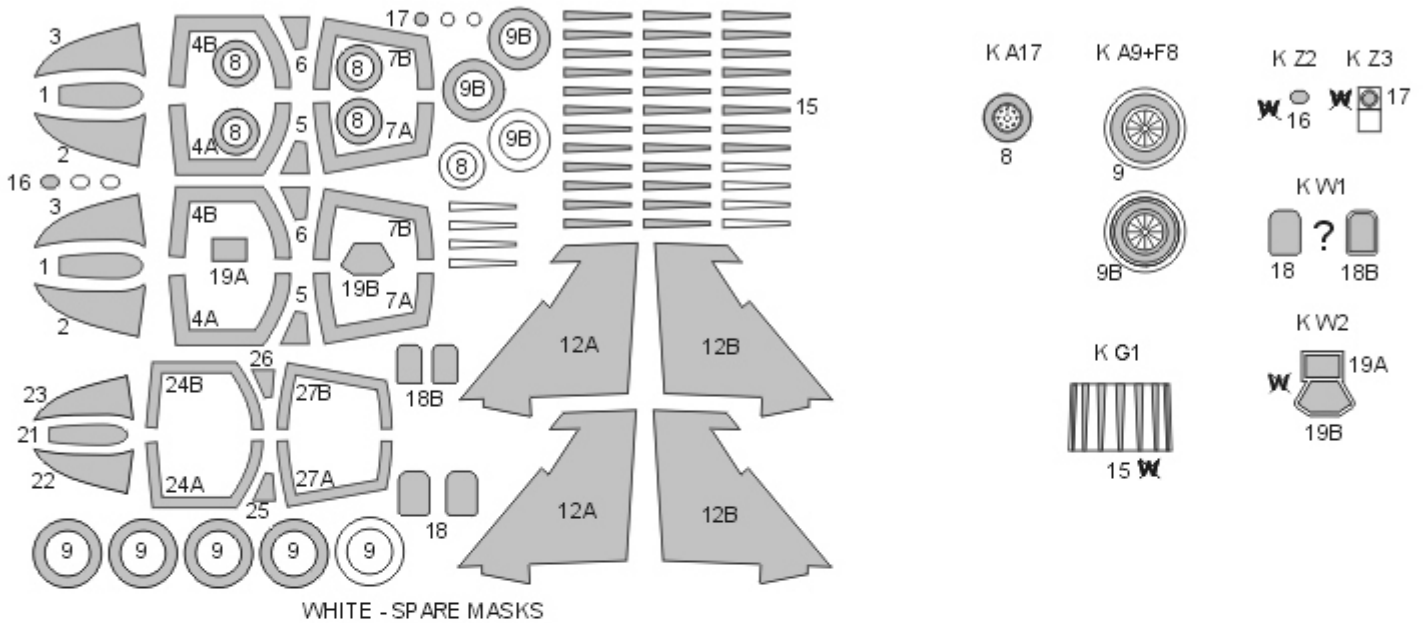

STEP 1
paint interior color

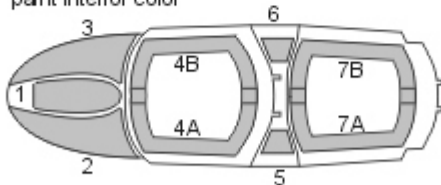

STEP 2
paint seal color

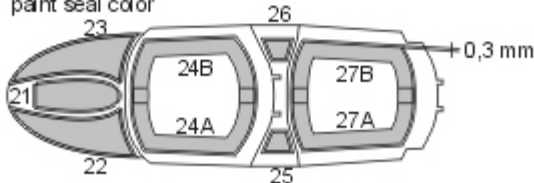

STEP 3
paint camouflage color

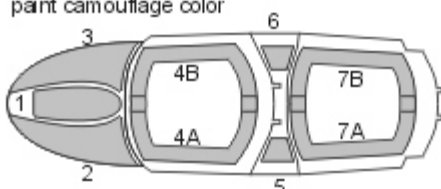

K L2-1, L2-2

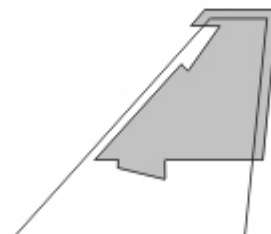

12A
opposite side 12B



NWAM1158

RF-4EJ EXPERT kabuki masks
for Fine Molds FP42 and other kits
<http://mek.kosmo.cz/newware>

INCLUDES ALSO WINDOWS
SEAL AND INNER SIDE AND
CAMOUFLAGE DETAILS MASKS

1/72 scale

tom.nwkits@seznam.cz

Important:

Let the sprayed color dry before applying masks. Remove masks very carefully after painting.
Where the mask is divided into A and B parts, first apply part A, next part B.
The set does not include masks for all areas, so mask the rest with masking tape or liquid mask.

K kit part

^ start placing the mask from this point

Placing wet masks on wet surface is recommended, except those marked by **W**

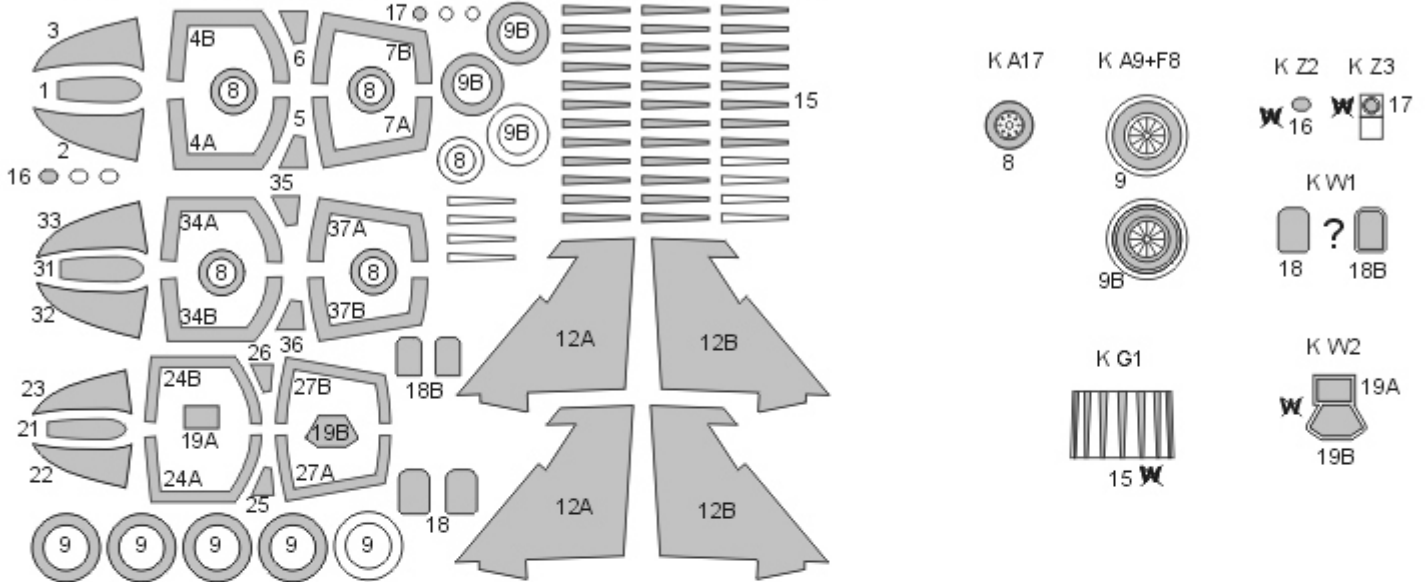

WHITE - SPARE MASKS

STEP 1 - exterior view
mask interior, paint interior color

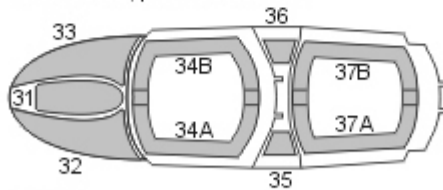

STEP 2
paint seal color

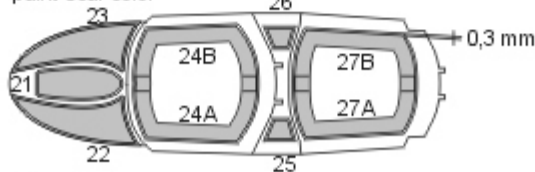

STEP 3
paint camouflage color

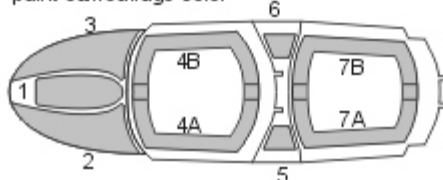

K L2-1, L2-2

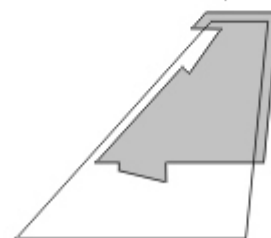

12A
opposite side 12B