



NEW WARE NEWSLETTER

NEW MASKS OCTOBER 2023

NWAM 1137 1/48 MIG-17F (Lim-5, Shenyang J-5) BASIC kabuki masks	Ammo by Mig Jmenez
NWAM 1138 1/48 MIG-17F (Lim-5, Shenyang J-5) EXPERT kabuki masks	Ammo by Mig Jmenez
NWAM 1139 1/48 Mi-17 Hip-H BASIC kabuki masks	Trumpeter
NWAM 1140 1/48 Mi-17 Hip-H EXPERT kabuki masks	Trumpeter
NWAM 1141 1/72 F-35A Lightning II BASIC kabuki masks	Tamiya
NWAM 1142 1/72 F-35A Lightning II EXPERT kabuki masks	Tamiya
NWAM 1143 1/72 MiG-29 Fulcrum A9-12 Late Type BASIC kabuki masks	G.W.H
NWAM 1144 1/72 MiG-29 Fulcrum A9-12 Late Type ADVANCED kabuki masks	G.W.H
NWAM 1145 1/72 MiG-29 Fulcrum A9-12 Late Type EXPERT kabuki masks	G.W.H
NWAM 1146 1/72 F/A-18A, F/A-18C Hornet BASIC kabuki masks	Academy
NWAM 1147 1/72 F/A-18A, F/A-18C Hornet EXPERT kabuki masks	Academy



MIG-17F Fresco C (Lim-5, Shenyang J-5) BASIC kabuki masks

for all Ammo by Mig Jimenez MIG-17F kits (8508-12, 85015...)

<http://mek.kosmo.cz/newware>

tom.nwkits@seznam.cz

Important:

Let the sprayed color dry before applying masks. Remove masks very carefully after painting.

Where the mask is divided into A and B parts, first apply part A, next part B.

The set does not include masks for all areas, so mask the rest with masking tape or liquid mask.

K kit part

^ start placing the mask from this point

Placing wet masks on wet surface is recommended, except those marked by **W**

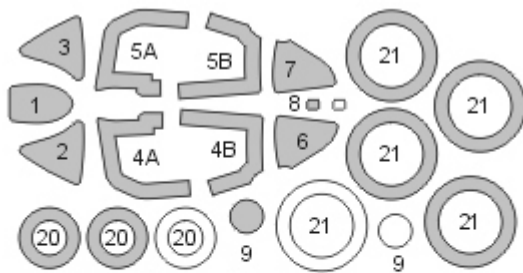

white - spare parts

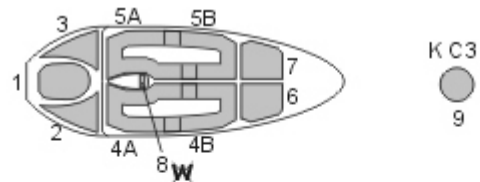

K B27+B28



20

K B33+B39



21

NWAM1138



MIG-17F Fresco C (Lim-5, Shenyang J-5) EXPERT kabuki masks

for all Ammo by Mig Jimenez MIG-17F kits (8508-12, 85015...)

<http://mek.kosmo.cz/newware>

INCLUDES ALSO WINDOWS
INNER SIDE MASKS

1/48 scale

tom.nwkits@seznam.cz

Important:

Let the sprayed color dry before applying masks. Remove masks very carefully after painting.

Where the mask is divided into A and B parts, first apply part A, next part B.

The set does not include masks for all areas, so mask the rest with masking tape or liquid mask.

K kit part

* start placing the mask from this point

Placing wet masks on wet surface is recommended, except those marked by **W**

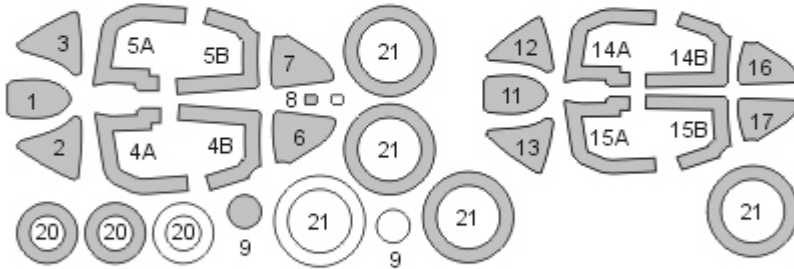

white - spare parts

K B27+B28



20

K B33+B39



21

STEP 1 - exterior view
mask interior, paint interior color

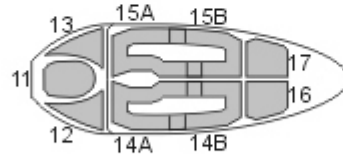

STEP 2
mask exterior, paint exterior color

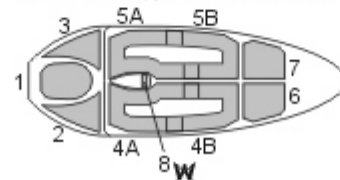

K C3



9



Mi-17 Hip-H BASIC kabuki masks

for Trumpeter No. 05814 kit

<http://mek.kosmo.cz/newware>

tom.nwkits@seznam.cz

Important:

Let the sprayed color dry before applying masks. Remove masks very carefully after painting.
 Where the mask is divided into A and B parts, first apply part A, next part B.
 The set does not include masks for all areas, so mask the rest with masking tape or liquid mask.

K kit part

* start placing the mask from this point

Placing wet masks on wet surface is recommended, except those marked by **W**

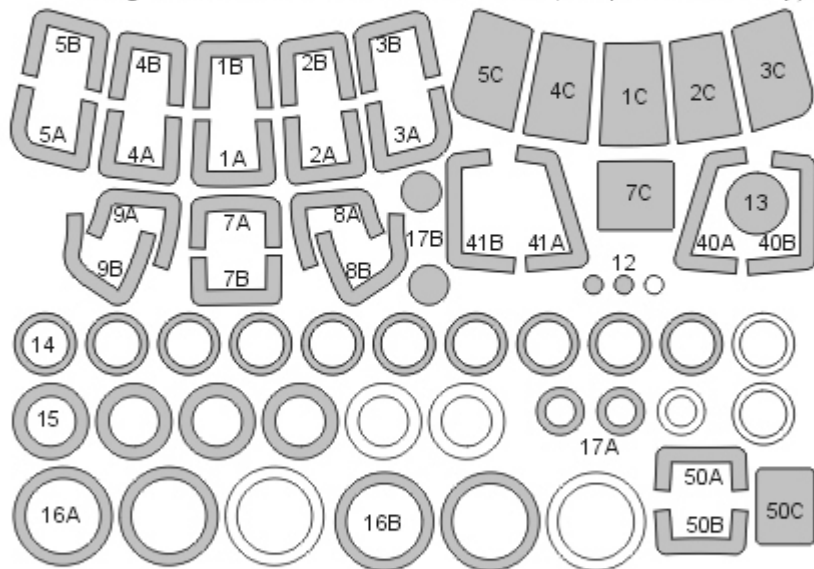

white - spare parts

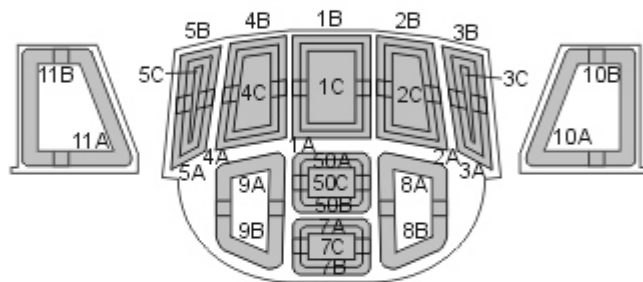

K GP3-2

K GP3-3

K GP3-6



K C21+C14

K C6+C31

K D16



15

16A

16B

17A+B **W**

NWAM1140

1/48 scale



Mi-17 Hip-H EXPERT kabuki masks

for Trumpeter No. 05814 kit

<http://mek.kosmo.cz/newware>

INCLUDES ALSO WINDOWS
INNER SIDE MASKS

tom.nwkits@seznam.cz

Important:

Let the sprayed color dry before applying masks. Remove masks very carefully after painting.
Where the mask is divided into A and B parts, first apply part A, next part B.
The set does not include masks for all areas, so mask the rest with masking tape or liquid mask.

K kit part

* start placing the mask from this point

Placing wet masks on wet surface is recommended, except those marked by **W**

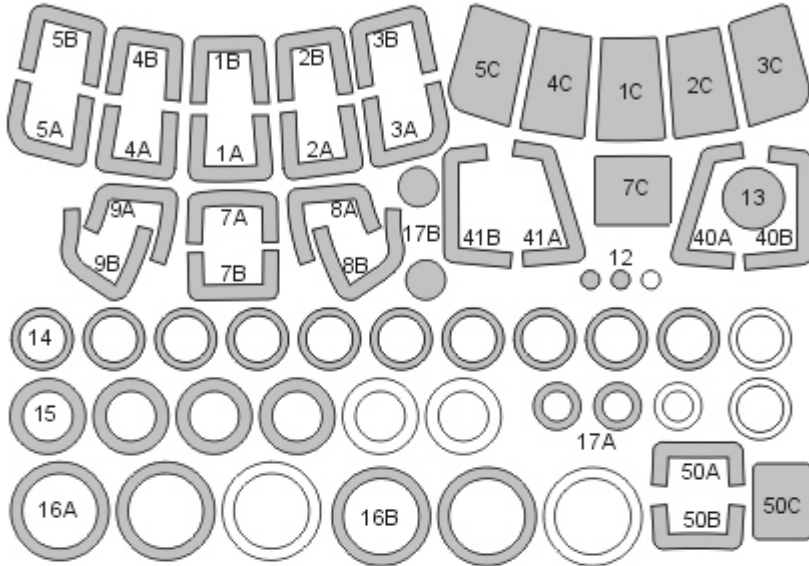

white - spare parts

K C21+C14



K C6+C31

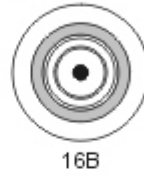

K D16

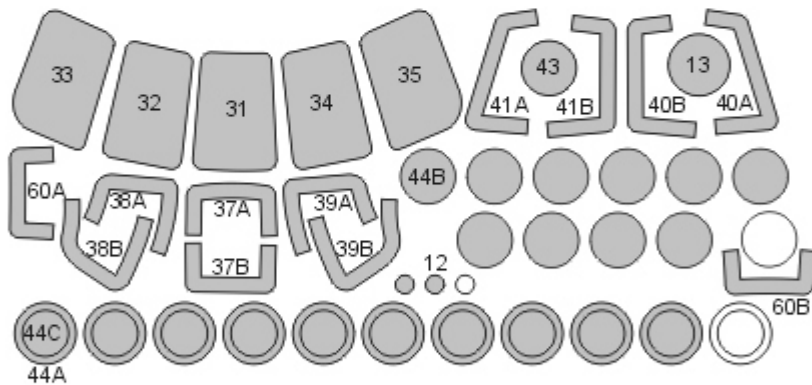

STEP 1 - exterior view

mask interior, paint interior color

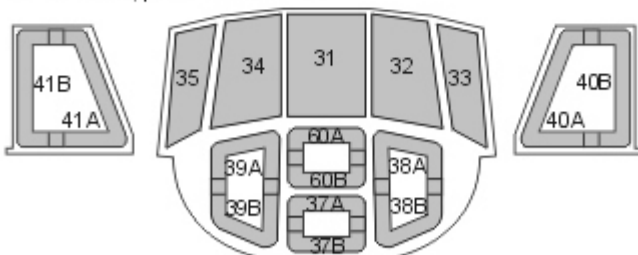

K GP 3-2



K GP 3-3

K GP 3-6

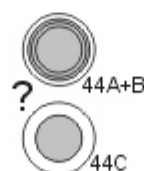

STEP 2

mask exterior, paint camouflage color

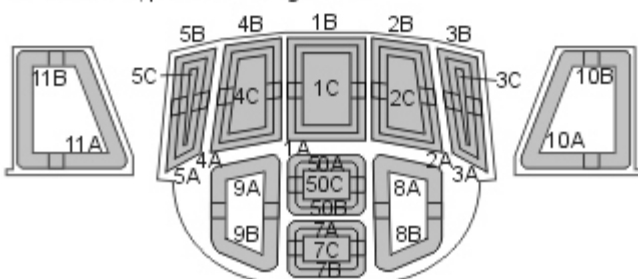

K GP 3-2



K GP 3-3

K GP 3-6





F-35A Lightning II BASIC kabuki masks

for Tamiya No. 60792 kit

<http://mek.kosmo.cz/newware>

tom.nwkits@seznam.cz

Important:

Let the sprayed color dry before applying masks. Remove masks very carefully after painting.

Where the mask is divided into A and B parts, first apply part A, next part B.

The set does not include masks for all areas, so mask the rest with masking tape or liquid mask.

K kit part

^ start placing the mask from this point

Placing wet masks on wet surface is recommended, except those marked by **W**

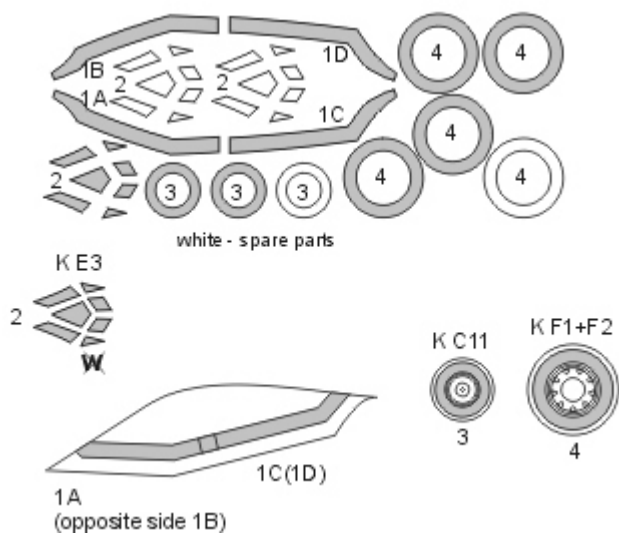



F-35A Lightning II BASIC kabuki masks

for Tamiya No. 60792 kit

<http://mek.kosmo.cz/newware>

INCLUDES ALSO WINDOWS
INNER SIDE AND CAMOUFLAGE
DETAILS MASKS

tom.nwkits@seznam.cz

Important:

Let the sprayed color dry before applying masks. Remove masks very carefully after painting.

Where the mask is divided into A and B parts, first apply part A, next part B.

The set does not include masks for all areas, so mask the rest with masking tape or liquid mask.

K kit part

* start placing the mask from this point

Placing wet masks on wet surface is recommended, except those marked by **W**

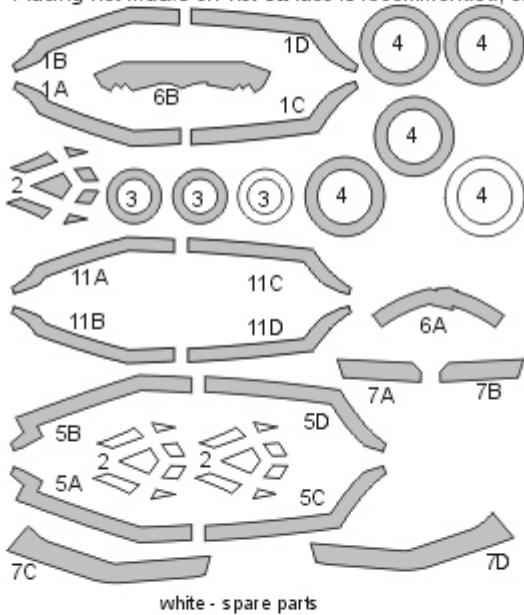

STEP 1 - exterior view mask interior, paint interior color

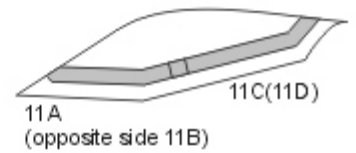

STEP 2 mask exterior, paint camouflage color

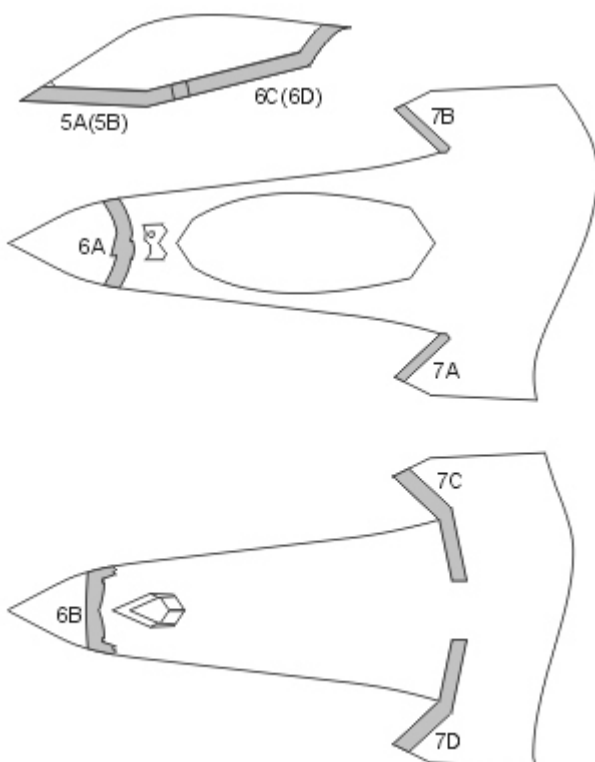
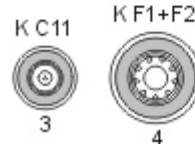
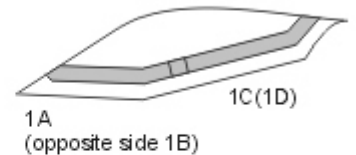



MiG-29 Fulcrum-A 9-12 Late Type BASIC kabuki masks

for G.W.H No. L7212 kit

<http://mek.kosmo.cz/newware>

tom.nwkits@seznam.cz

Important:

Let the sprayed color dry before applying masks. Remove masks very carefully after painting.

Where the mask is divided into A and B parts, first apply part A, next part B.

The set does not include masks for all areas, so mask the rest with masking tape or liquid mask.

K kit part

* start placing the mask from this point

Placing wet masks on wet surface is recommended, except those marked by **W**

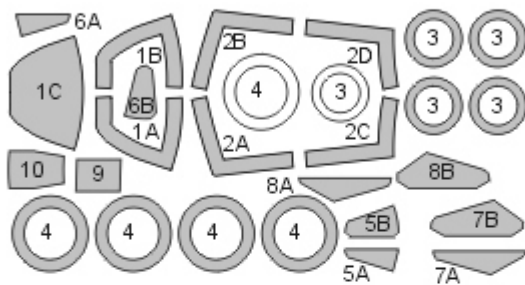

white - spare parts

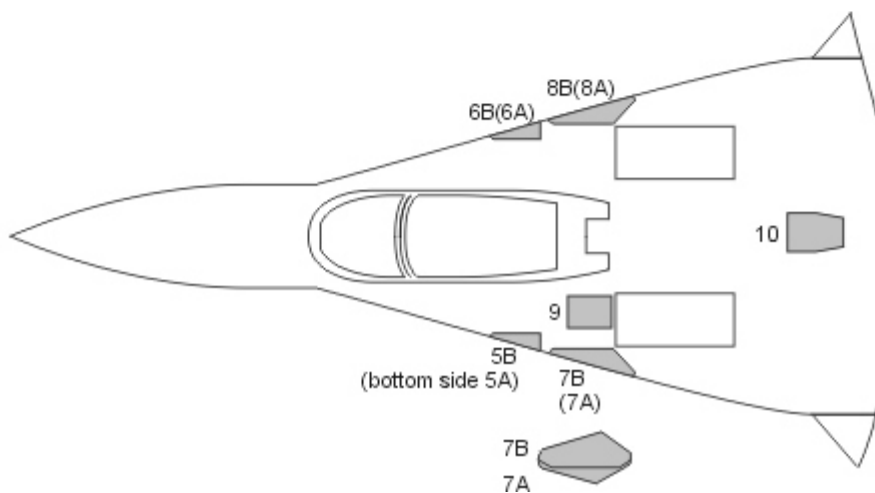
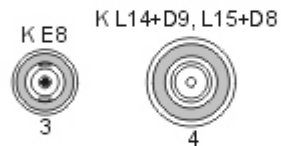
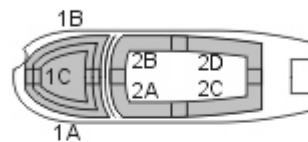



MiG-29 Fulcrum-A 9-12 Late Type ADVANCED kabuki masks

for G.W.H No. L7212 kit

<http://mek.kosmo.cz/newware>

INCLUDES ALSO WINDOWS
SEAL MASKS

tom.nwkits@seznam.cz

Important:

Let the sprayed color dry before applying masks. Remove masks very carefully after painting.

Where the mask is divided into A and B parts, first apply part A, next part B.

The set does not include masks for all areas, so mask the rest with masking tape or liquid mask.

K kit part

^ start placing the mask from this point

Placing wet masks on wet surface is recommended, except those marked by **W**

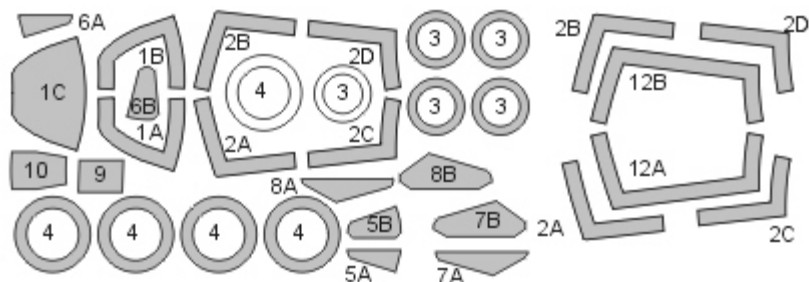

white - spare parts

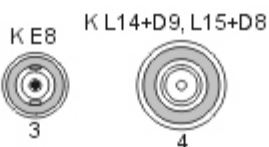

STEP 1 paint interior color

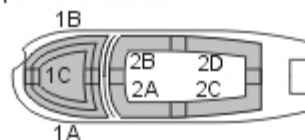

STEP 2 paint seal color

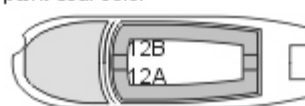

seal thickness 0,4 mm

STEP 3 paint camouflage color

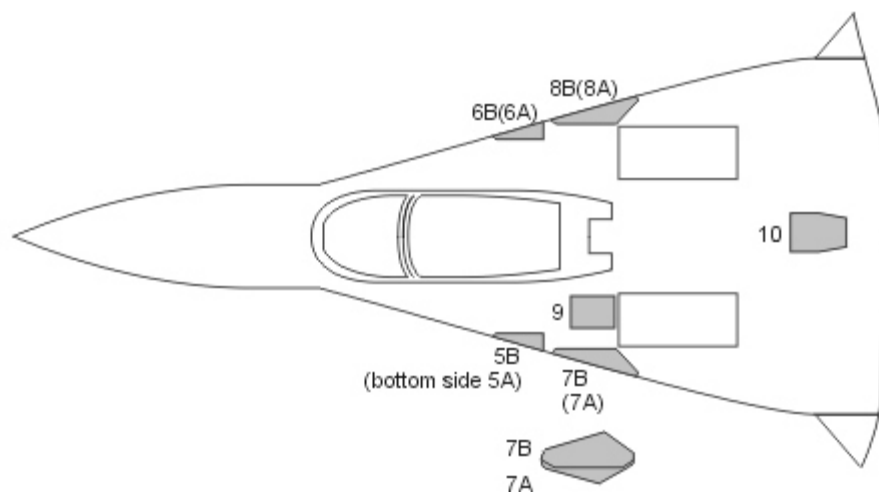
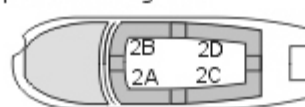



MiG-29 Fulcrum-A 9-12 Late Type EXPERT kabuki masks

for G.W.H No. L7212 kit

<http://mek.kosmo.cz/newware>

INCLUDES ALSO WINDOWS
SEAL AND INNER SIDE MASKS

tom.nwkits@seznam.cz

Important:

Let the sprayed color dry before applying masks. Remove masks very carefully after painting.
Where the mask is divided into A and B parts, first apply part A, next part B.
The set does not include masks for all areas, so mask the rest with masking tape or liquid mask.

K kit part

^ start placing the mask from this point

Placing wet masks on wet surface is recommended, except those marked by **W**

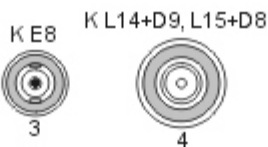
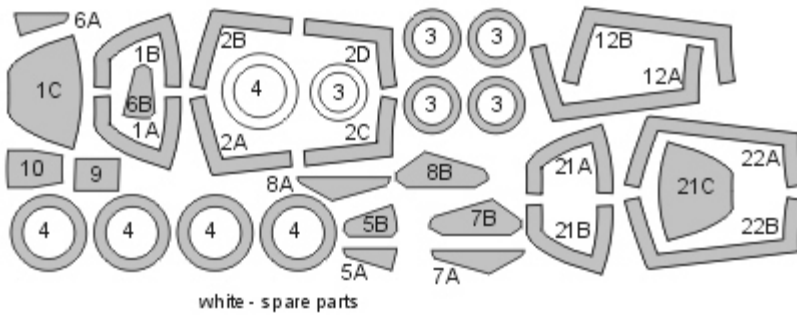

STEP 1 exterior view
mask interior, paint interior color

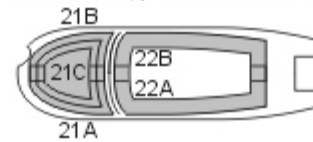

STEP 2
mask exterior, paint seal color

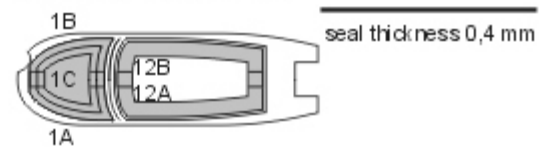

STEP 3
mask exterior, paint camouflage color

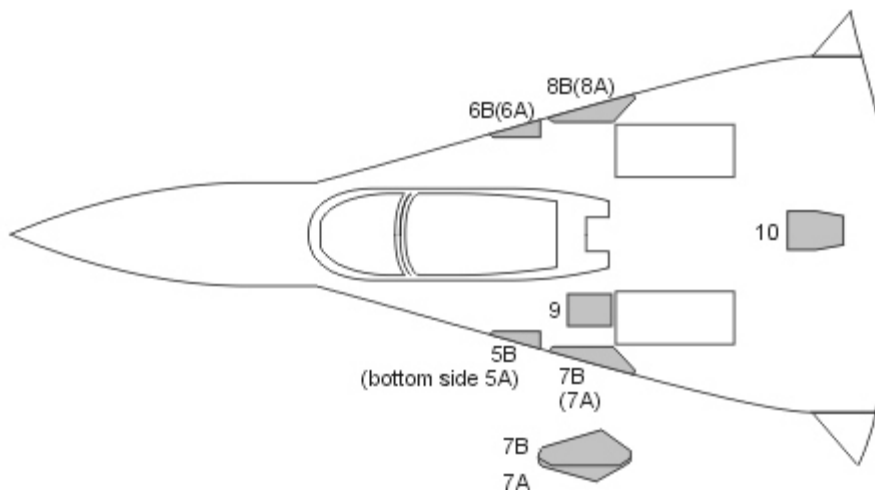
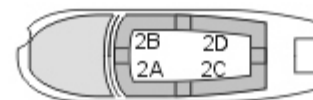



F/A-18A, F/A-18C Hornet BASIC kabuki masks

for Academy No. 12520, 12534, 12564 and other kits

<http://mek.kosmo.cz/newware>

tom.nwkits@seznam.cz

Important:

Let the sprayed color dry before applying masks. Remove masks very carefully after painting.

Where the mask is divided into A and B parts, first apply part A, next part B.

The set does not include masks for all areas, so mask the rest with masking tape or liquid mask.

K kit part

^ start placing the mask from this point

Placing wet masks on wet surface is recommended, except those marked by **W**

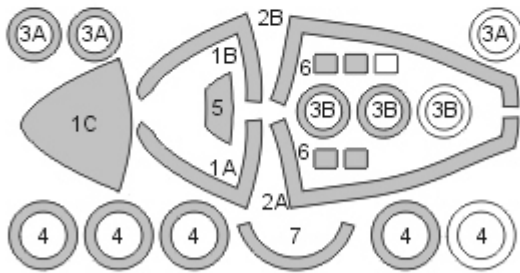

white - spare parts

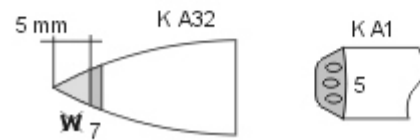
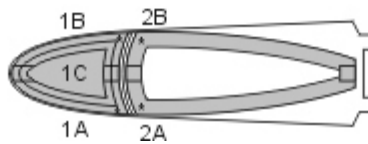



F/A-18A, F/A-18C Hornet EXPERT kabuki masks
for Academy No. 12520, 12534, 12564 and other kits
<http://mek.kosmo.cz/newware>

INCLUDES ALSO WINDOWS
INNER SIDE MASKS

tom.nwkits@seznam.cz

Important:

Let the sprayed color dry before applying masks. Remove masks very carefully after painting.
Where the mask is divided into A and B parts, first apply part A, next part B.
The set does not include masks for all areas, so mask the rest with masking tape or liquid mask.

K kit part

^ start placing the mask from this point

Placing wet masks on wet surface is recommended, except those marked by **W**

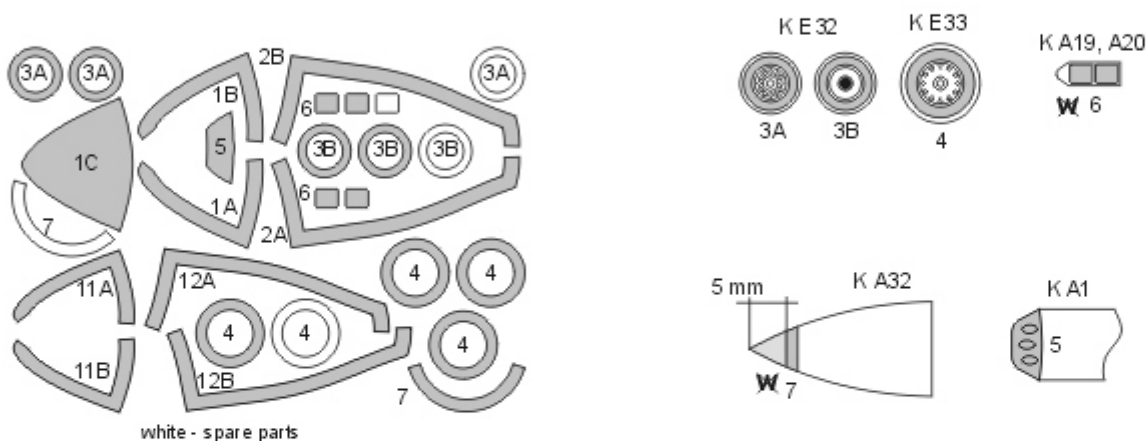

STEP 1 - exterior view

mask interior, paint interior color

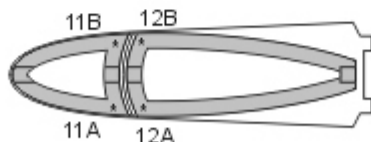

STEP 2

mask exterior, paint camouflage color

