



NEW WARE NEWSLETTER

NEW MASKS AUGUST 2023

NWAM1130 1/48 Mistel 1 BASIC kabuki masks	ICM
NWAM1131 1/48 Mistel 1 EXPERT kabuki masks	ICM
NWAM1132 1/48 de Havilland Vampire FB.5/ FB.9 BASIC kabuki masks	Airfix
NWAM1133 1/48 de Havilland Vampire FB.5/ FB.9 EXPERT kabuki masks	Airfix
NWAM1134 1/72 AC-130J Ghostri der BASIC kabuki masks	Zvezda
NWAM1135 1/72 AC-130J Ghostri der ADVANCED kabuki masks	Zvezda
NWAM1136 1/72 AC-130J Ghostri der EXPERT kabuki masks	Zvezda



Mistel 1 BASIC kabuki masks

for ICM 48100 kit

<http://mek.kosmo.cz/newware>

tom.nwkits@seznam.cz

Important:

Let the sprayed color dry before applying masks. Remove masks very carefully after painting.
 Where the mask is divided into A and B parts, first apply part A, next part B.
 The set does not include masks for all areas, so mask the rest with masking tape or liquid mask.

K kit part

^ start placing the mask from this point

Placing wet masks on wet surface is recommended, except those marked by **W**

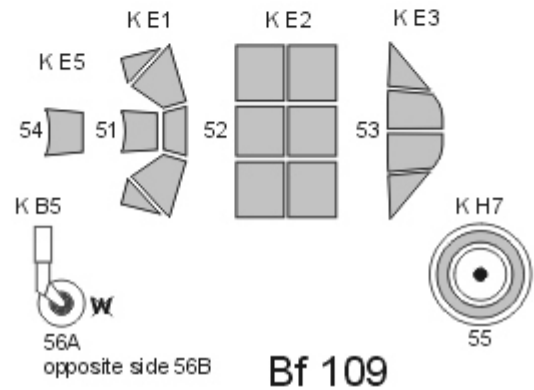
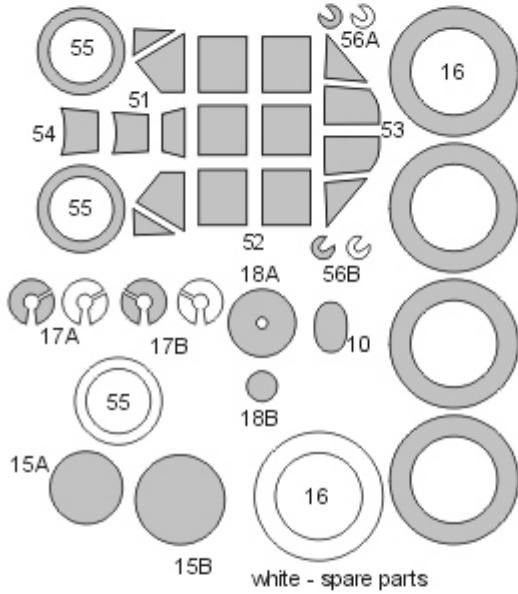

Bf 109

Ju 88

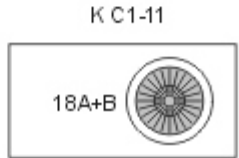
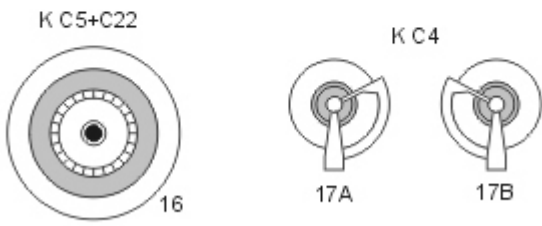



Mistel 1 EXPERT kabuki masks

for ICM 48100 kit

<http://mek.kosmo.cz/newware>

tom.nwkits@seznam.cz

Important:

Let the sprayed color dry before applying masks. Remove masks very carefully after painting.
 Where the mask is divided into A and B parts, first apply part A, next part B.
 The set does not include masks for all areas, so mask the rest with masking tape or liquid mask.

K kit part

^ start placing the mask from this point

Placing wet masks on wet surface is recommended, except those marked by **W**

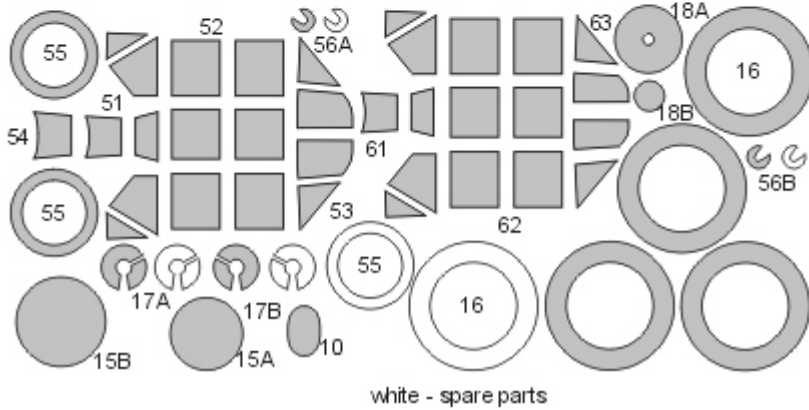

Bf 109

STEP 1

mask interior, paint interior color

K B5



56A
opposite side 56B

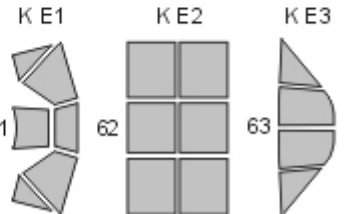

STEP 2

mask exterior, paint camouflage color



55

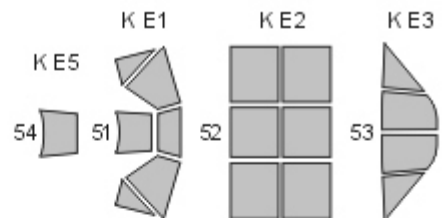

Ju 88

K C5+C22

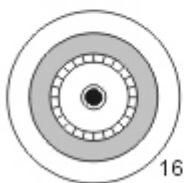

K C4



K F1

K F20



10

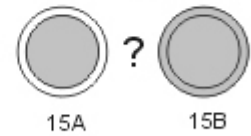

K C1-11





de Havilland Vampire FB.5/FB.9 BASIC kabuki masks

for Airfix A06108 kits

<http://mek.kosmo.cz/newware>

tom.nwkits@seznam.cz

Important:

Let the sprayed color dry before applying masks. Remove masks very carefully after painting.

Where the mask is divided into A and B parts, first apply part A, next part B.

The set does not include masks for all areas, so mask the rest with masking tape or liquid mask.

K kit part

^ start placing the mask from this point

Placing wet masks on wet surface is recommended, except those marked by **W**

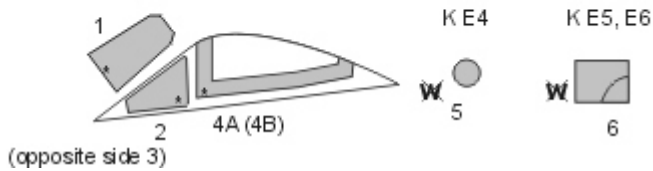
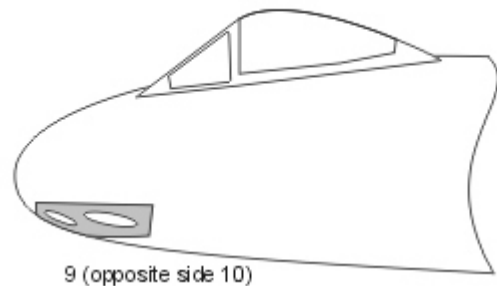
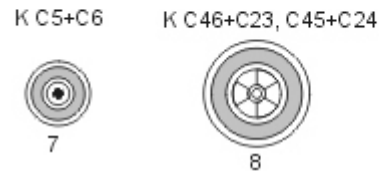
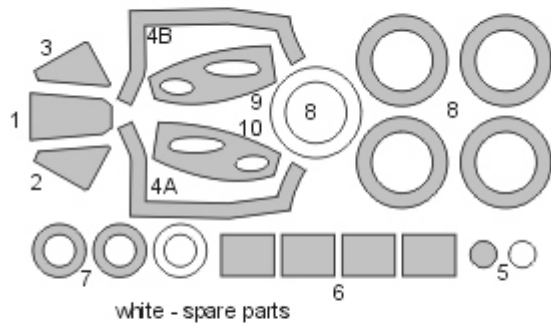

NWAM1133

1/48 scale



de Havilland Vampire FB.5/FB.9 EXPERT kabuki masks
for Airfix A06108 kits
<http://mek.kosmo.cz/newware>

INCLUDES ALSO WINDOWS
INNER SIDE MASKS

tom.nwkits@seznam.cz

Important:

Let the sprayed color dry before applying masks. Remove masks very carefully after painting.
Where the mask is divided into A and B parts, first apply part A, next part B.
The set does not include masks for all areas, so mask the rest with masking tape or liquid mask.

K kit part

^ start placing the mask from this point

Placing wet masks on wet surface is recommended, except those marked by **W**

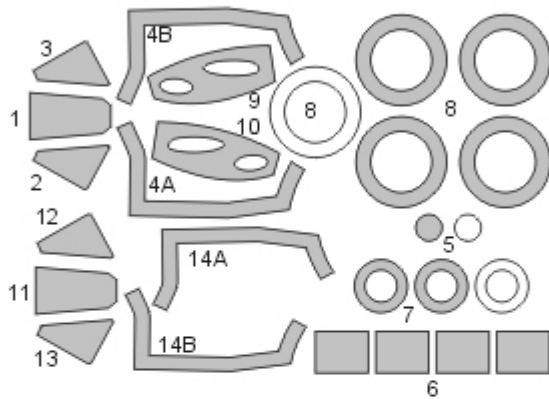

white - spare parts

K C5+C6



7

K C46+C23, C45+C24



8

KE4



5

KE5, E6



6

STEP 1 (exterior view)
mask interior, paint interior color

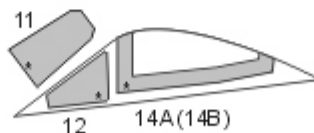

(opposite side 13)

STEP 2
mask exterior, paint camouflage color

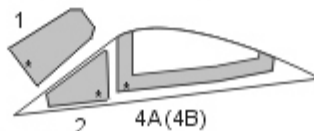

(opposite side 3)

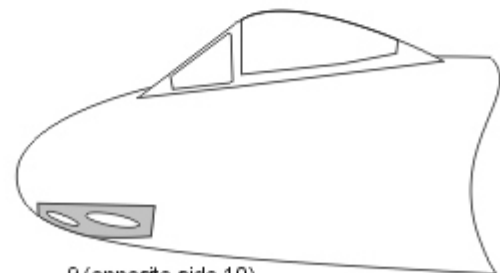

9 (opposite side 10)



AC-130J Ghost rider BASIC kabuki masks

for Zvezda 7826 kit

<http://mek.kosmo.cz/newware>

tom.nwkits@seznam.cz

Important:

Let the sprayed color dry before applying masks. Remove masks very carefully after painting.

Where the mask is divided into A and B parts, first apply part A, next part B.

The set does not include masks for all areas, so mask the rest with masking tape or liquid mask.

K kit part

^ start placing the mask from this point

Placing wet masks on wet surface is recommended, except those marked by **W**

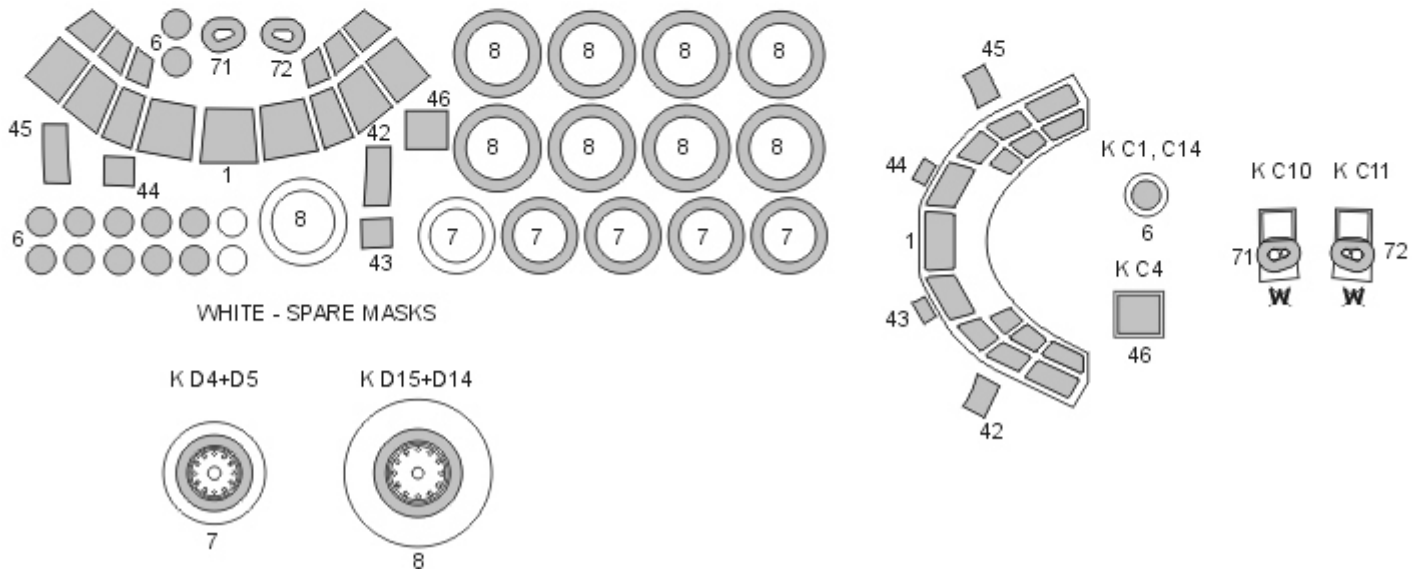



AC-130J Ghost rider EXPERT kabuki masks
for Zvezda 7826 kit
<http://mek.kosmo.cz/newware>

INCLUDES ALSO WINDOWS
INNER SIDE AND SEAL MASKS
AND CAMOUFLAGE MASKS

tom.nwkits@seznam.cz

Important:

Let the sprayed color dry before applying masks. Remove masks very carefully after painting.
Where the mask is divided into A and B parts, first apply part A, next part B.
The set does not include masks for all areas, so mask the rest with masking tape or liquid mask.

K kit part

^ start placing the mask from this point

Placing wet masks on wet surface is recommended, except those marked by **W**

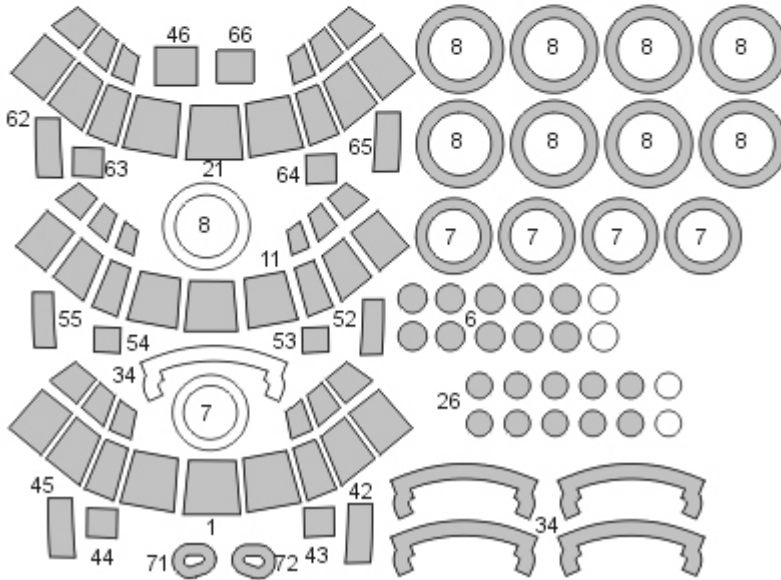

WHITE - SPARE MASKS

STEP 1 - exterior view
mask interior, paint interior color

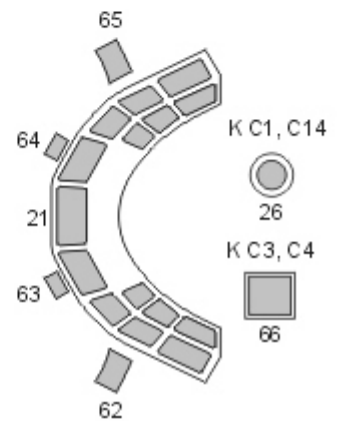

STEP 2
mask exterior, paint seal color

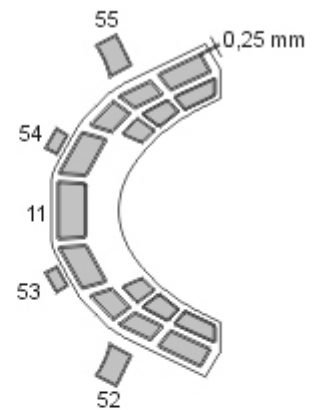

STEP 3
mask exterior, paint camouflage color

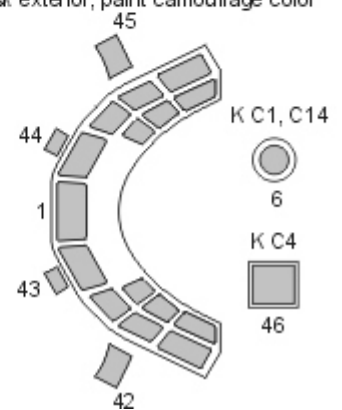

K D4+D5



K D15+D14

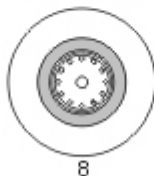

K C10 K C11

