



# NEW WARE NEWSLETTER

## NEW MASKS JUNE 2023

NWAM1107 1/48 Mi-17 Hip BASIC kabuki masks	AMK/Annetra
NWAM1108 1/48 Mi-17 Hip EXPERT kabuki masks	AMK/Annetra
NWAM1109 1/48 He 111 H-8 Paravane BASIC kabuki masks	ICM
NWAM1110 1/48 He 111 H-8 Paravane EXPERT kabuki masks	ICM
NWAM1111 1/48 He 111 H-8 Paravane NATIONAL INSIGNIA kabuki masks	ICM
NWAM1112 1/48 Republic F-84G Thunderjet BASIC kabuki masks	Tamiya
NWAM1113 1/48 Republic F-84G Thunderjet ADVANCED kabuki masks	Tamiya
NWAM1114 1/48 Republic F-84G Thunderjet EXPERT kabuki masks	Tamiya
NWAM1115 1/48 Do 217 J-1/2 BASIC kabuki masks	Revell
NWAM1116 1/48 Do 217 J-1/2 ADVANCED kabuki masks	Revell
NWAM1117 1/48 Do 217 J-1/2 MARKING kabuki masks	Revell
NWAM1118 1/48 F-16D Block 30/40/50 BASIC kabuki masks	Kinetic
NWAM1119 1/48 F-16D Block 30/40/50 ADVANCED kabuki masks	Kinetic
NWAM1120 1/48 F-16D Block 30/40/50 EXPERT kabuki masks	Kinetic
NWAM1121 1/48 F-16 F110 engine EXHAUST NOZZLE kabuki masks	Kinetic







## He 111 H-8 Paravane BASIC kabuki masks

for ICM kit 48267

<http://mek.kosmo.cz/newware>

tom.nwkits@seznam.cz

USE ALSO NWAM1111 HE 111H-8 Paravane NATIONAL INSIGNIA KABUKI MASKS

### Important:

Let the sprayed color dry before applying masks. Remove masks very carefully after painting.

Where the mask is divided into A and B parts, first apply part A, next part B.

The set does not include masks for all areas, so mask the rest with masking tape or liquid mask.

K kit part

\* start placing the mask from this point

Placing wet masks on wet surface is recommended, except those marked by **W**

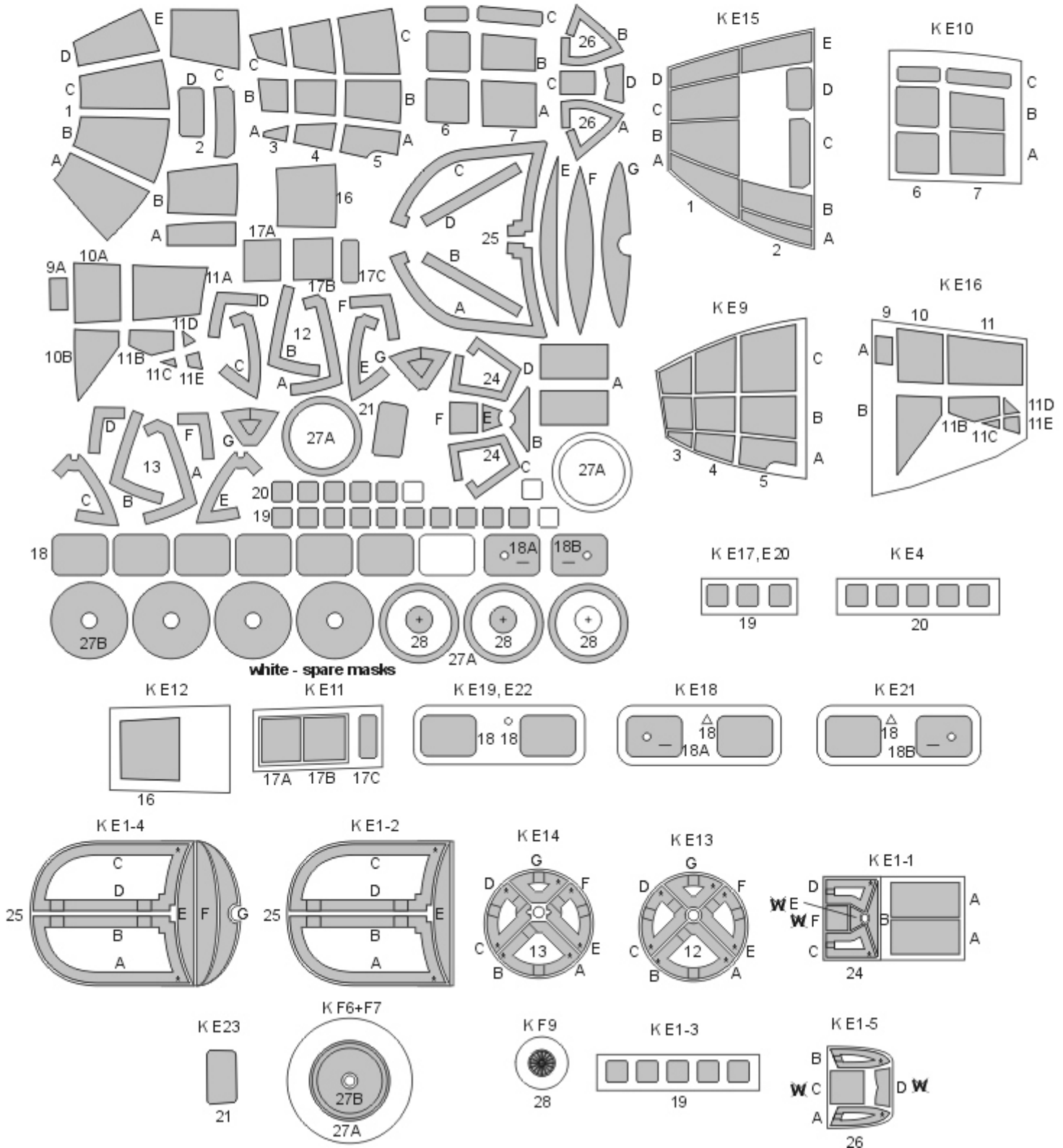



He 111 H-8 Paravane EXPERT kabuki masks  
for ICM kit 48267

INCLUDES ALSO  
WINDOWS INNER SIDE MASKS

<http://mek.kosmo.cz/newware>

tom.nwkits@seznam.cz

USE ALSO NWAM1111 HE 111H-8 Paravane NATIONAL INSIGNIA KABUKI MASKS

**Important:**

Let the sprayed color dry before applying masks. Remove masks very carefully after painting.  
Where the mask is divided into A and B parts, first apply part A, next part B.  
The set does not include masks for all areas, so mask the rest with masking tape or liquid mask.

K kit part

\* start placing the mask from this point

Placing wet masks on wet surface is recommended, except those marked by **W**

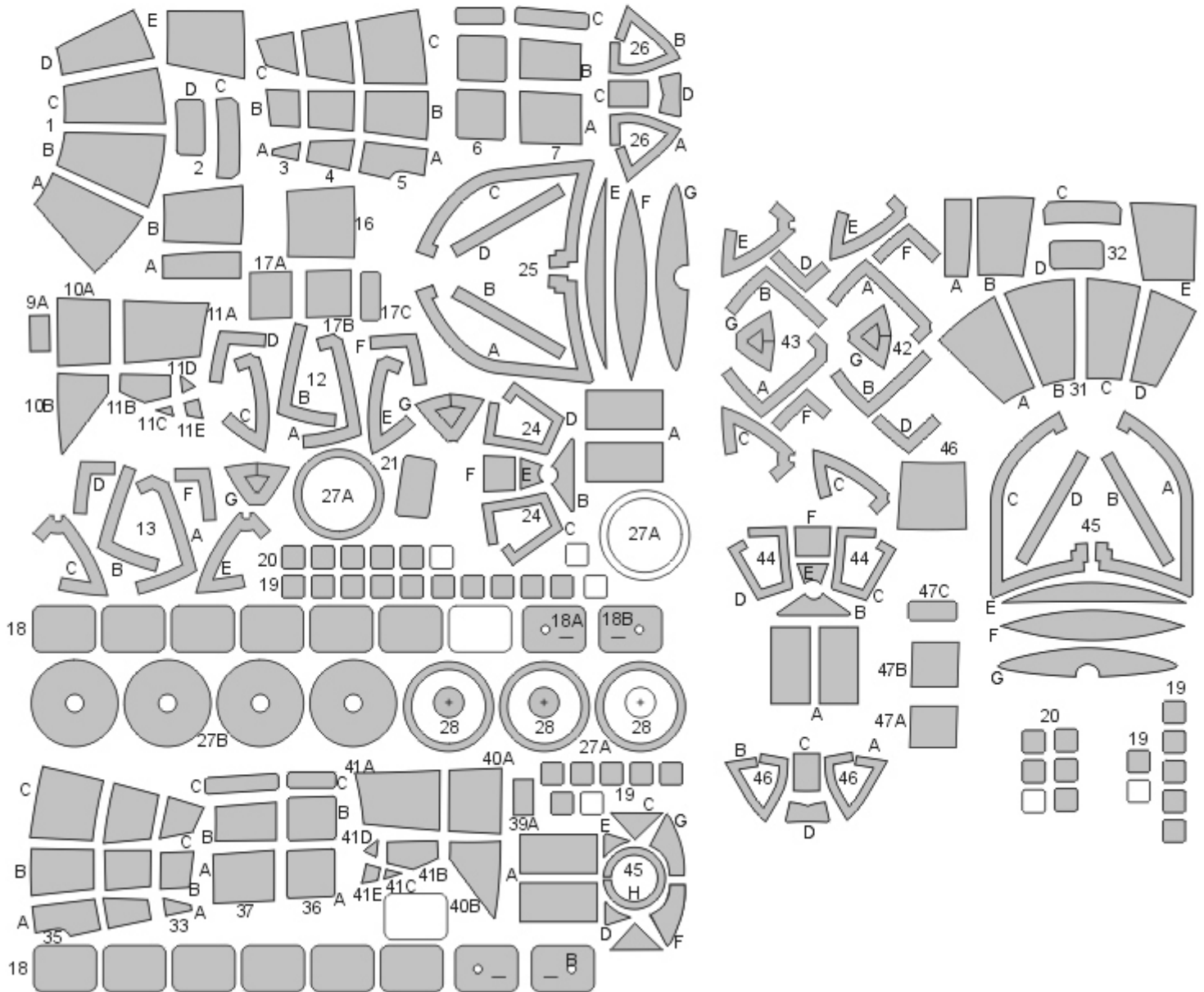

white - spare masks

STEP 1 - exterior view  
mask interior, paint interior color

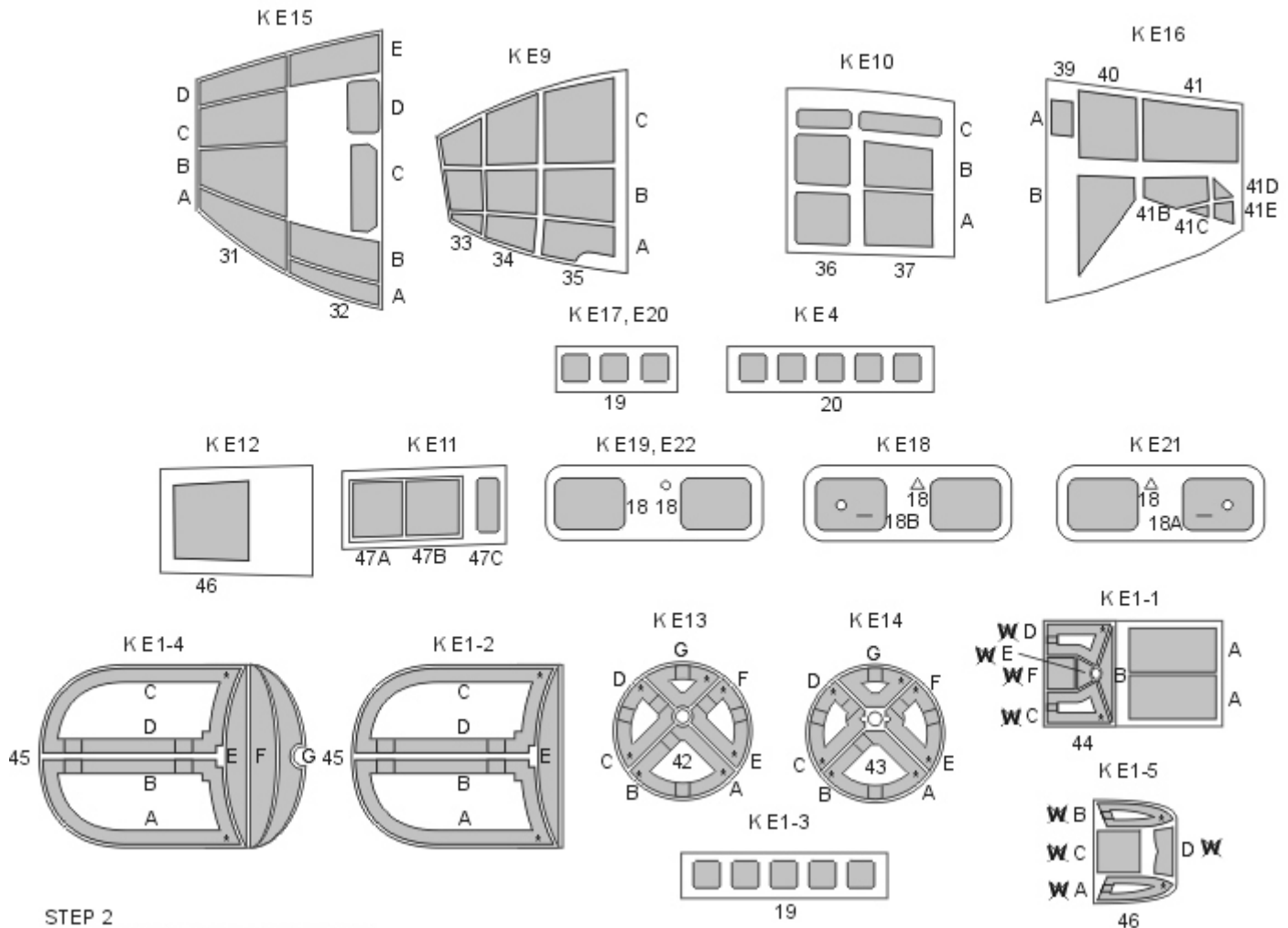

STEP 2  
mask exterior, paint camouflage color

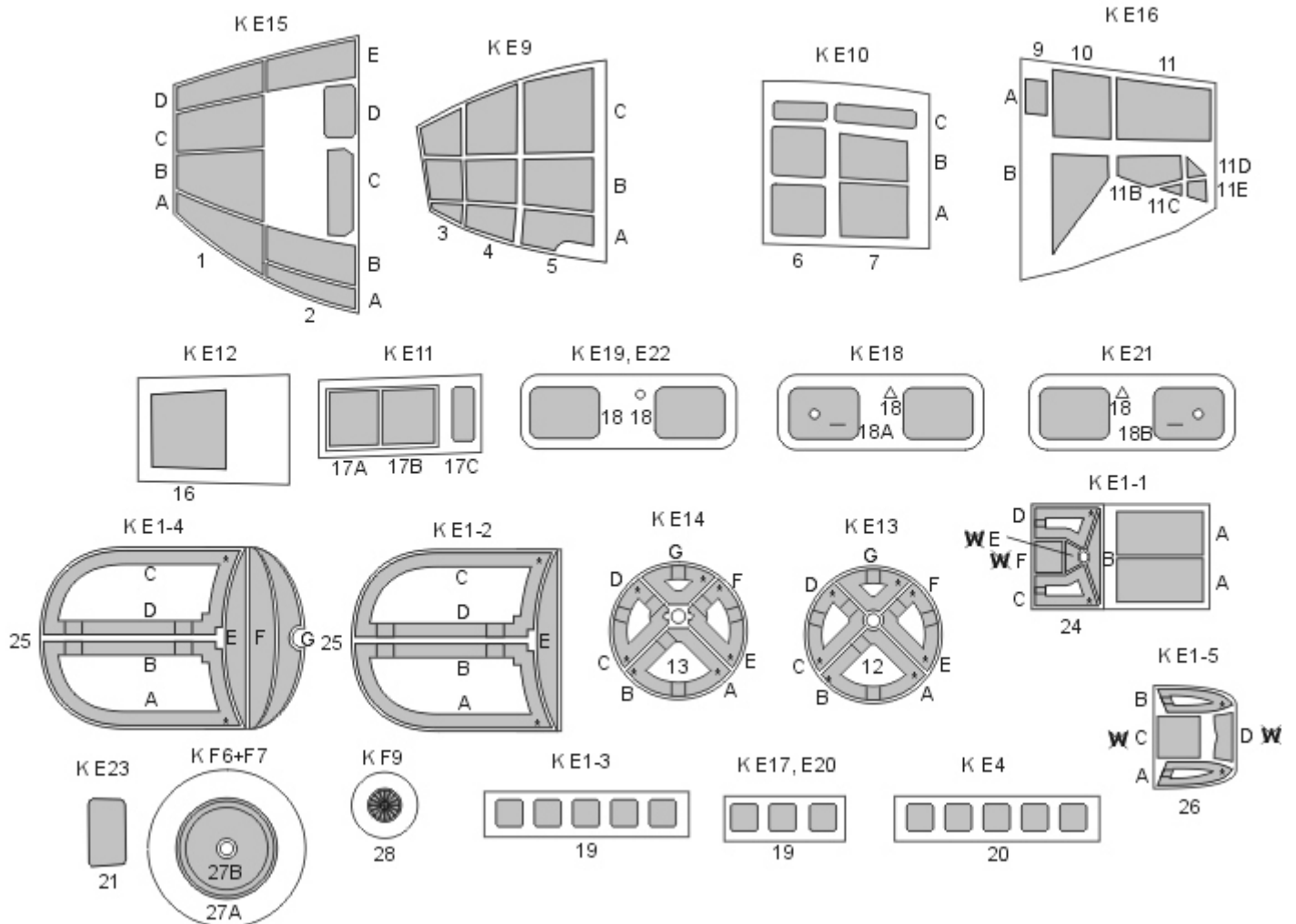



**Important:**

Let the sprayed color dry before applying masks. Remove masks very carefully after painting.  
 Use masks for replacement of decals with corresponding numbers. For transporting masks from the masking sheet to the model use transport foil.  
 The set does not include masks for all areas, so mask the rest with masking tape or liquid mask.

K kit part

\* start placing the mask from this point

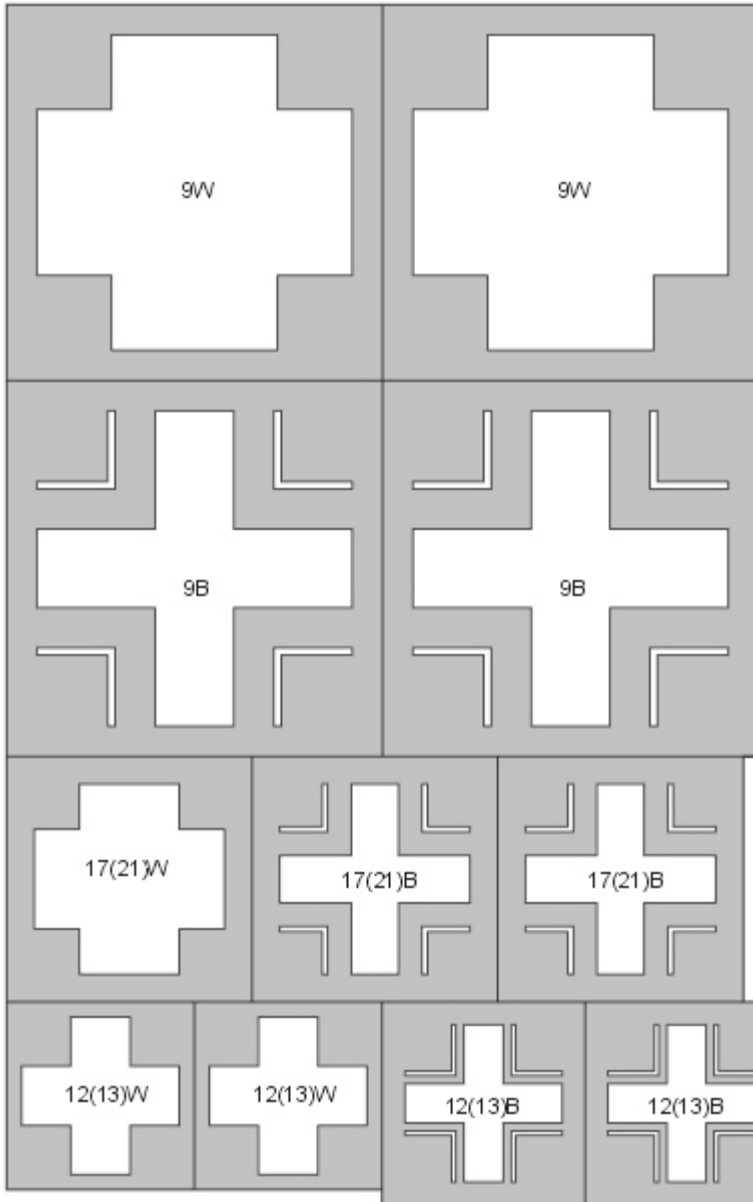

masks numbers are corresponding to decals numbers

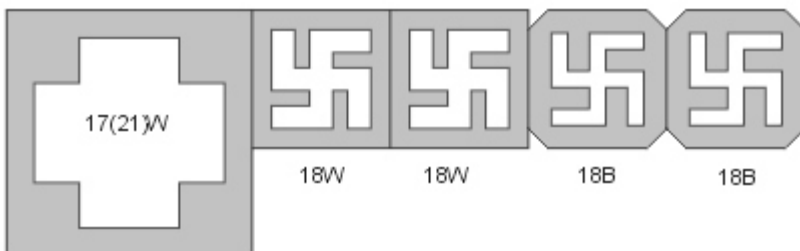

1. Apply mask 18W
2. Paint black
3. Apply mask 18B
4. Paint white

1. Apply mask 18W
2. Paint white
3. Apply mask 18B
4. Paint black

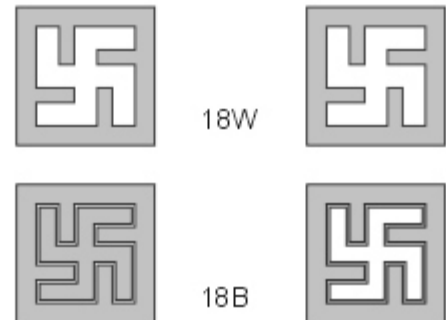

Place mask nnW  
 paint white  
 place mask nnB  
 paint black

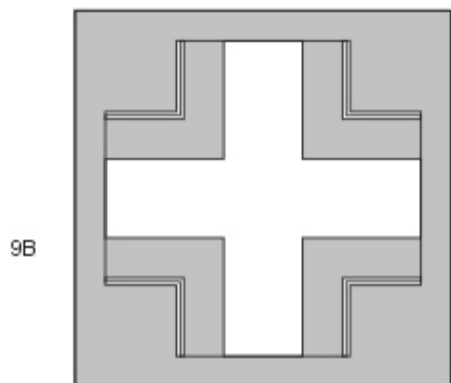
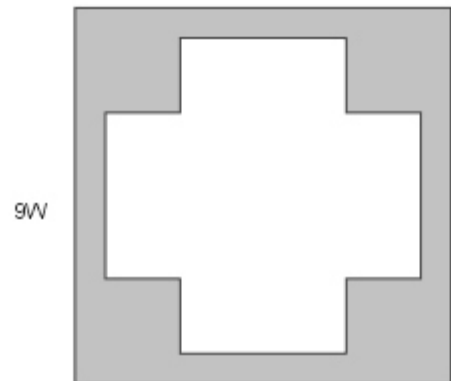



Republic F-84G Thunderjet BASIC kabuki masks  
for Tamiya 61060, 61060F, 61077 kits  
<http://mek.kosmo.cz/newware>

tom.nwkits@seznam.cz

**Important:**

Let the sprayed color dry before applying masks. Remove masks very carefully after painting.  
Where the mask is divided into A and B parts, first apply part A, next part B.  
The set does not include masks for all areas, so mask the rest with masking tape or liquid mask.  
K kit part  
^ start placing the mask from this point  
Placing wet masks on wet surface is recommended, except those marked by **W**

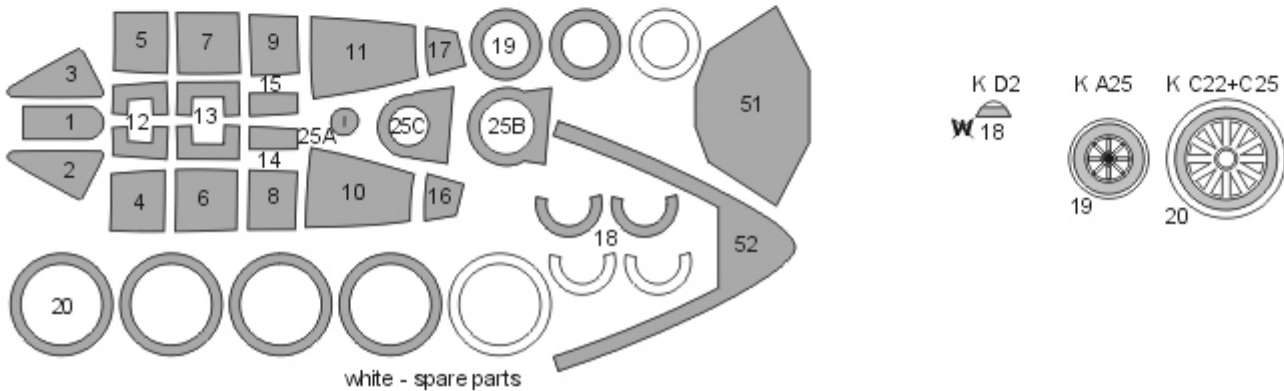

paint olive drab

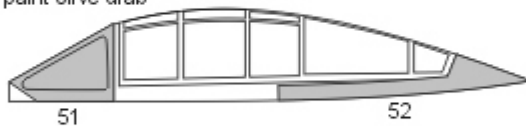

STEP 1  
paint white

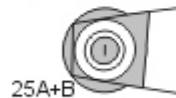

STEP 2  
paint bare-metal silver

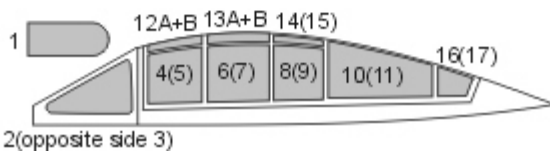
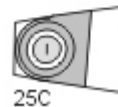



# NWAM1113



Republic F-84G Thunderjet **ADVANCED** kabuki masks

for Tamiya 61060, 61060F, 61077 kits

<http://mek.kosmo.cz/newware>

INCLUDES ALSO  
WINDOWS FRAME AND SEAL MASKS

1/48 scale

tom.nwkits@seznam.cz

### Important:

Let the sprayed color dry before applying masks. Remove masks very carefully after painting.

Where the mask is divided into A and B parts, first apply part A, next part B.

The set does not include masks for all areas, so mask the rest with masking tape or liquid mask.

K kit part

^ start placing the mask from this point

Placing wet masks on wet surface is recommended, except those marked by **W**

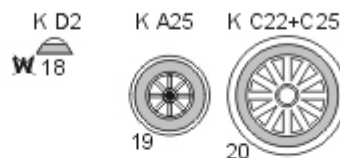
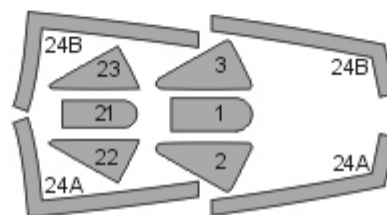
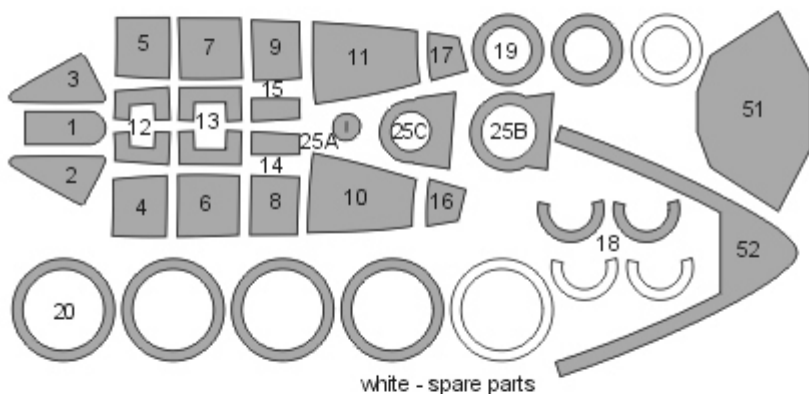

### STEP 1

paint interior color, next paint white

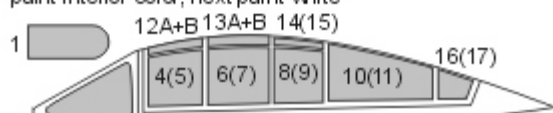

2(opposite side 3)

### STEP 2

paint black

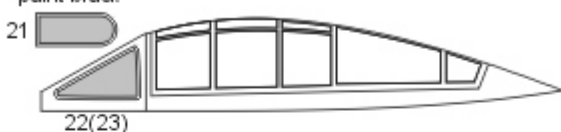

### STEP 3

paint bare-metal silver

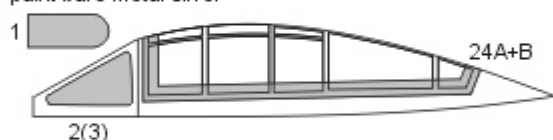

2(3)

paint olive drab

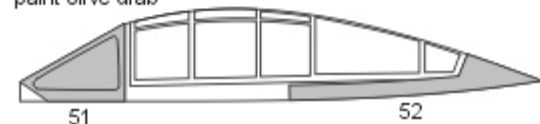

51

52

### STEP 1

paint white



### STEP 2

paint bare-metal silver

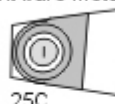

25C



Republic F-84G Thunderjet EXPERT kabuki masks  
for Tamiya 61060, 61060F, 61077 kits  
<http://mek.kosmo.cz/newware>

INCLUDES ALSO  
WINDOWS FRAME AND SEAL  
AND INNER SIDE MASKS

tom.nwkits@seznam.cz

**Important:**

Let the sprayed color dry before applying masks. Remove masks very carefully after painting.  
Where the mask is divided into A and B parts, first apply part A, next part B.  
The set does not include masks for all areas, so mask the rest with masking tape or liquid mask.

K kit part

^ start placing the mask from this point

Placing wet masks on wet surface is recommended, except those marked by **W**

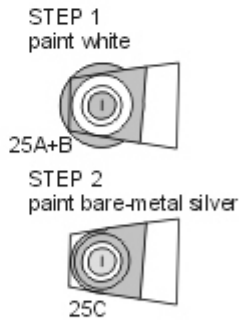
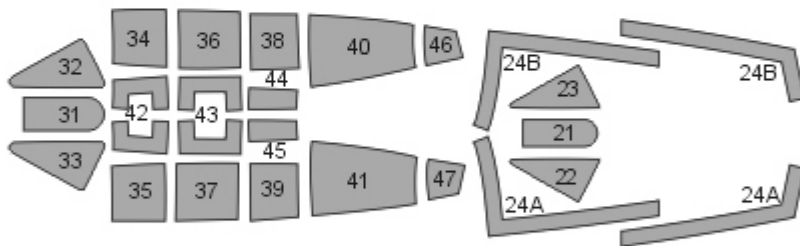
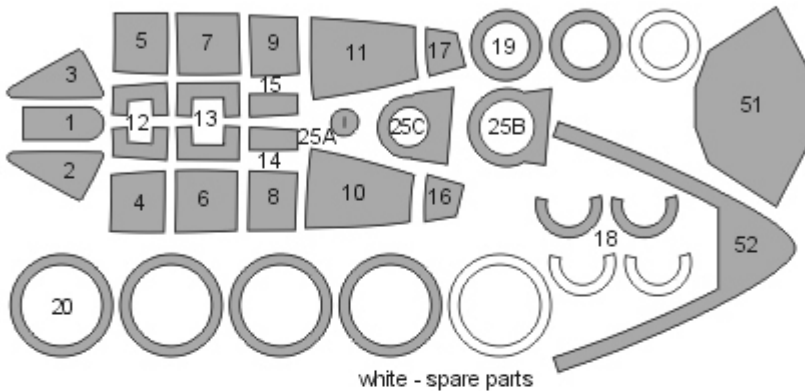

**STEP 1 (exterior view)**

mask interior, paint interior color

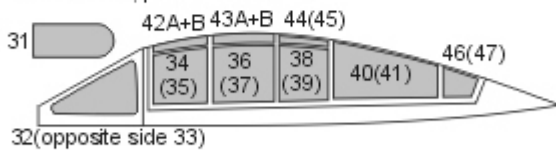

**STEP 2**

mask exterior, paint black

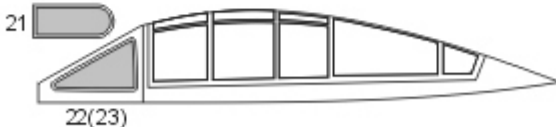

**STEP 3**

mask exterior, paint white

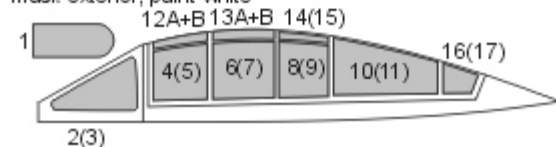

**STEP 4**

mask exterior, paint bare-metal silver

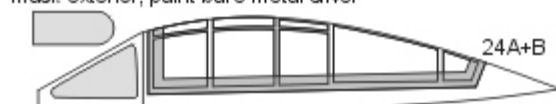

paint olive drab

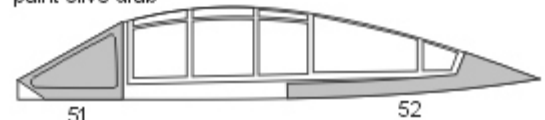



Do 217J-1/2 BASIC kabuki masks

for Revell 03814 kit

<http://mek.kosmo.cz/newware>

tom.nwkits@seznam.cz

USE ALSO NWAM1117 Do 217J-1/2 MARKING MASKS

**Important:**

Let the sprayed color dry before applying masks. Remove masks very carefully after painting.

Where the mask is divided into A and B parts, first apply part A, next part B.

The set does not include masks for all areas, so mask the rest with masking tape or liquid mask.

K kit part

^ start placing the mask from this point

Placing wet masks on wet surface is recommended, except those marked by **W**

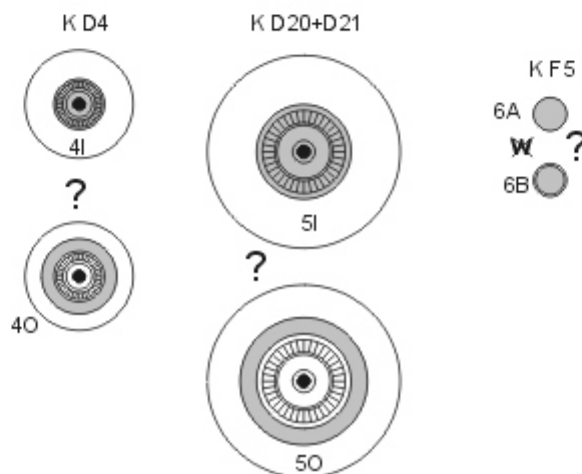
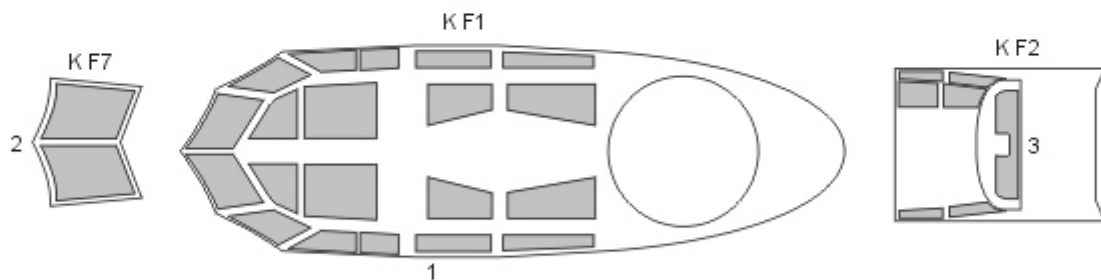
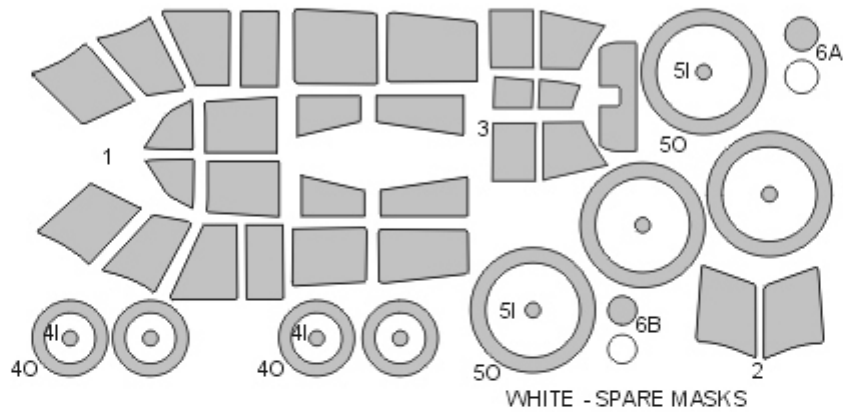

# NWAM1116

1/48 scale



Do 217J-1/2 EXPERT kabuki masks

for Revell 03814 kit

<http://mek.kosmo.cz/newware>

INCLUDES AIRCRAFT CANOPY  
INNER SIDE MASKS

tom.nwkits@seznam.cz

## USE ALSO NWAM1117 Do 217J-1/2 MARKING MASKS

### Important:

Let the sprayed color dry before applying masks. Remove masks very carefully after painting.

Where the mask is divided into A and B parts, first apply part A, next part B.

The set does not include masks for all areas, so mask the rest with masking tape or liquid mask.

K kit part

^ start placing the mask from this point

Placing wet masks on wet surface is recommended, except those marked by **W**

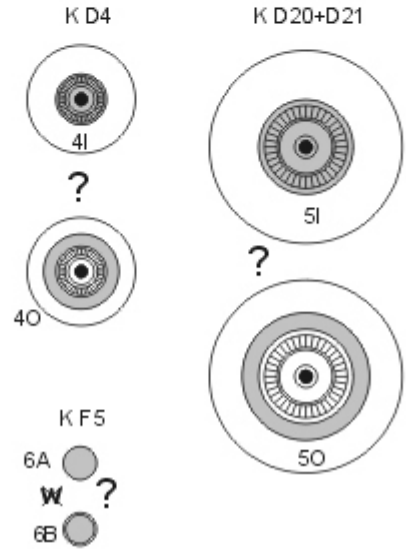
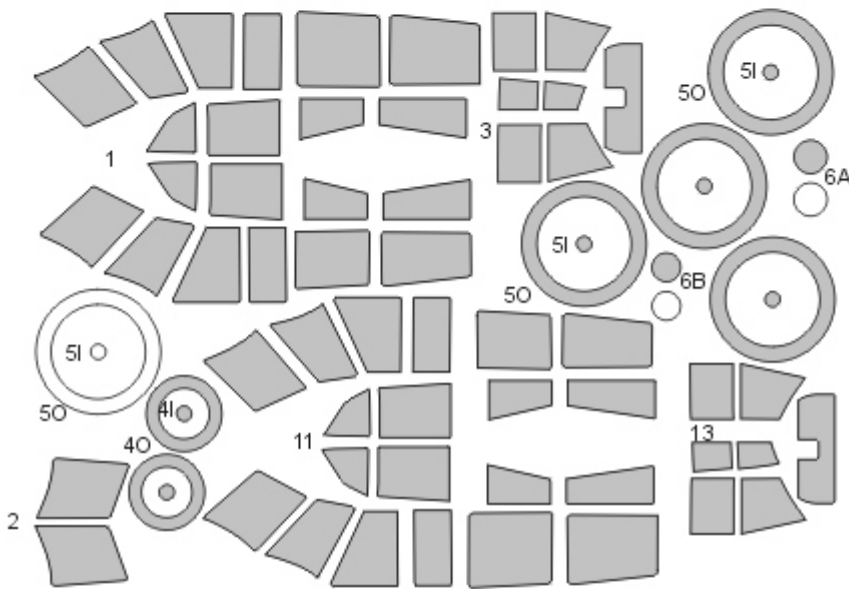

WHITE - SPARE MASKS

STEP 1 - exterior view  
mask interior, paint interior color

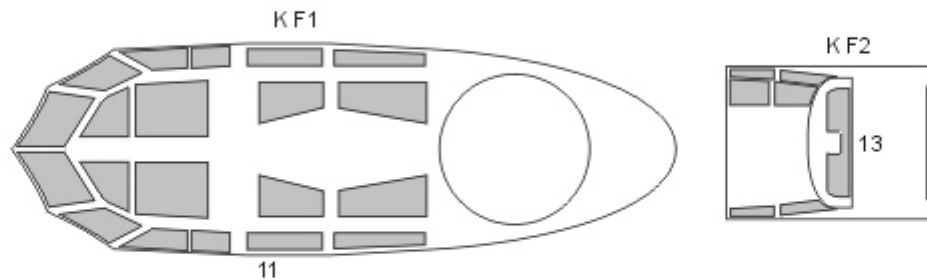

STEP 2  
mask exterior, paint camouflage color

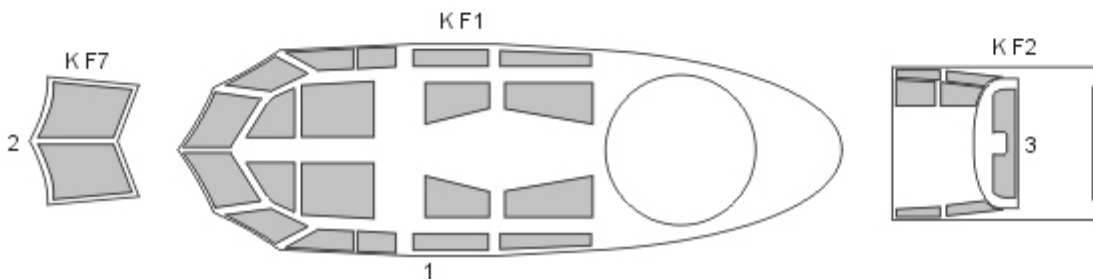



Do 217J-1/2 MARKING kabuki masks

for Revell 03814 kit

<http://mek.kosmo.cz/newware>

tom.nwkits@seznam.cz

**USE ALSO NWAM1115 OR NWAM1116 Do 217J-1/2 MASKS**

**Important:**

Let the sprayed color dry before applying masks. Remove masks very carefully after painting.  
 Use masks for replacement of decals with corresponding numbers. For transporting masks from the masking sheet to the model use transport foil.  
 The set does not include masks for all areas, so mask the rest with masking tape or liquid mask.

K kit part

\* start placing the mask from this point

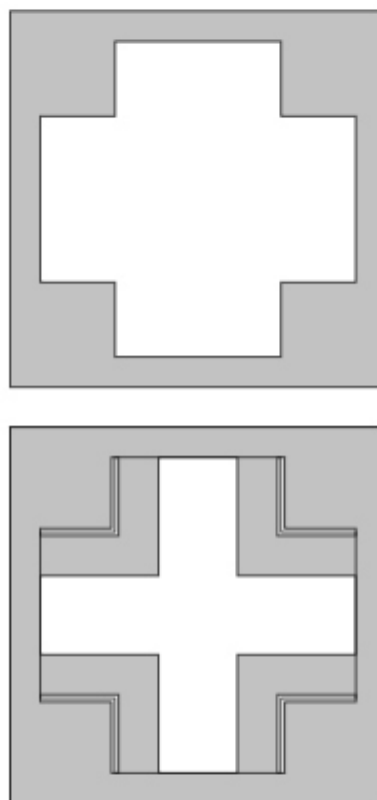
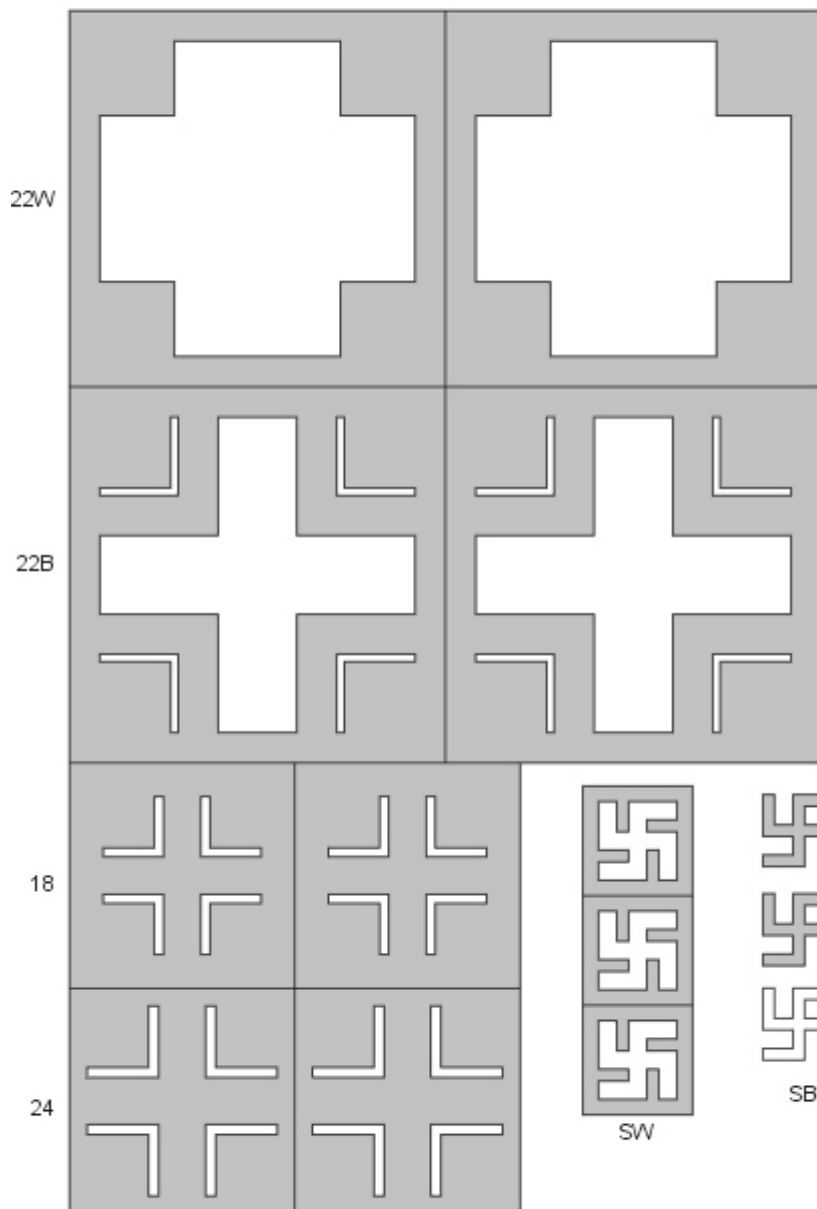

Place mask nnW  
 paint white  
 place mask nnB  
 paint black

masks numbers are corresponding to decals numbers

use transfer foil

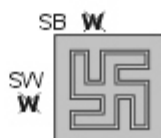

# NWAM1118

1/48 scale



F-16D Block 30/40/50 USAF BASIC kabuki masks

for Kinetic K48105 kit

<http://mek.kosmo.cz/newware>

tom.nwkits@seznam.cz

Use also NWAM1121 F110 engine exhaust nozzle kabuki masks

### Important:

Let the sprayed color dry before applying masks. Remove masks very carefully after painting.

Where the mask is divided into A and B parts, first apply part A, next part B.

The set does not include masks for all areas, so mask the rest with masking tape or liquid mask.

K kit part

\* start placing the mask from this point

Placing wet masks on wet surface is recommended, except those marked by **W**

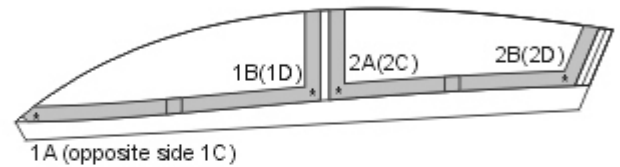
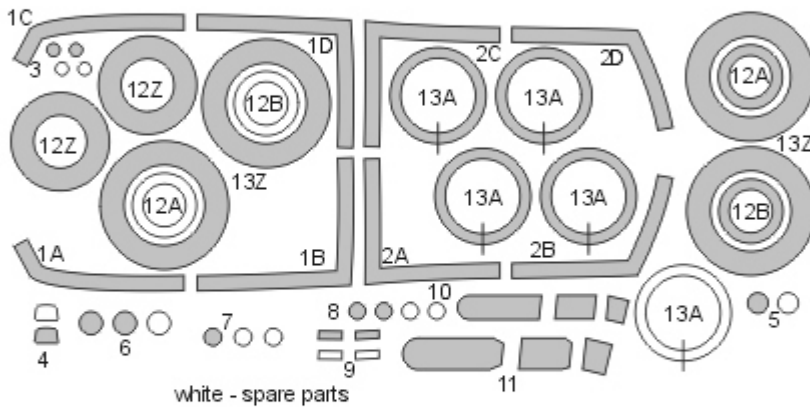

K D4+D8

K F26+F27, F19+F20

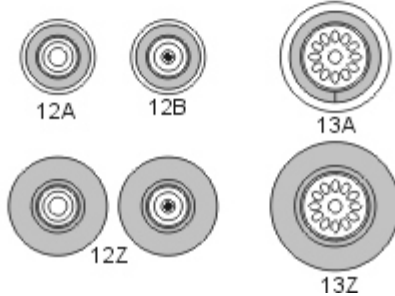

K G19+G22

STEP 1 - paint red



STEP 2 - paint camouflage color

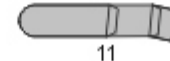

# NWAM1119



## F-16D Block 30/40/50 USAF ADVANCED kabuki masks

for Kinetic K48105 kit

<http://mek.kosmo.cz/newware>

INCLUDES ALSO WINDOWS  
SEAL AND CAMOUFLAGE  
MASKS **1/48 scale**

tom.nwkits@seznam.cz

### Use also NWAM1121 F110 engine exhaust nozzle kabuki masks

**Important:**

Let the sprayed color dry before applying masks. Remove masks very carefully after painting.  
Where the mask is divided into A and B parts, first apply part A, next part B.  
The set does not include masks for all areas, so mask the rest with masking tape or liquid mask.

K kit part

\* start placing the mask from this point

Placing wet masks on wet surface is recommended, except those marked by **W**

0,5 mm

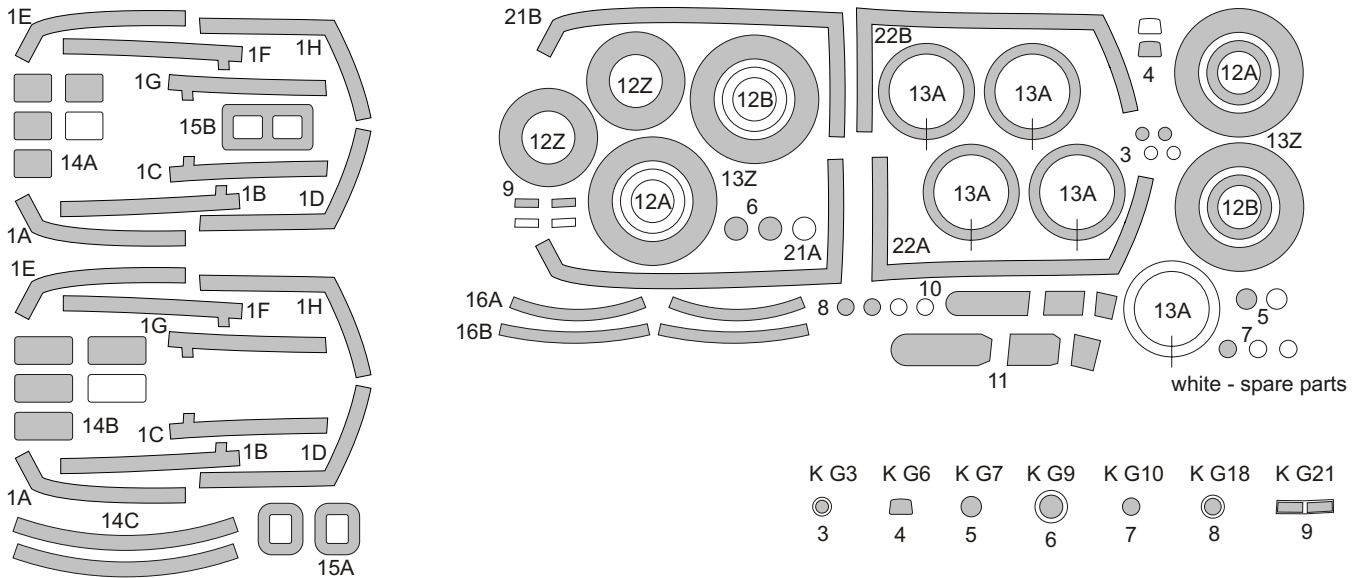

**STEP 1**  
paint interior color

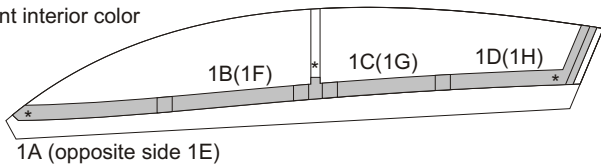

GBU-31  
paint olive  
mask  
paint gray



**STEP 2**  
paint black

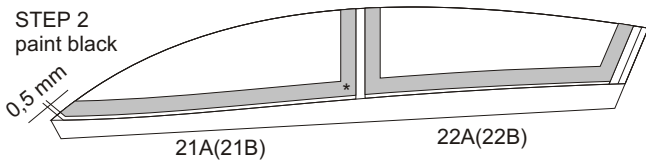

GBU-38

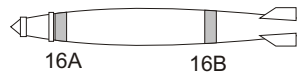

**STEP 3**  
paint camouflage color

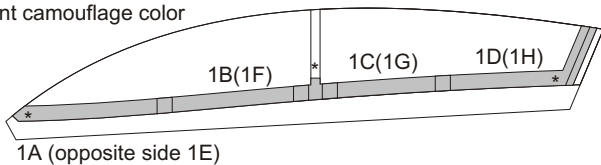

K G19+G22

**STEP 1 - paint red**

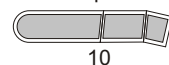

**STEP 2 - paint camouflage color**

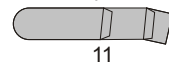

K D4+D8

K F26+F27, F19+F20

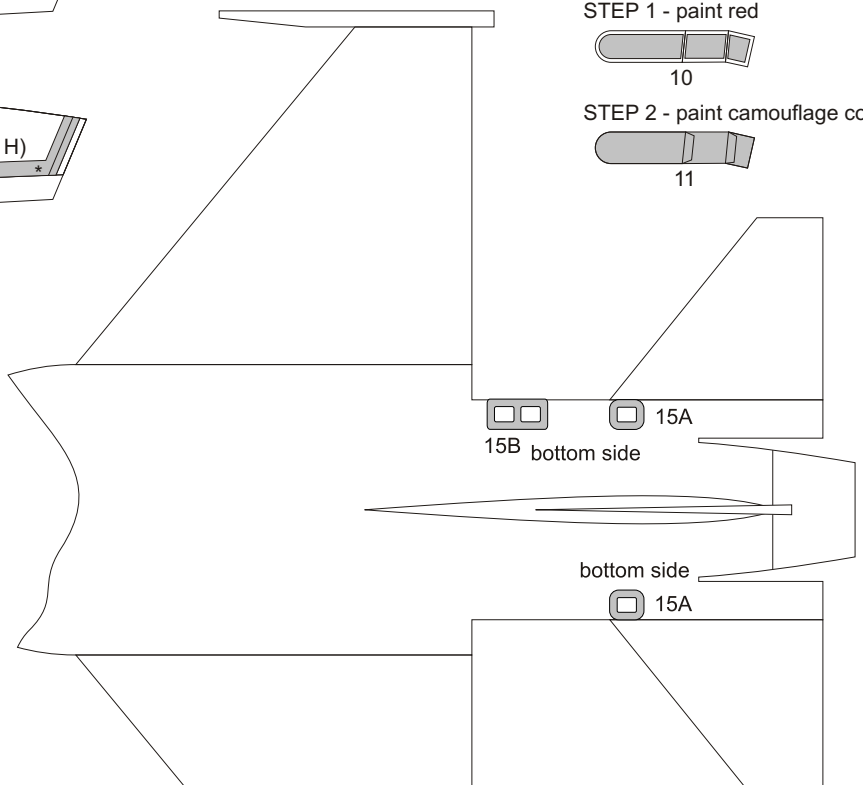
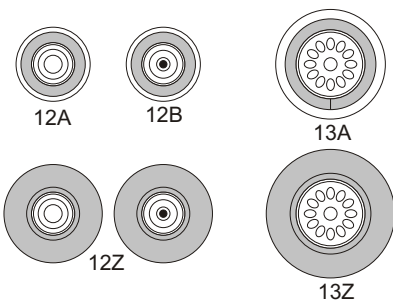



# NWAM1120

## F-16D Block 30/40/50 USAF EXPERT kabuki masks

### for Kinetic K48105 kit

<http://mek.kosmo.cz/newware>

INCLUDES ALSO WINDOWS  
SEAL AND INNER SIDE  
AND CAMOUFLAGE MASKS

1/48 scale

tom.nwkits@seznam.cz

### Use also NWAM1121 F110 engine exhaust nozzle kabuki masks

#### Important:

Let the sprayed color dry before applying masks. Remove masks very carefully after painting.  
Where the mask is divided into A and B parts, first apply part A, next part B.  
The set does not include masks for all areas, so mask the rest with masking tape or liquid mask.

K kit part

^ start placing the mask from this point

Placing wet masks on wet surface is recommended, except those marked by **W**

0,5 mm

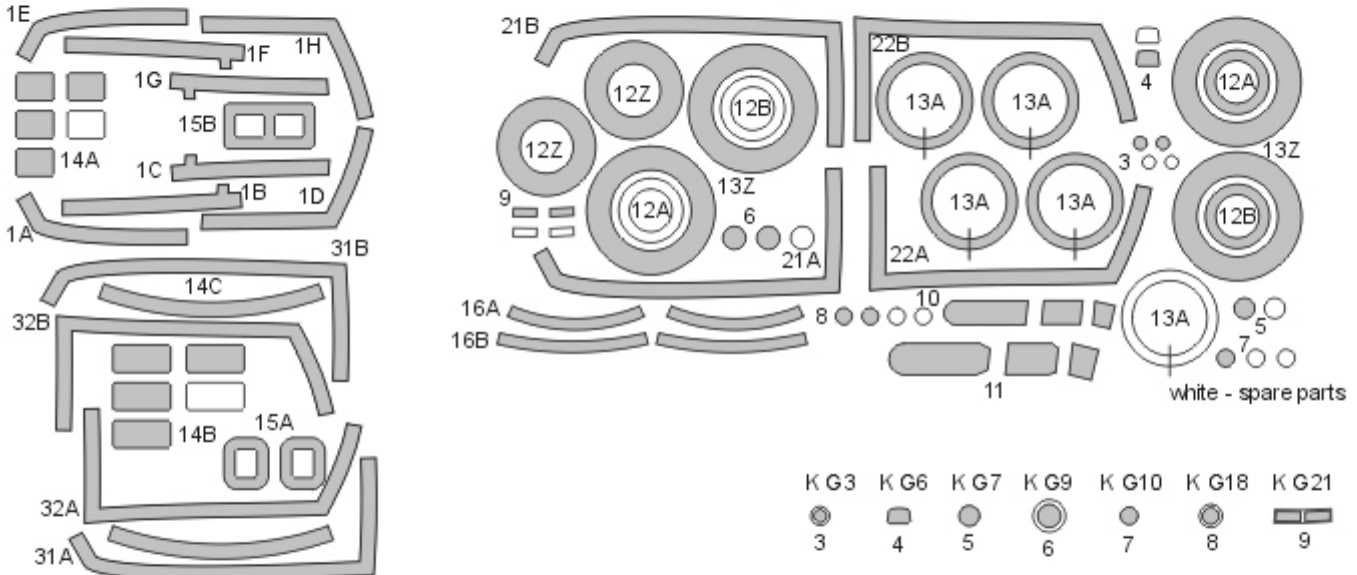

STEP 1 - exterior view  
mask interior, paint interior color

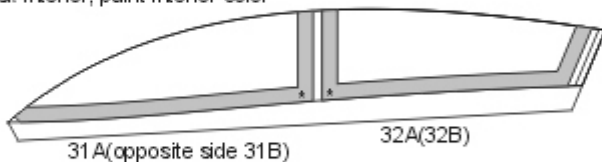

STEP 2  
mask exterior, paint black

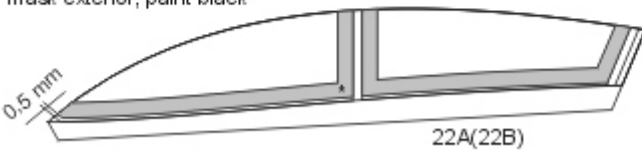

STEP 3  
mask exterior, paint camouflage color

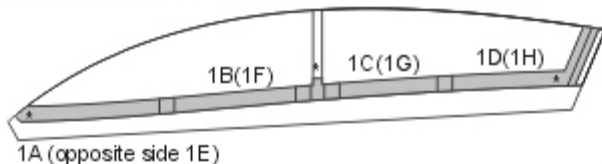

K D 4+D8    K F 26+F27, F19+F20

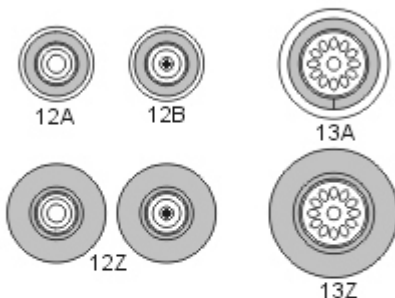

GBU-31  
paint olive  
mask  
paint gray

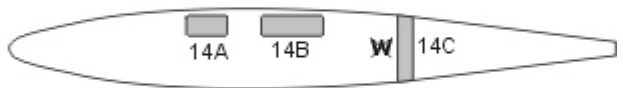

GBU-38



K G 19+G22  
STEP 1 - paint red

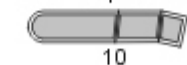

STEP 2 - paint camouflage color

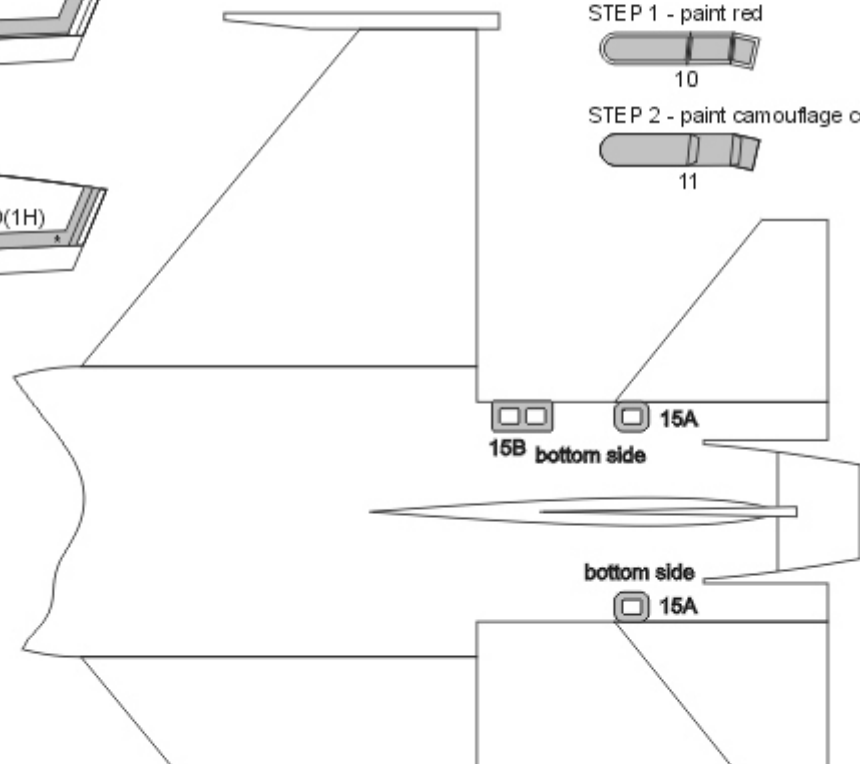
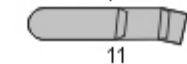





F-16 F110 engine EXHAUST NOZZLE kabuki masks

for Kinetic F-16 K48105 and derivative kits with J10+J12 exhaust nozzle parts

<http://mek.kosmo.cz/newware>

tom.nwkits@seznam.cz

**Important:**

Let the sprayed color dry before applying masks. Remove masks very carefully after painting.

Where the mask is divided into A and B parts, first apply part A, next part B.

The set does not include masks for all areas, so mask the rest with masking tape or liquid mask.

K kit part

^ start placing the mask from this point

Placing wet masks on wet surface is recommended, except those marked by **W**

