



NEW WARE NEWSLETTER

NEW MASKS MARCH 2023

NWAM1071 1/72 Su-22UM3K, Su-17UM3 BASIC kabuki masks
NWAM1072 1/72 Su-22UM3K, Su-17UM3 EXPERT kabuki masks
NWAM1073 1/48 B-26 Invader BASIC kabuki masks
NWAM1074 1/48 B-26 Invader EXPERT kabuki masks
NWAM1075 1/48 F-16B/D/F/I Fighting Falcon BASIC kabuki masks
NWAM1076 1/48 F-16B/D/F/I Fighting Falcon ADVANCED kabuki masks
NWAM1077 1/48 F-16B/D/F/I Fighting Falcon EXPERT kabuki masks
NWAM1078 1/48 F-16 Fighting Falcon F-100 engine EXHAUST NOZZLE kabuki masks
NWAM1079 1/48 F-16 Fighting Falcon F-110 engine EXHAUST NOZZLE kabuki masks
NWAM1080 1/48 Supermarine Spitfire Mk.XIV / Mk.XVIII BASIC kabuki masks
NWAM1081 1/48 Supermarine Spitfire Mk.XIV / Mk.XVIII EXPERT kabuki masks
NWAM1082 1/72 C-130J BASIC kabuki masks
NWAM1083 1/72 C-130J ADVANCED kabuki masks
NWAM1084 1/72 C-130J EXPERT kabuki masks
NWAM1085 1/48 F-16A MLU NATO Viper / F-16C Block 25/42 BASIC kabuki masks
NWAM1086 1/48 F-16A MLU NATO Viper / F-16C Block 25/42 ADVANCED kabuki masks
NWAM1087 1/48 F-16A MLU NATO Viper / F-16C Block 25/42 EXPERT kabuki masks
NWAM1088 1/48 F-16 F-100 EXHAUST NOZZLE kabuki masks



Su-22UM3K, Su-17UM3 BASIC kabuki masks

for MODELSIT no. 72051 and 72050 kits

<http://mek.kosmo.cz/newware>

tom.nwkits@seznam.cz

Important:

Let the sprayed color dry before applying masks. Remove masks very carefully after painting.

Where the mask is divided into A and B parts, first apply part A, next part B.

The set does not include masks for all areas, so mask the rest with masking tape or liquid mask.

K kit part

^ start placing the mask from this point

Placing wet masks on wet surface is recommended, except those marked by **W**

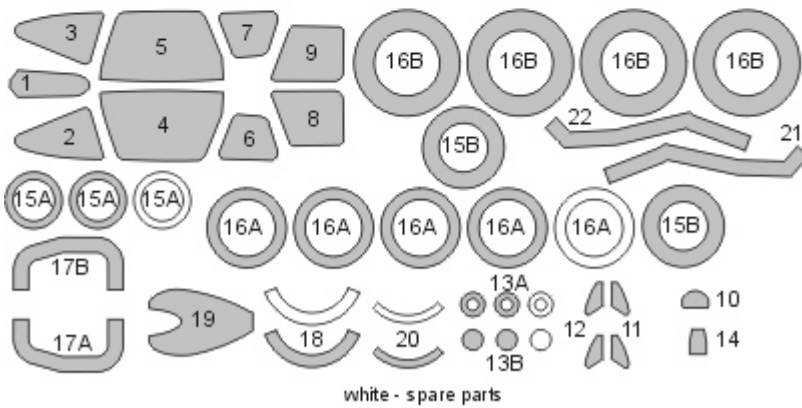

white - spare parts

K K3, K4 K K2 K K5

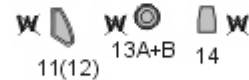

K E16+E13

K E15+E17

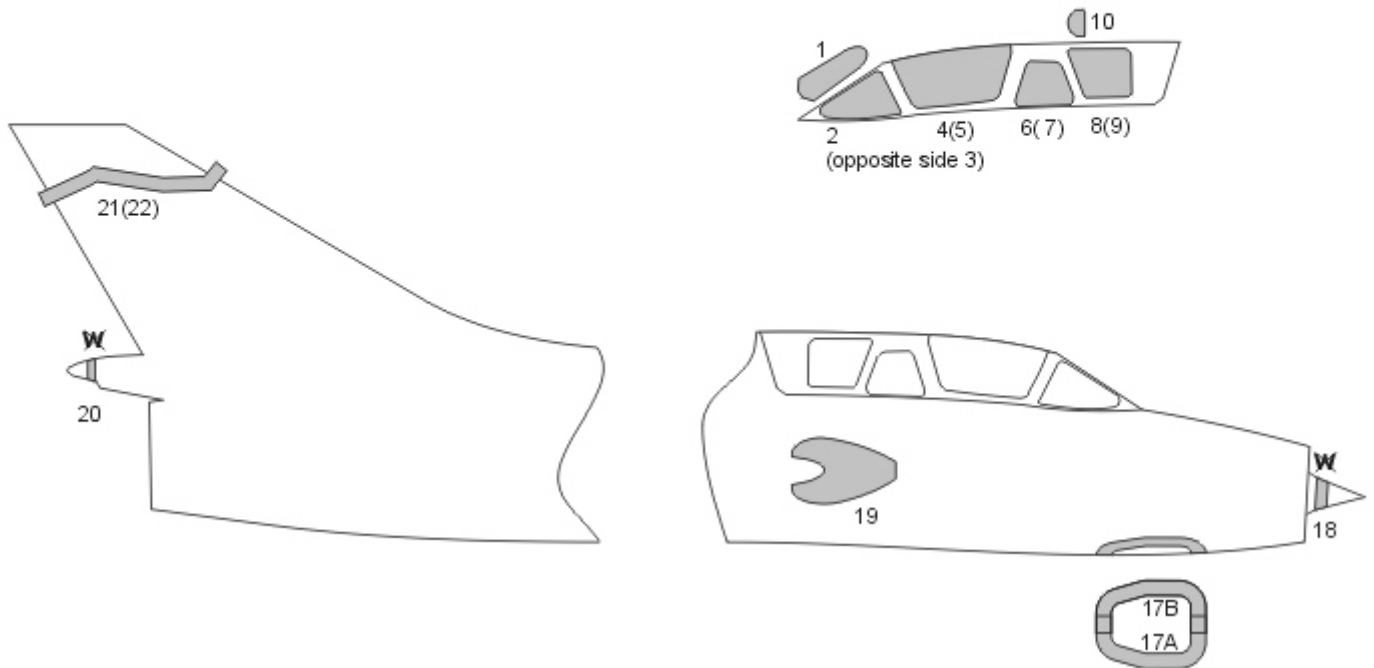
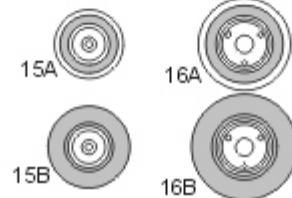



Su-22UM3K, Su-17UM3 EXPERT kabuki masks
for MODELSIT no. 72051 and 72050 kits
<http://mek.kosmo.cz/newware>

INCLUDES ALSO WINDOWS
INNER SIDE MASKS

tom.nwkits@seznam.cz

Important:

Let the sprayed color dry before applying masks. Remove masks very carefully after painting.
Where the mask is divided into A and B parts, first apply part A, next part B.
The set does not include masks for all areas, so mask the rest with masking tape or liquid mask.

K kit part

^ start placing the mask from this point

Placing wet masks on wet surface is recommended, except those marked by **W**

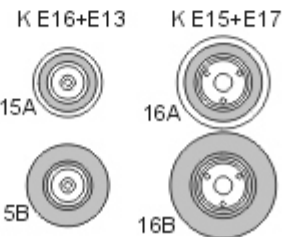
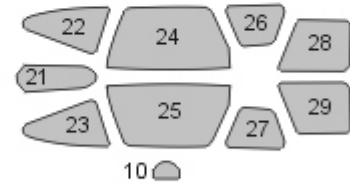
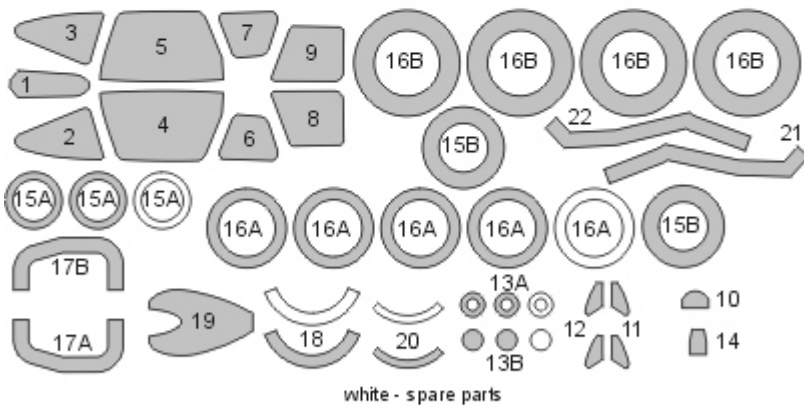

KK3, K4 KK2 KK5

W 11(12) **W** 13A+B **W** 14

STEP 1 - exterior view
mask interior, paint interior color

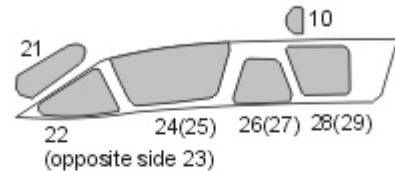

STEP 2
mask exterior, paint camouflage color

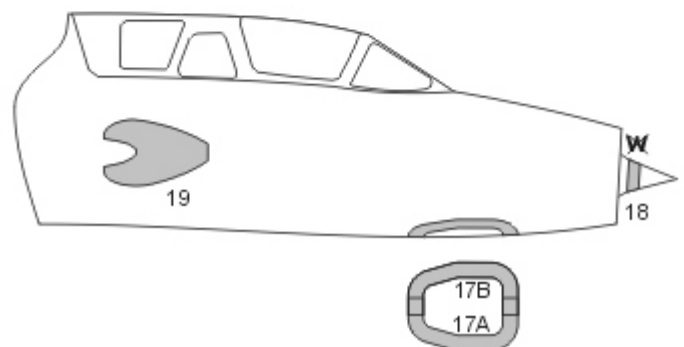
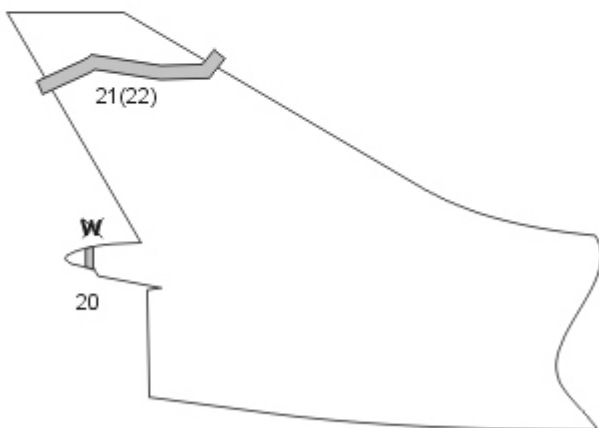
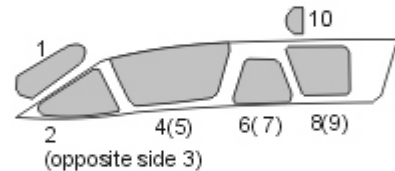



B-26 Invader BASIC kabuki masks

for Revell 03823 kit

<http://mek.kosmo.cz/newware>

tom.nwkits@seznam.cz

Important:

Let the sprayed color dry before applying masks. Remove masks very carefully after painting.
Where the mask is divided into A and B parts, first apply part A, next part B.
The set does not include masks for all areas, so mask the rest with masking tape or liquid mask.

K kit part

* start placing the mask from this point

Placing wet masks on wet surface is recommended, except those marked by **W**

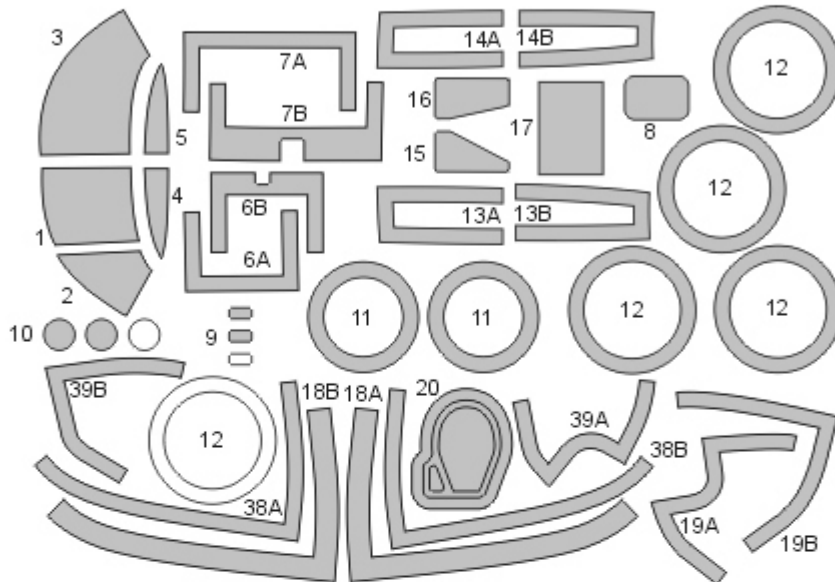

white - spare parts

STEP 1 - exterior view

mask interior, paint frame color

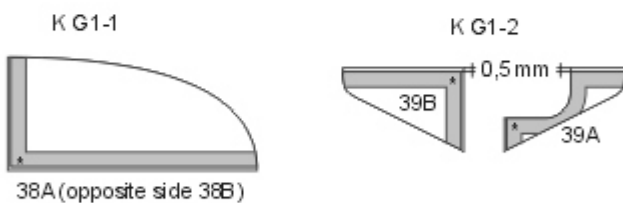

STEP 2

mask exterior, paint camouflage color

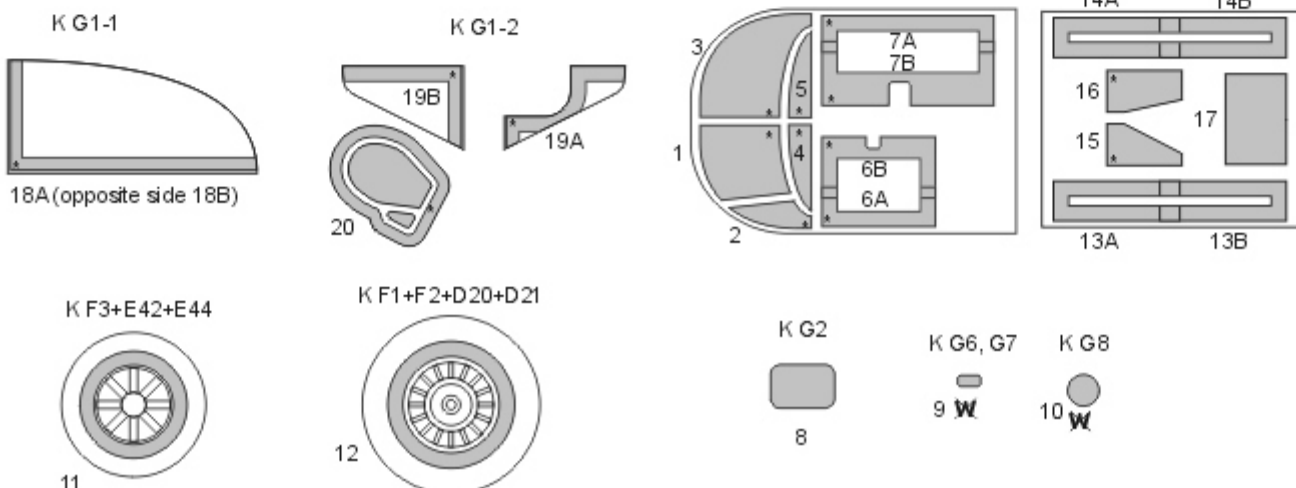

NWAM1074



B-26 Invader EXPERT kabuki masks

for Revell 03823 kit

<http://mek.kosmo.cz/newware>

INCLUDES AIRCRAFT CANOPY
INNER SIDE AND CAMOUFLAGE
MASKS

1/48 scale

tom.nwkits@seznam.cz

Important:

Let the sprayed color dry before applying masks. Remove masks very carefully after painting.

Where the mask is divided into A and B parts, first apply part A, next part B.

The set does not include masks for all areas, so mask the rest with masking tape or liquid mask.

K kit part

^ start placing the mask from this point

Placing wet masks on wet surface is recommended, except those marked by **W**

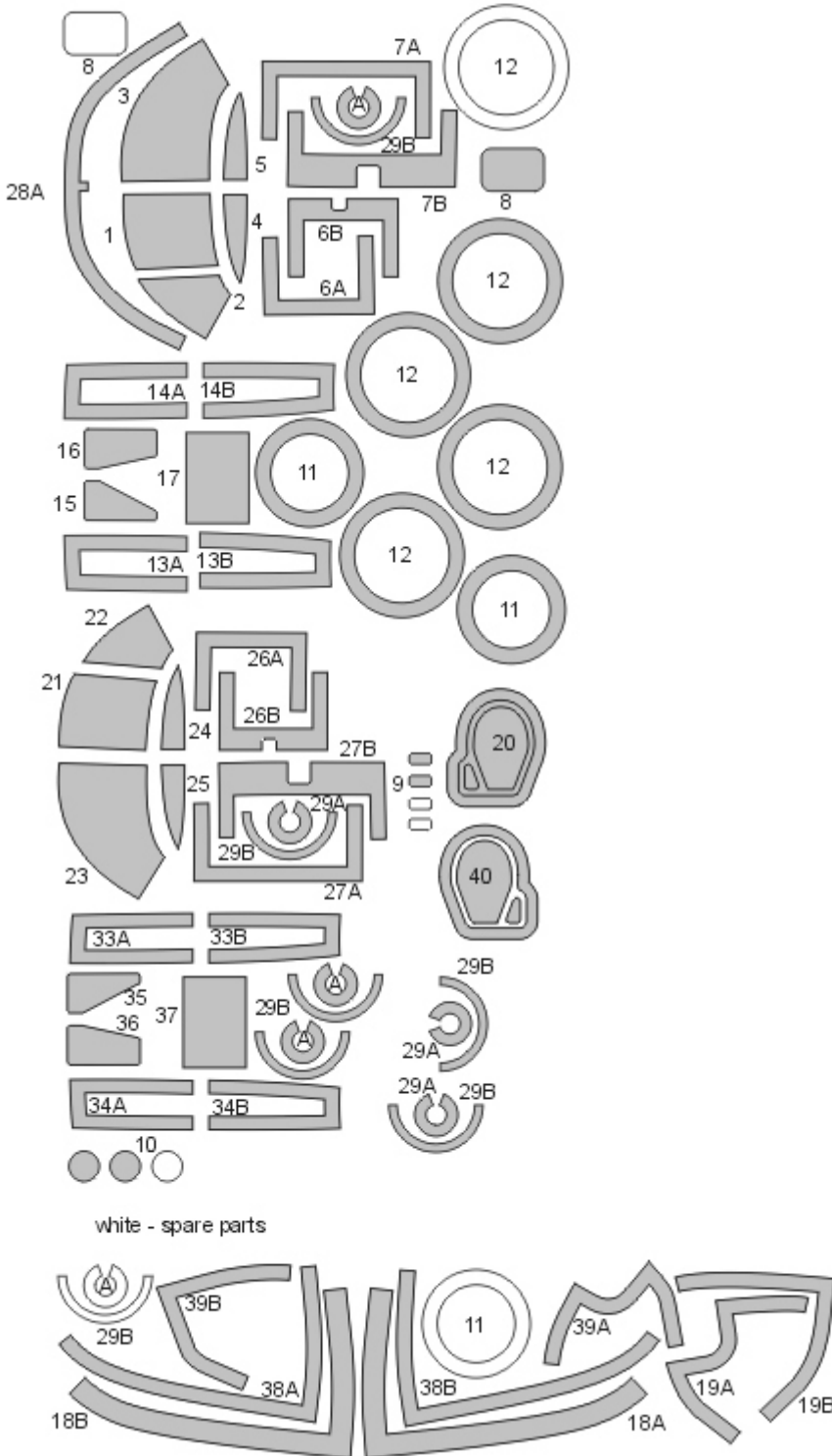

STEP 1 - exterior view
mask interior, paint interior color

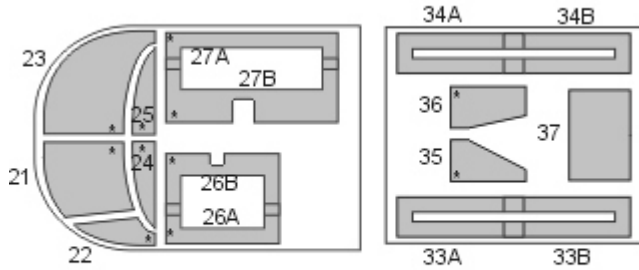

Paint frame color
K G1-1

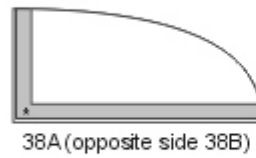

Paint frame color
K G1-2

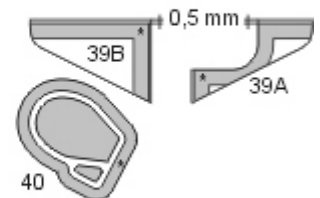

Paint interior color

STEP 2
mask exterior, paint camouflage color

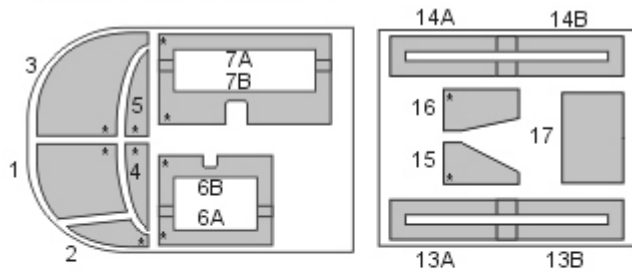

K G1-1

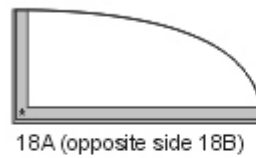

K G1-2

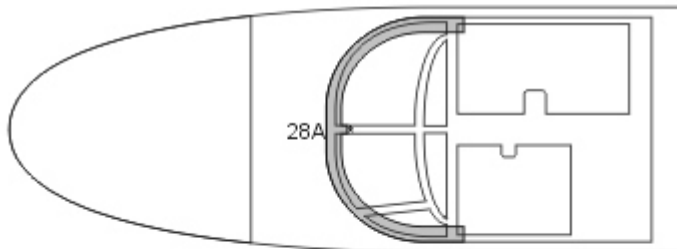
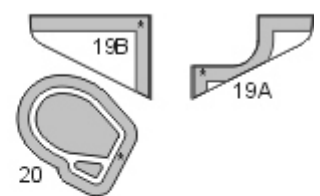

K F3+E 42+E44

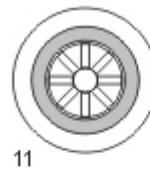

K F1+F2+D20+D21

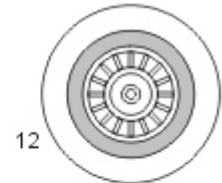

K G2



K G6, G7



K G8



K D 38+D42+D49, D9+D10+D49
(yellow stripes)

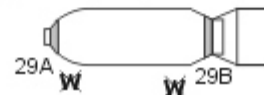

NWAM1075

1/48 scale



F-16B/D/F/I Fighting Falcon BASIC kabuki masks

for ALL Hasegawa 2-seat F-16(B/D/F/I) kits

<http://mek.kosmo.cz/newware>

tom.nwkits@seznam.cz

Use also NWAM1078 F-100 engine or NWAM1079 F-110 engine exhaust nozzles kabuki masks

Important:

Let the sprayed color dry before applying masks. Remove masks very carefully after painting.

Where the mask is divided into A and B parts, first apply part A, next part B.

The set does not include masks for all areas, so mask the rest with masking tape or liquid mask.

K kit part

^ start placing the mask from this point

Placing wet masks on wet surface is recommended, except those marked by **W**

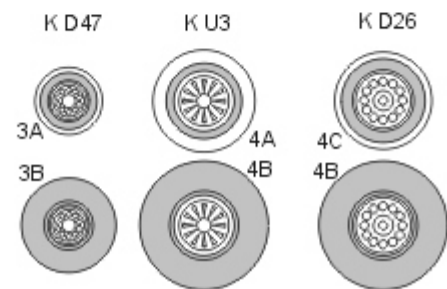
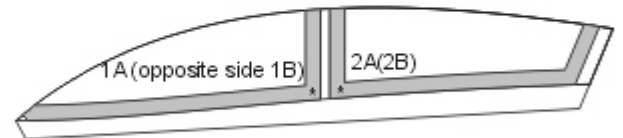
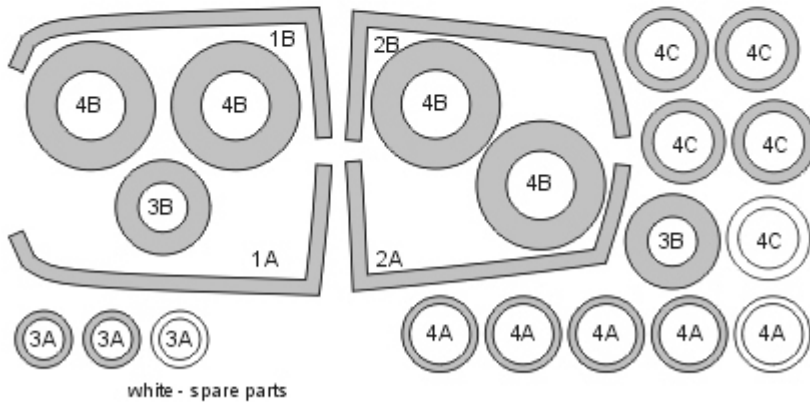

NWAM1076

1/48 scale



F-16B/D/F/I Fighting Falcon ADVANCED kabuki masks

for ALL Hasegawa 2-seat F-16(B/D/F/I) kits

<http://mek.kosmo.cz/newware>

INCLUDES ALSO WINDOWS
SEAL AND CAMOUFLAGE
DETAILS MASKS

tom.nwkits@seznam.cz

Use also NWAM1078 F-100 engine or NWAM1079 F-110 engine exhaust nozzles kabuki masks

Important:

Let the sprayed color dry before applying masks. Remove masks very carefully after painting.

Where the mask is divided into A and B parts, first apply part A, next part B.

The set does not include masks for all areas, so mask the rest with masking tape or liquid mask.

K kit part

* start placing the mask from this point

Placing wet masks on wet surface is recommended, except those marked by **W**

0,5 mm

0,7 mm

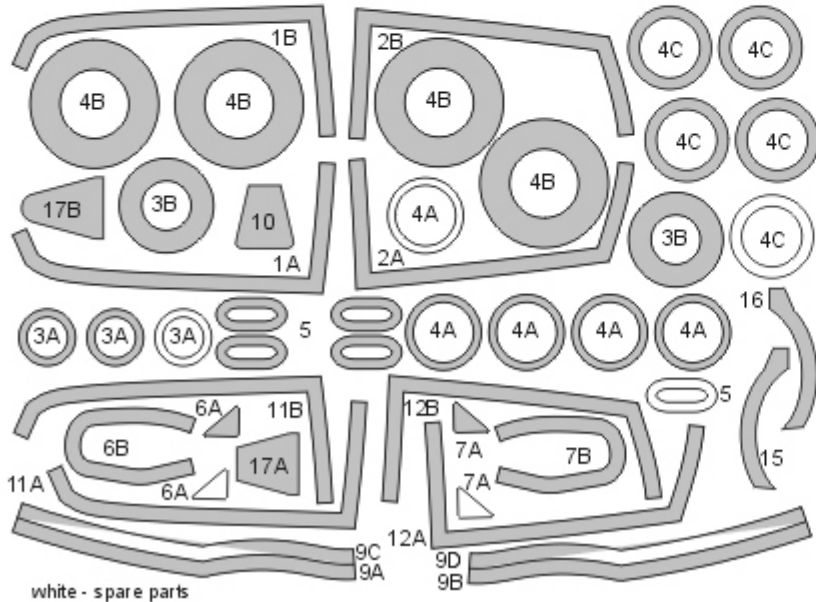

STEP 1
paint interior color

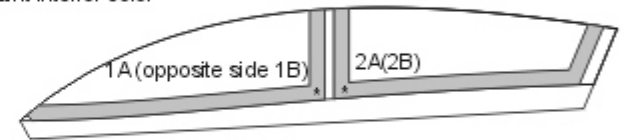

STEP 2
paint black

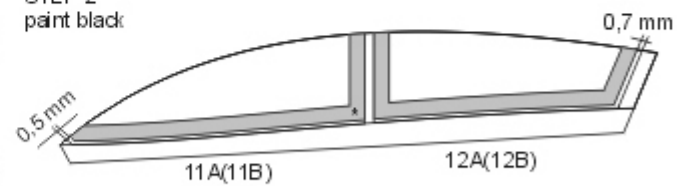

STEP 3
paint camouflage color

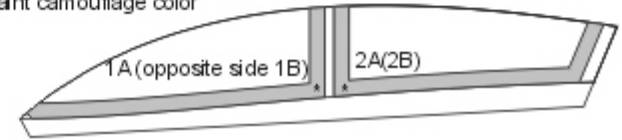

white - spare parts

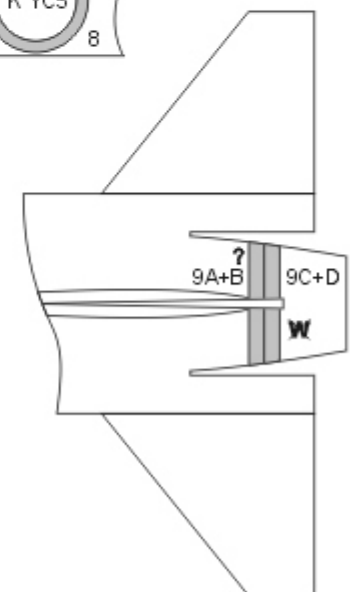
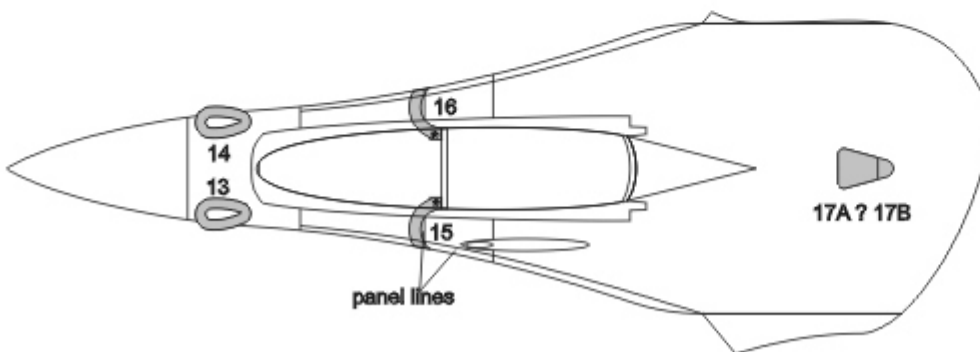
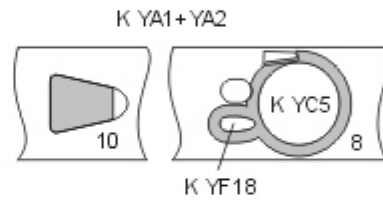
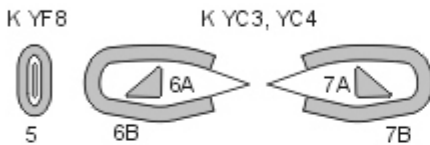
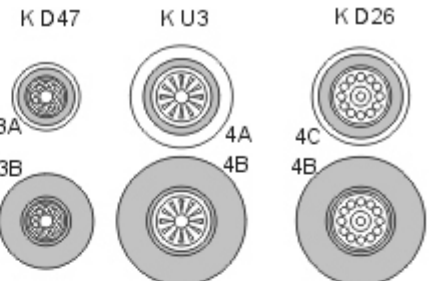
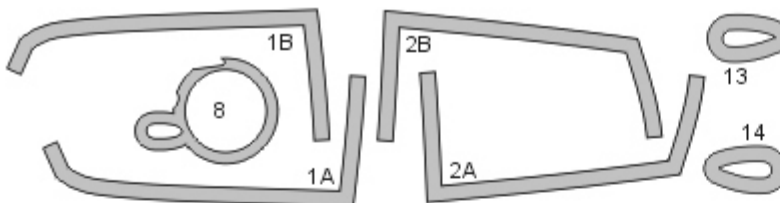

NWAM1077



F-16B/D/F/I Fighting Falcon EXPERT kabuki masks
for ALL Hasegawa 2-seat F-16(B/D/F/I) kits
<http://mek.kosmo.cz/newware>

INCLUDES ALSO WINDOWS
SEAL AND INNER SIDE
AND CAMOUFLAGE DETAILS MASKS

1/48 scale

tom.nwkits@seznam.cz

Use also NWAM1078 F-100 engine or NWAM1079 F-110 engine exhaust nozzles kabuki masks

Important:

Let the sprayed color dry before applying masks. Remove masks very carefully after painting.

Where the mask is divided into A and B parts, first apply part A, next part B.

The set does not include masks for all areas, so mask the rest with masking tape or liquid mask.

K kit part

* start placing the mask from this point

Placing wet masks on wet surface is recommended, except those marked by **W**

0,5 mm

0,7 mm

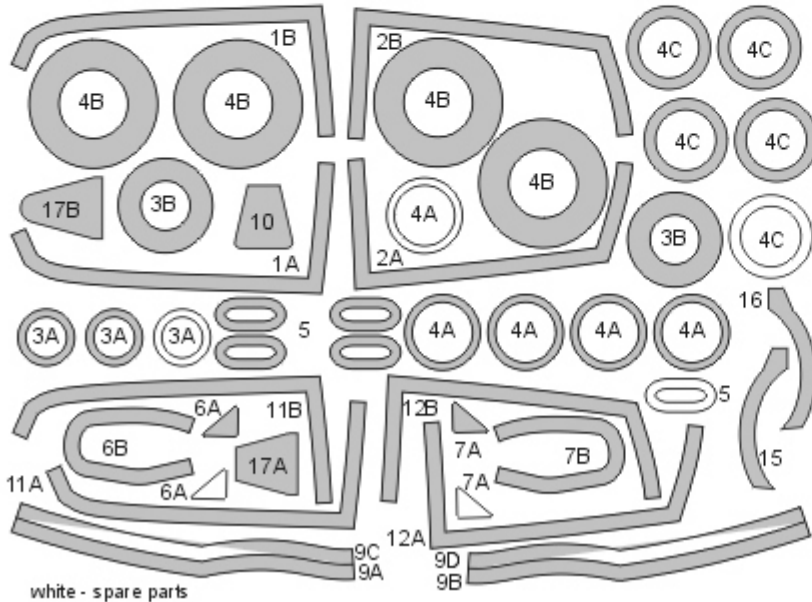

white - spare parts

STEP 1 - exterior view
mask interior, paint interior color

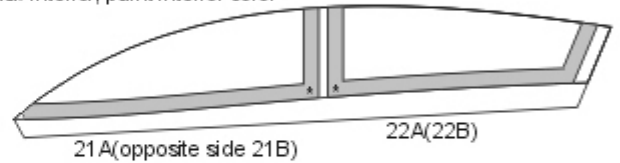

STEP 2
mask exterior, paint black

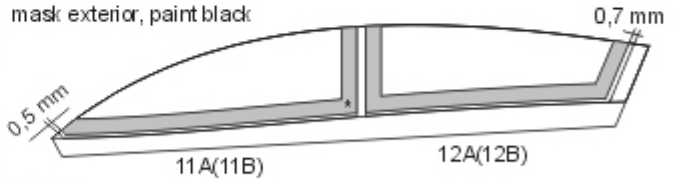

STEP 3
mask exterior, paint camouflage color

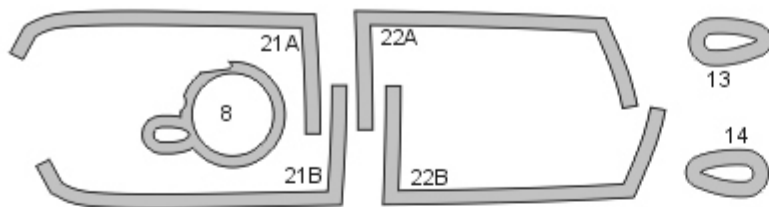

K D47

K U3

K D26

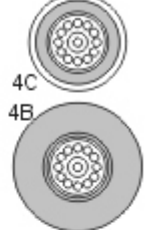

K YF8

K YC3, YC4



K YA1+YA2

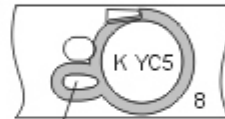
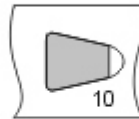

K YF18

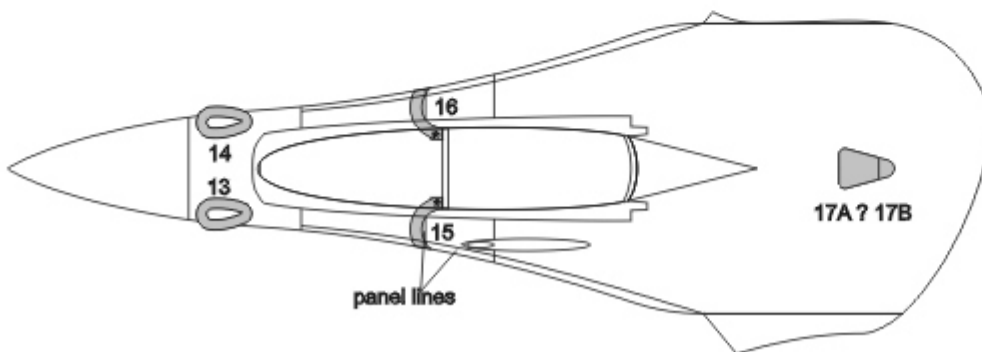

panel lines

17A? 17B

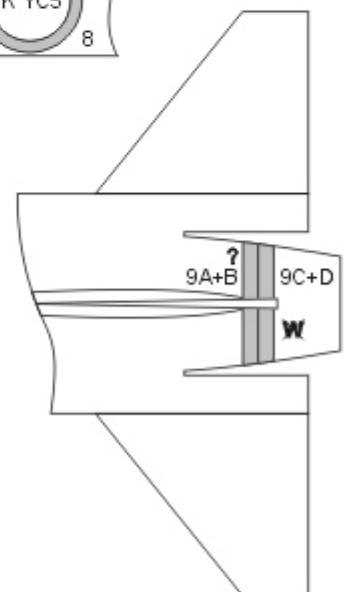

NWAM1078

1/48 scale



F-16 Fighting Falcon F-100 engine EXHAUST NOZZLE kabuki masks

for ALL Hasegawa F-16 kits with A-1 part exhaust nozzle

<http://mek.kosmo.cz/newware>

tom.nwkits@seznam.cz

Use also NWAM1075 - 78 or NWAM0989-91 F-16 masks

Important:

Let the sprayed color dry before applying masks. Remove masks very carefully after painting.

Where the mask is divided into A and B parts, first apply part A, next part B.

The set does not include masks for all areas, so mask the rest with masking tape or liquid mask.

K kit part

^ start placing the mask from this point

Placing wet masks on wet surface is recommended, except those marked by **W**

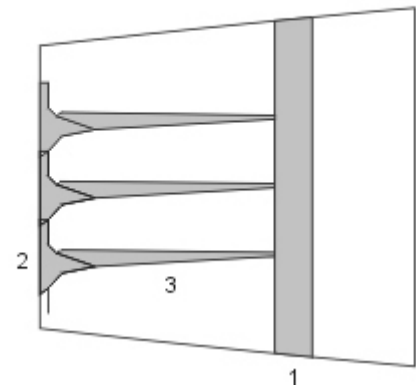
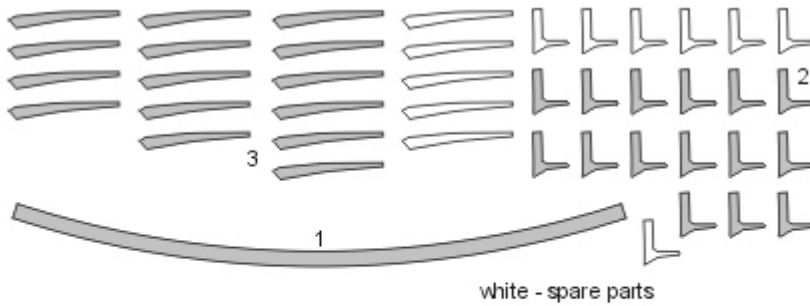

NWAM1079

1/48 scale



F-16 Fighting Falcon F-110 engine EXHAUST NOZZLE kabuki masks
for ALL Hasegawa F-16 kits with H5+L1+L2+L3 parts exhaust nozzle
<http://mek.kosmo.cz/newware>

tom.nwkits@seznam.cz

Use also NWAM1075 - 78 or NWAM0989-91 F-16 masks

Important:

Let the sprayed color dry before applying masks. Remove masks very carefully after painting.
Where the mask is divided into A and B parts, first apply part A, next part B.
The set does not include masks for all areas, so mask the rest with masking tape or liquid mask.

K kit part

^ start placing the mask from this point

Placing wet masks on wet surface is recommended, except those marked by **W**

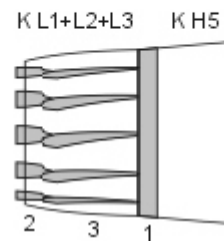
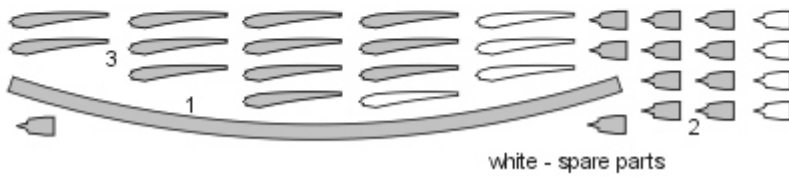

NWAM1080

1/48 scale



Supermarine Spitfire Mk.XIV / Mk.XVIII BASIC kabuki masks

for A05135, A05139 and A05140 Airfix kits

<http://mek.kosmo.cz/newware>

tom.nwkits@seznam.cz

Important:

Let the sprayed color dry before applying masks. Remove masks very carefully after painting.

Where the mask is divided into A and B parts, first apply part A, next part B.

The set does not include masks for all areas, so mask the rest with masking tape or liquid mask.

K kit part

^ start placing the mask from this point

Placing wet masks on wet surface is recommended, except those marked by **W**

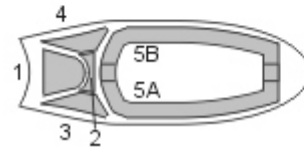
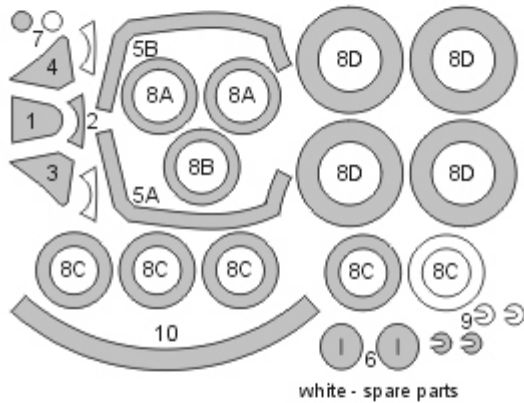

K D03(D04)+D16, D01, D02 K D05(D06)+D15 K D37

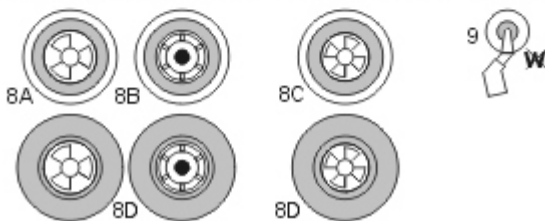

NWAM1081



Supermarine Spitfire Mk.XIV / Mk.XVIII EXPERT kabuki masks

for A05135, A05139 and A05140 Airfix kits

<http://mek.kosmo.cz/newware>

INCLUDES ALSO WINDOWS
INNER SIDE MASKS

1/48 scale

tom.nwkits@seznam.cz

Important:

Let the sprayed color dry before applying masks. Remove masks very carefully after painting.

Where the mask is divided into A and B parts, first apply part A, next part B.

The set does not include masks for all areas, so mask the rest with masking tape or liquid mask.

K kit part

^ start placing the mask from this point

Placing wet masks on wet surface is recommended, except those marked by **W**

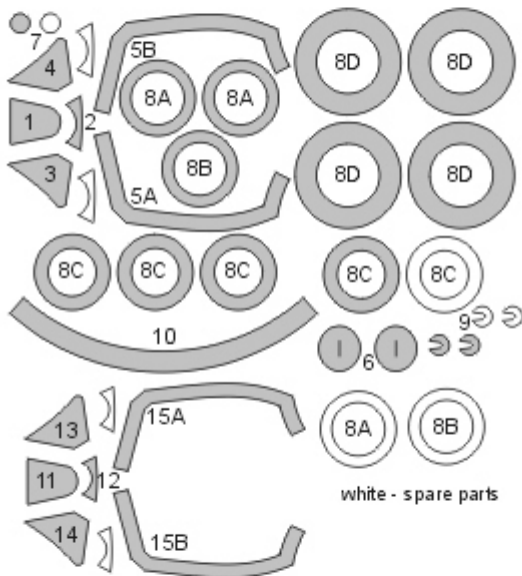

white - spare parts

STEP 1 - exterior view
mask interior, paint interior color

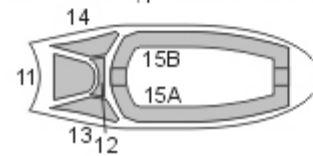

K E08, E09

K E04



6

STEP 2
mask exterior, paint camouflage color

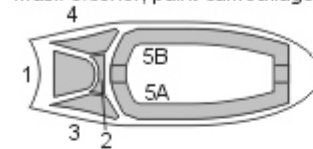

K A25

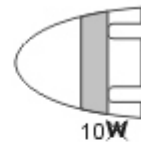

10W

K D03(D04)+D16, D01, D02

K D05(D06)+D15

K D37

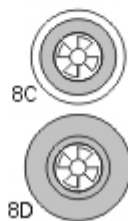
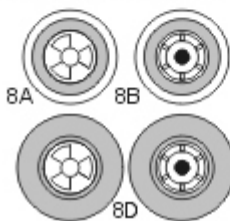



C-130J BASIC kabuki masks

for Zvezda 7325 kit

<http://mek.kosmo.cz/newware>

tom.nwkits@seznam.cz

Important:

Let the sprayed color dry before applying masks. Remove masks very carefully after painting.
Where the mask is divided into A and B parts, first apply part A, next part B.
The set does not include masks for all areas, so mask the rest with masking tape or liquid mask.

K kit part

* start placing the mask from this point

Placing wet masks on wet surface is recommended, except those marked by **W**

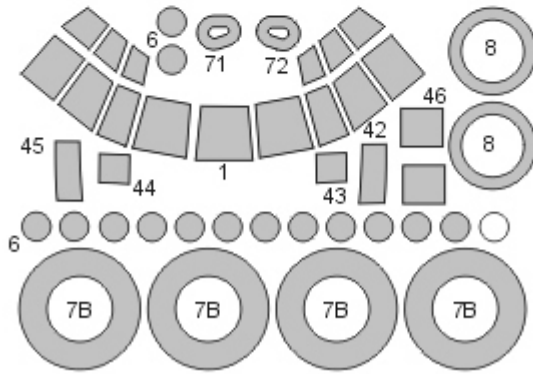

WHITE - SPARE MASKS

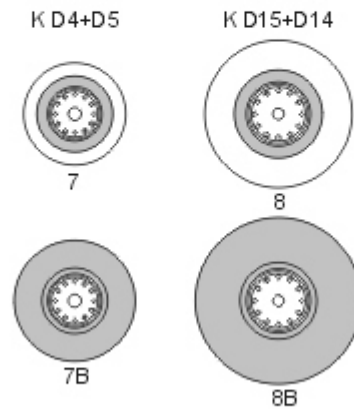
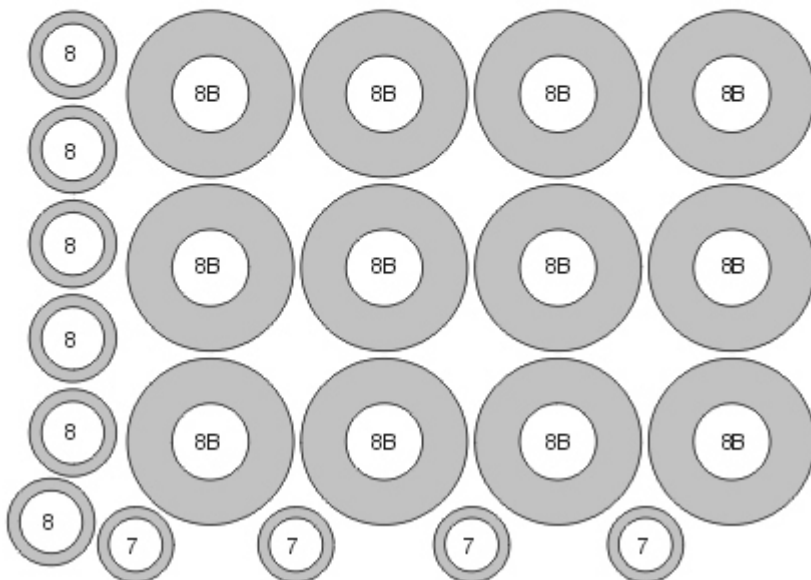
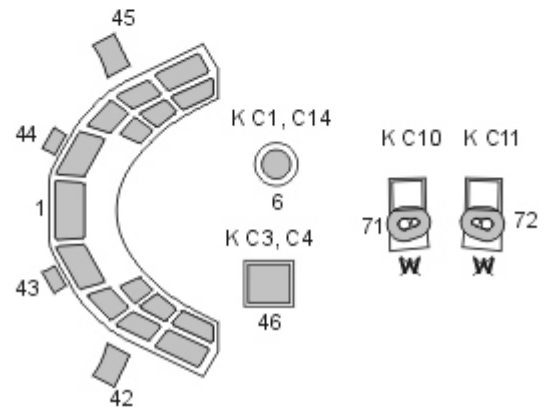



NWAM1083

C-130J ADVANCED kabuki masks

for Zvezda 7325 kit

<http://mek.kosmo.cz/newware>

INCLUDES ALSO WINDOWS
SEAL AND CAMOUFLAGE MASKS

1/72 scale

tom.nwkits@seznam.cz

Important:

Let the sprayed color dry before applying masks. Remove masks very carefully after painting.
Where the mask is divided into A and B parts, first apply part A, next part B.
The set does not include masks for all areas, so mask the rest with masking tape or liquid mask.

K kit part

^ start placing the mask from this point

Placing wet masks on wet surface is recommended, except those marked by **W**

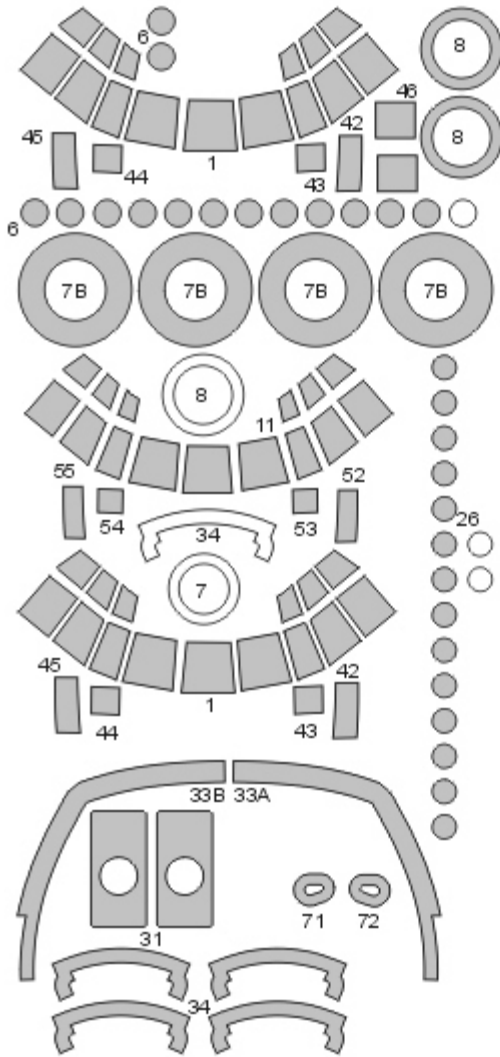

K C1, C14 - interior side

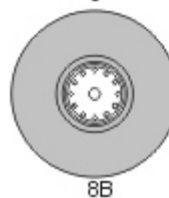
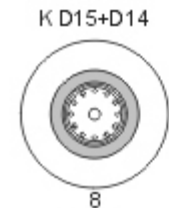

K D8, D13

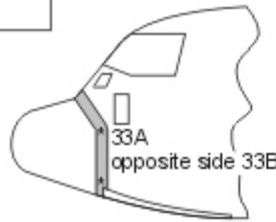
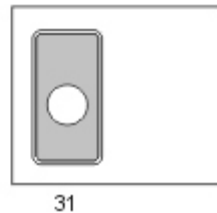

STEP 1
paint interior color

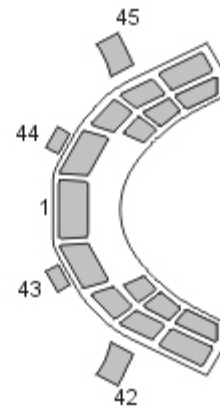

STEP 2
paint seal color

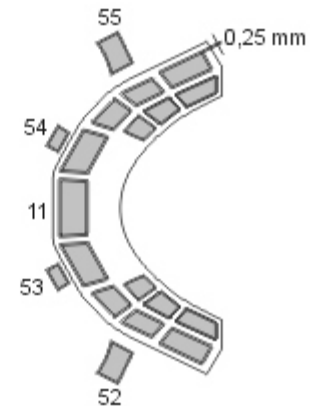

WHITE - SPARE MASKS

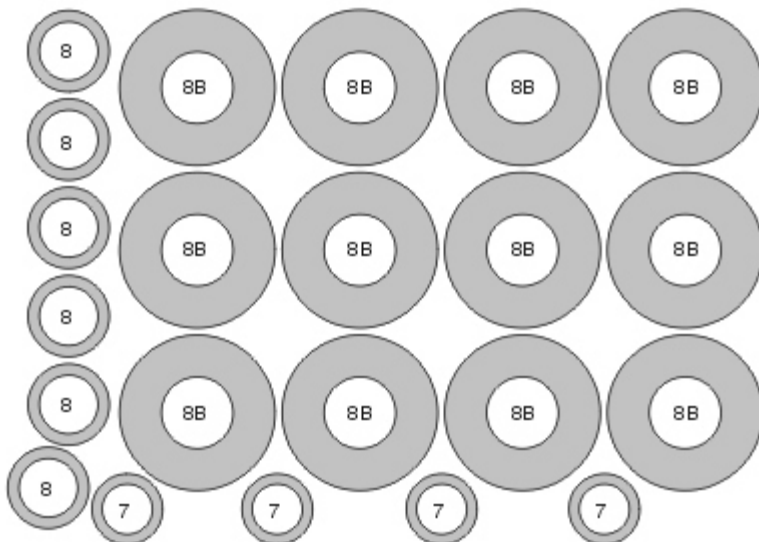

K C10 K C11

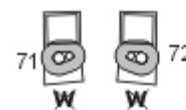

KE2



STEP 3
paint camouflage color

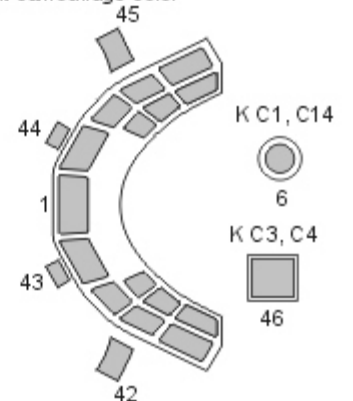



NWAM1084

C-130J EXPERT kabuki masks

for Zvezda 7325 kit

<http://mek.kosmo.cz/newware>

INCLUDES ALSO WINDOWS
INNER SIDE AND SEAL MASKS
AND CAMOUFLAGE MASKS

1/72 scale

tom.nwkits@seznam.cz

Important:

Let the sprayed color dry before applying masks. Remove masks very carefully after painting.
Where the mask is divided into A and B parts, first apply part A, next part B.
The set does not include masks for all areas, so mask the rest with masking tape or liquid mask.

K kit part

^ start placing the mask from this point

Placing wet masks on wet surface is recommended, except those marked by **W**

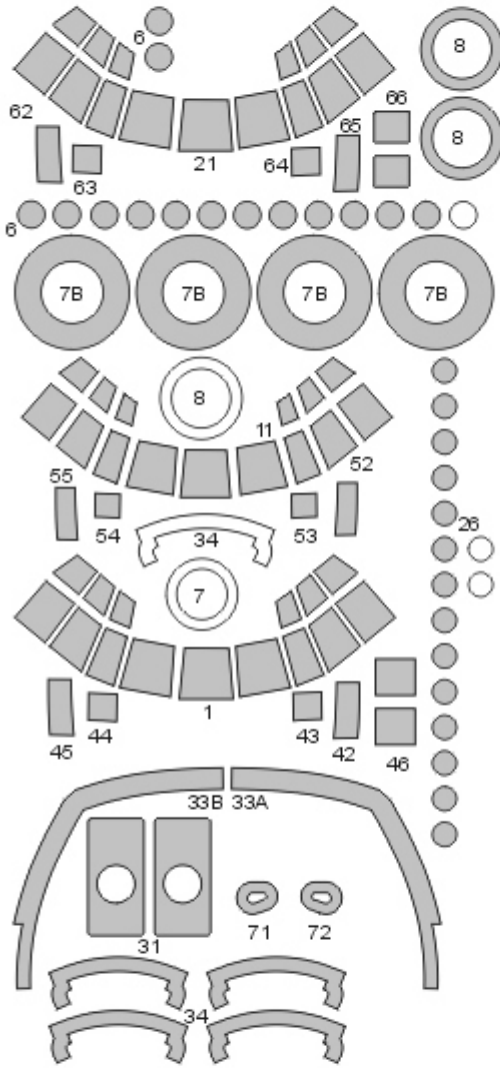

K C1, C14 - interior side



K D4+D5



K D15+D14

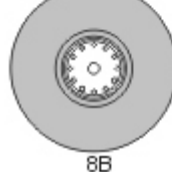
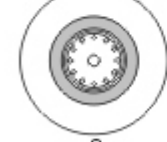

K D8, D13

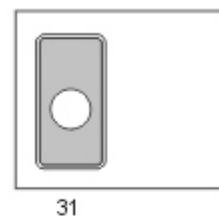

STEP 1 - exterior view
mask interior, paint interior color

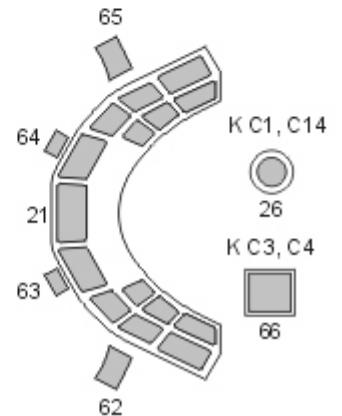

STEP 2
mask exterior, paint seal color

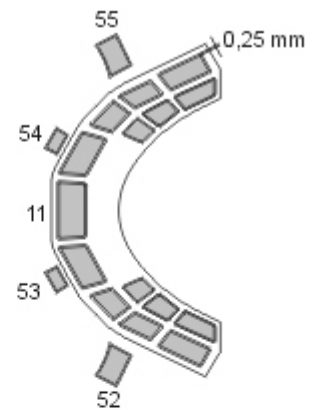

WHITE - SPARE MASKS

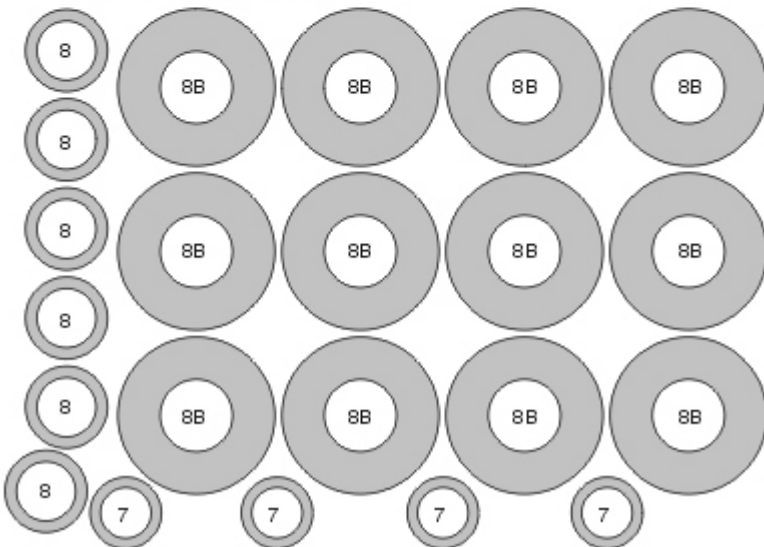

KE 2



STEP 3
mask exterior, paint camouflage color

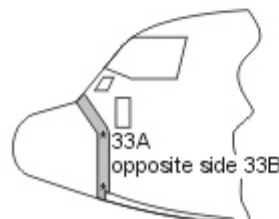
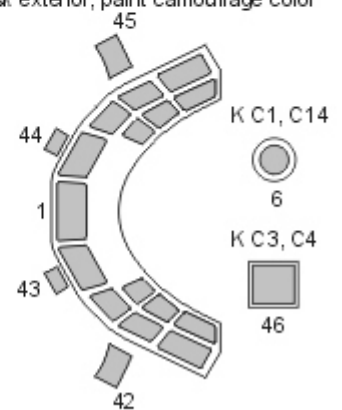

NWAM1085

1/48 scale



F-16A MLU NATO Viper / F-16C Block 25/42 BASIC kabuki masks

for Kinetic K48100 and K48102 kits

<http://mek.kosmo.cz/newware>

tom.nwkits@seznam.cz

Use also NWAM1088 F-100 engine exhaust nozzle kabuki masks

Important:

Let the sprayed color dry before applying masks. Remove masks very carefully after painting.

Where the mask is divided into A and B parts, first apply part A, next part B.

The set does not include masks for all areas, so mask the rest with masking tape or liquid mask.

K kit part

* start placing the mask from this point

Placing wet masks on wet surface is recommended, except those marked by **W**

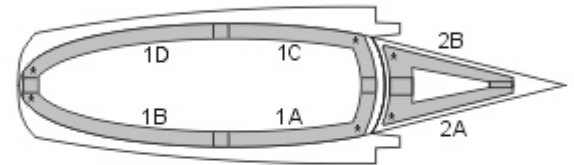
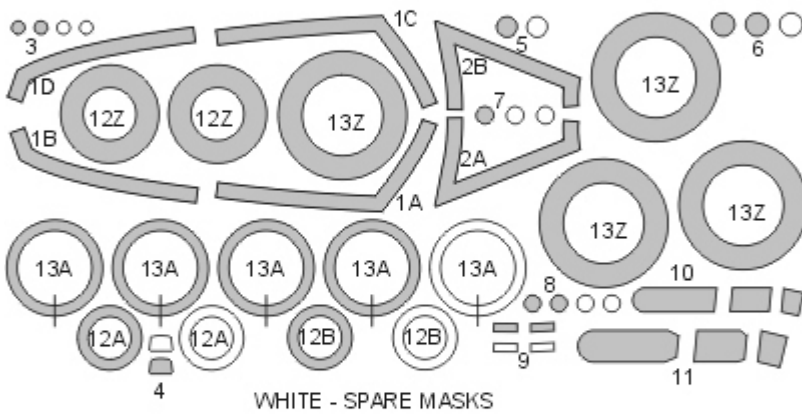

K D4+D8

K F26+F27, F19+F20

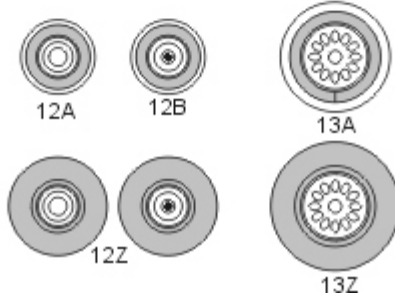

K G19+G22

STEP 1 - paint red



10

STEP 2 - paint camouflage color



11

NWAM1086



F-16A MLU NATO Viper / F-16C Block 25/42 ADVANCED kabuki masks

for Kinetic K48100 and K48102 kits

<http://mek.kosmo.cz/newware>

INCLUDES ALSO WINDOWS
SEAL AND CAMOUFLAGE
MASKS

1/48 scale

tom.nwkits@seznam.cz

Use also NWAM1088 F-100 engine exhaust nozzle kabuki masks

Important:

Let the sprayed color dry before applying masks. Remove masks very carefully after painting.
Where the mask is divided into A and B parts, first apply part A, next part B.
The set does not include masks for all areas, so mask the rest with masking tape or liquid mask.

K kit part

^ start placing the mask from this point

Placing wet masks on wet surface is recommended, except those marked by **W**

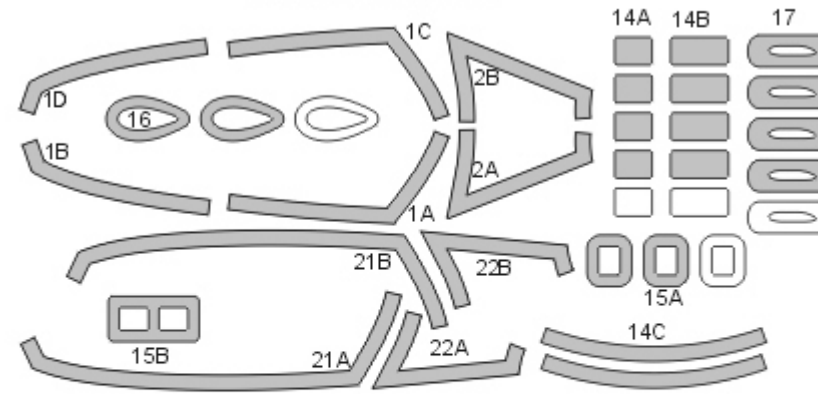
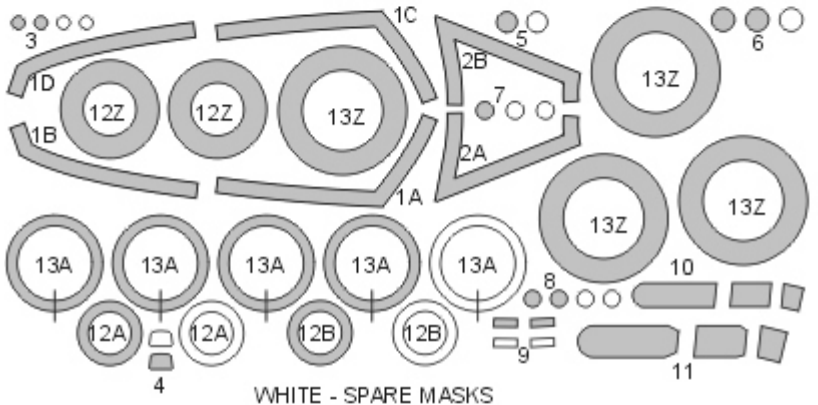

STEP 1
paint interior color

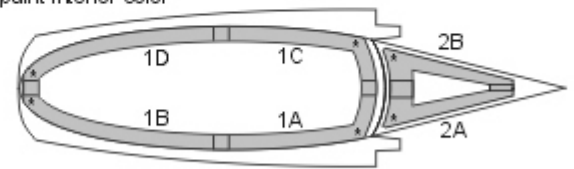

STEP 2
paint seal color

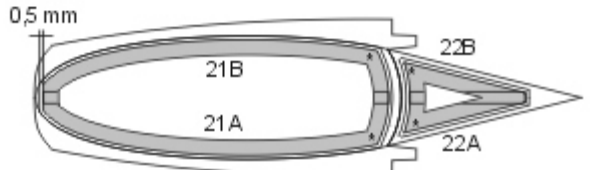

STEP 3
paint camouflage color

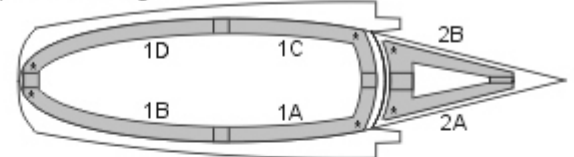

K D4+D8 K F26+F27, F19+F20

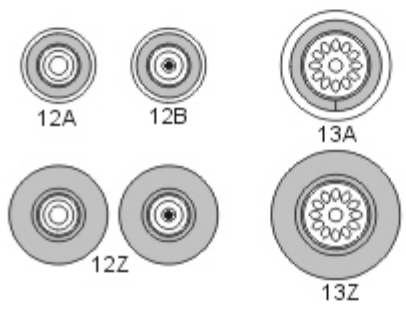

K G19+G22
STEP 1 - paint red
10
STEP 2 - paint camouflage color
11

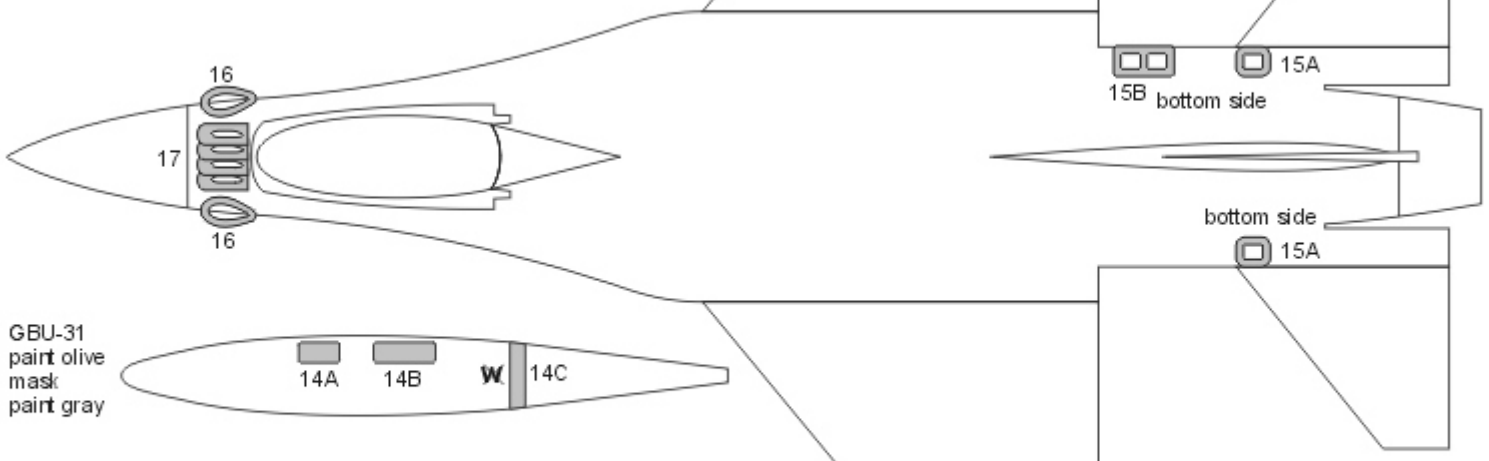

GBU-31
paint olive
mask
paint gray

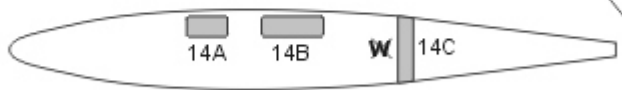

NWAM1087



F-16A MLU NATO Viper / F-16C Block 25/42 EXPERT kabuki masks

for Kinetic K48100 and K48102 kits

<http://mek.kosmo.cz/newware>

INCLUDES ALSO WINDOWS
SEAL, INNER SIDE
AND CAMOUFLAGE MASKS

1/48 scale

tom.nwkits@seznam.cz

Use also NWAM1088 F-100 engine exhaust nozzle kabuki masks

Important:

Let the sprayed color dry before applying masks. Remove masks very carefully after painting.

Where the mask is divided into A and B parts, first apply part A, next part B.

The set does not include masks for all areas, so mask the rest with masking tape or liquid mask.

K kit part

^ start placing the mask from this point

Placing wet masks on wet surface is recommended, except those marked by **W**

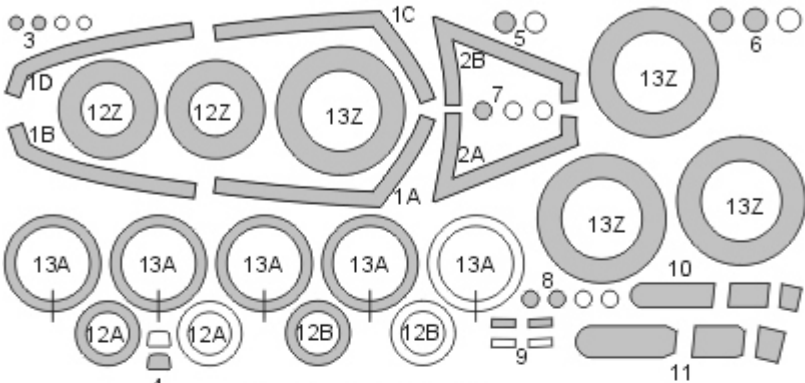

WHITE - SPARE MASKS

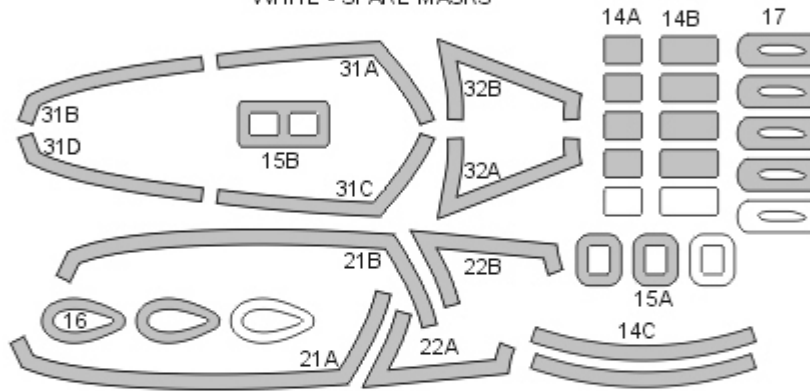

STEP 1 - exterior view
mask interior, paint interior color

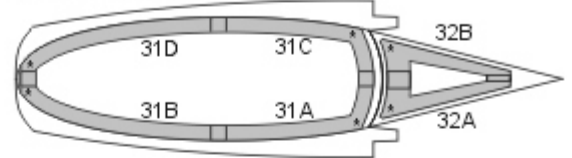

STEP 2
mask exterior, paint seal color

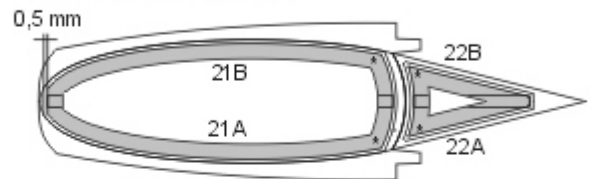

STEP 3
mask exterior, paint camouflage color

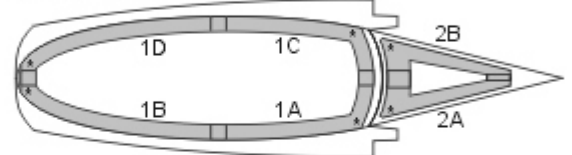

K D4+D8

K F26+F27, F19+F20

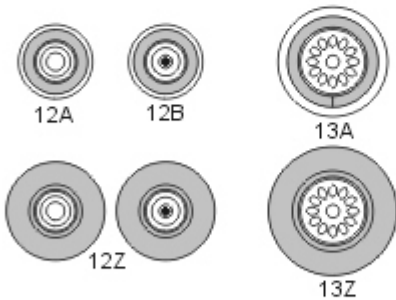

K G19+G22

STEP 1 - paint red

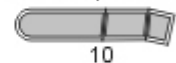

STEP 2 - paint camouflage color

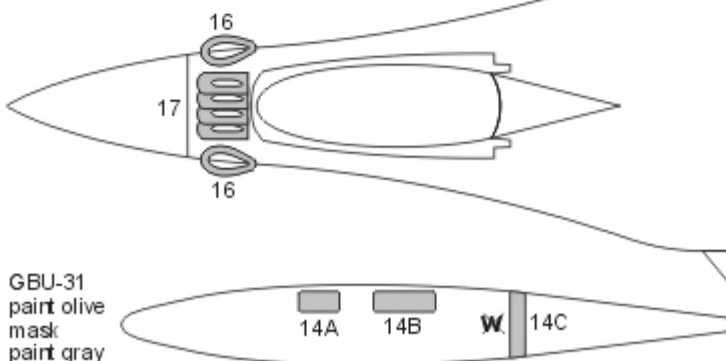
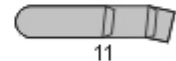

GBU-31
paint olive
mask
paint gray

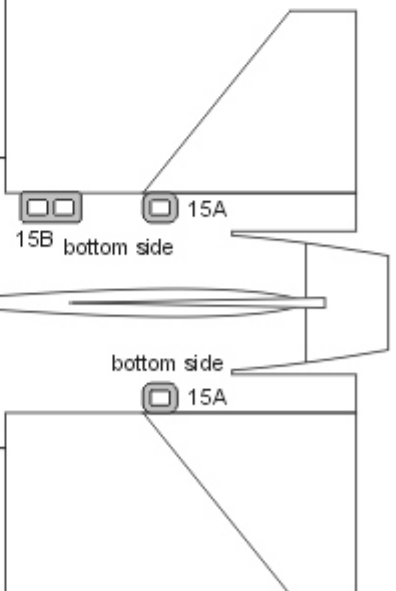



F-16 F-100 engine EXHAUST NOZZLE kabuki masks

for Kinetic F-16 K48100 and derivative kits with E4+E33 exhaust nozzle parts

<http://mek.kosmo.cz/newware>

tom.nwkits@seznam.cz

Important:

Let the sprayed color dry before applying masks. Remove masks very carefully after painting.

Where the mask is divided into A and B parts, first apply part A, next part B.

The set does not include masks for all areas, so mask the rest with masking tape or liquid mask.

K kit part

^ start placing the mask from this point

Placing wet masks on wet surface is recommended, except those marked by **W**

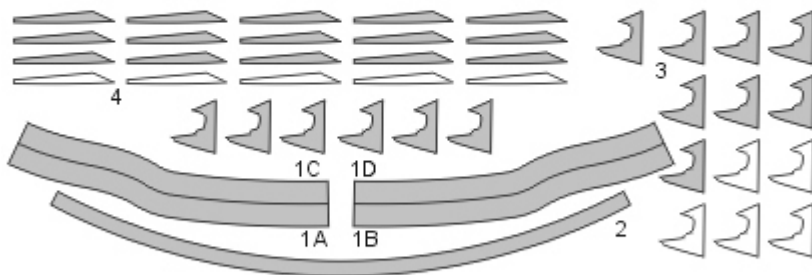

WHITE - SPARE MASKS

