



NEW WARE NEWSLETTER

NEW MASKS FEBRUARY 2023

NWAM 1057 1/48 MIG-15 BASIC kabuki masks
NWAM 1058 1/48 MIG-15 EXPERT kabuki masks
NWAM 1059 1/72 AH-64D(Block II) Apache BASIC kabuki masks
NWAM 1060 1/72 AH-64D(Block II) Apache BASIC kabuki masks
NWAM 1061 1/72 AH-64D(Block II) Apache EXPERT kabuki masks
NWAM 1062 1/48 MIL MI-8MT BASIC kabuki masks
NWAM 1063 1/48 MIL MI-8MT EXPERT kabuki masks
NWAM 1064 1/72 CH-53D BASIC kabuki masks
NWAM 1065 1/72 CH-53D EXPERT kabuki masks
NWAM 1066 1/72 F-86F Sabre BASIC kabuki masks
NWAM 1067 1/72 F-86F Sabre ADVANCED kabuki masks
NWAM 1068 1/72 F-86F Sabre EXPERT kabuki masks
NWAM 1069 1/48 IL-2 Shturm ovik mod. 1943 BASIC kabuki masks
NWAM 1070 1/48 IL-2 Shturm ovik mod. 1943 EXPERT kabuki masks



MIG-15 BASIC kabuki masks

for ALL Bronco and Hobby 2000 MIG-15 kits

<http://mek.kosmo.cz/newware>

tom.nwkits@seznam.cz

Important:

Let the sprayed color dry before applying masks. Remove masks very carefully after painting.

Where the mask is divided into A and B parts, first apply part A, next part B.

The set does not include masks for all areas, so mask the rest with masking tape or liquid mask.

K kit part

^ start placing the mask from this point

Placing wet masks on wet surface is recommended, except those marked by **W**

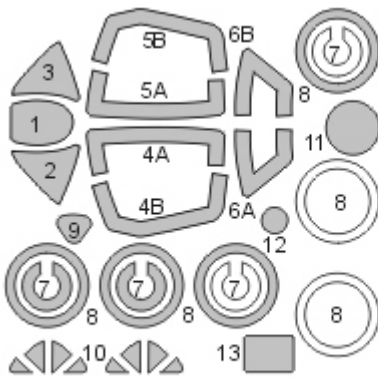

white - spare parts

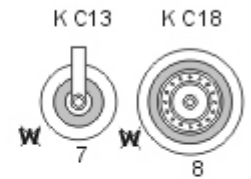
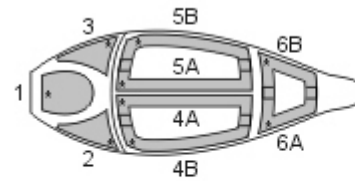

NWAM1058

1/48 scale



MIG-15 EXPERT kabuki masks
for ALL Bronco and Hobby 2000 MIG-15 kits
<http://mek.kosmo.cz/newware>

INCLUDES ALSO WINDOWS
INNER SIDE AND CAMOUFLAGE
DETAILS MASKS

tom.nwkits@seznam.cz

Important:

Let the sprayed color dry before applying masks. Remove masks very carefully after painting.
Where the mask is divided into A and B parts, first apply part A, next part B.
The set does not include masks for all areas, so mask the rest with masking tape or liquid mask.

K kit part

^ start placing the mask from this point

Placing wet masks on wet surface is recommended, except those marked by **W**

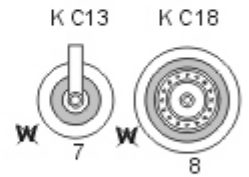
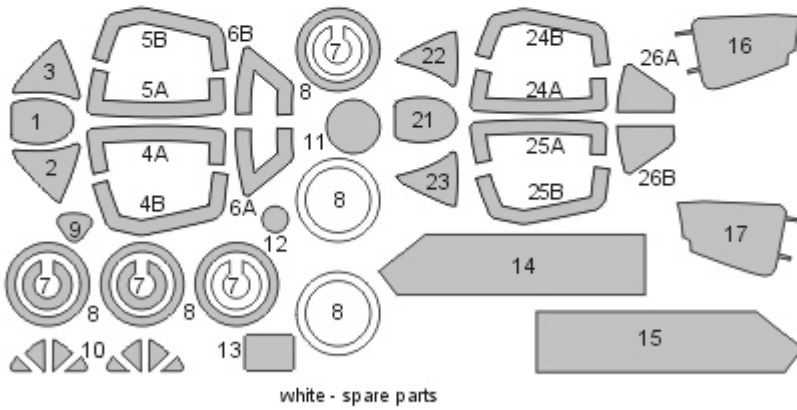

STEP 1 - exterior view
mask interior, paint interior color

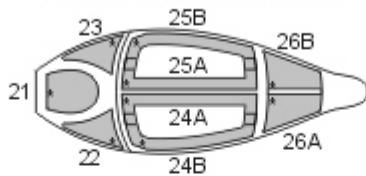

STEP 2
mask exterior, paint camouflage color

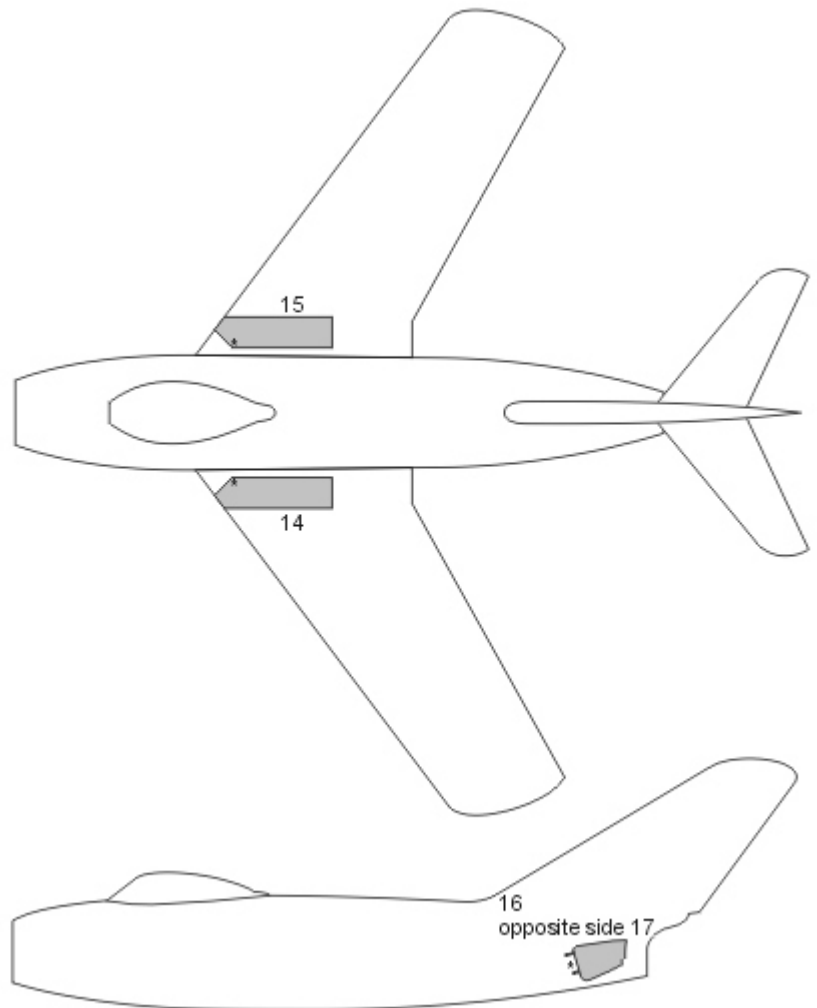
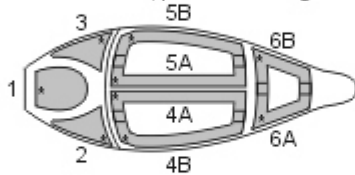



AH-64D (Block II) Apache BASIC kabuki masks
 for ALL Academy and AFV Club AH-64D (Block II) kits
<http://mek.kosmo.cz/newware>

tom.nwkits@seznam.cz

Important:

Let the sprayed color dry before applying masks. Remove masks very carefully after painting.
 Where the mask is divided into A and B parts, first apply part A, next part B.
 The set does not include masks for all areas, so mask the rest with masking tape or liquid mask.
 K kit part
 ^ start placing the mask from this point
 Placing wet masks on wet surface is recommended, except those marked by **W**

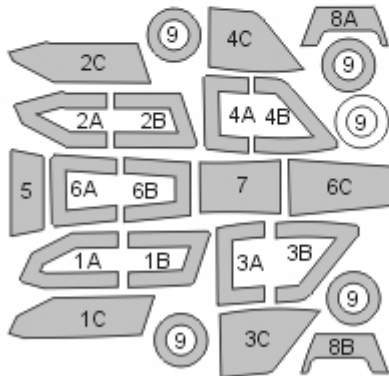

white - spare parts

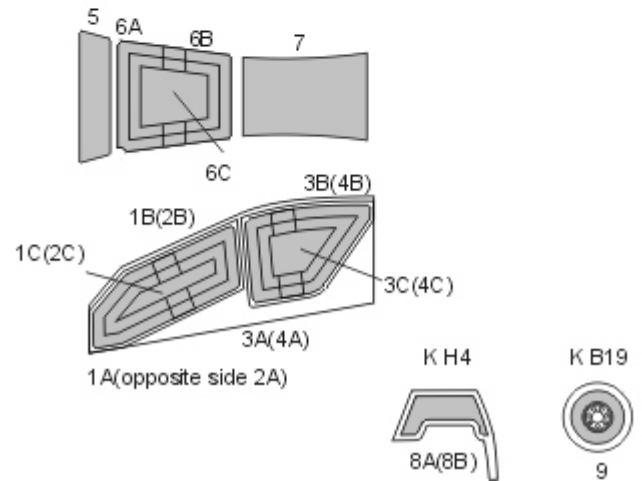



NWAM1060

AH-64D (Block II) Apache ADVANCED kabuki masks
for ALL Academy and AFV Club AH-64D (Block II) kits
<http://mek.kosmo.cz/newware>

INCLUDES ALSO WINDOWS
SEAL AND CAMOUFLAGE
DETAILS MASKS

1/72 scale

tom.nwkits@seznam.cz

Important:

Let the sprayed color dry before applying masks. Remove masks very carefully after painting.
Where the mask is divided into A and B parts, first apply part A, next part B.
The set does not include masks for all areas, so mask the rest with masking tape or liquid mask.

K kit part

* start placing the mask from this point

Placing wet masks on wet surface is recommended, except those marked by **W**

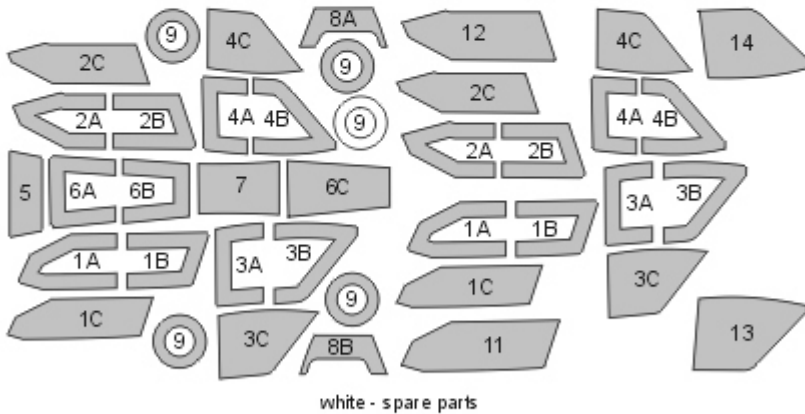

STEP 1 paint interior color

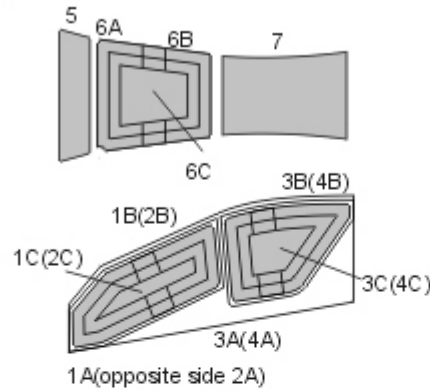

STEP 2 paint seal color

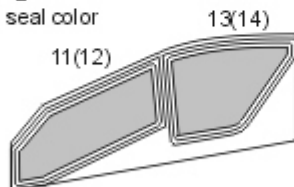

STEP 3 paint camouflage color

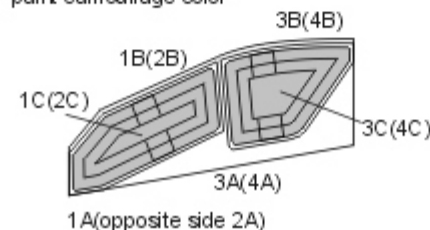



NWAM1061

AH-64D (Block II) Apache EXPERT kabuki masks
 for ALL Academy and AFV Club AH-64D (Block II) kits
<http://mek.kosmo.cz/newware>

INCLUDES ALSO WINDOWS
 SEAL AND INNER SIDE AND
 CAMOUFLAGE DETAILS MASKS

1/72 scale

tom.nwkits@seznam.cz

Important:

Let the sprayed color dry before applying masks. Remove masks very carefully after painting.
 Where the mask is divided into A and B parts, first apply part A, next part B.
 The set does not include masks for all areas, so mask the rest with masking tape or liquid mask.

K kit part

* start placing the mask from this point

Placing wet masks on wet surface is recommended, except those marked by **W**

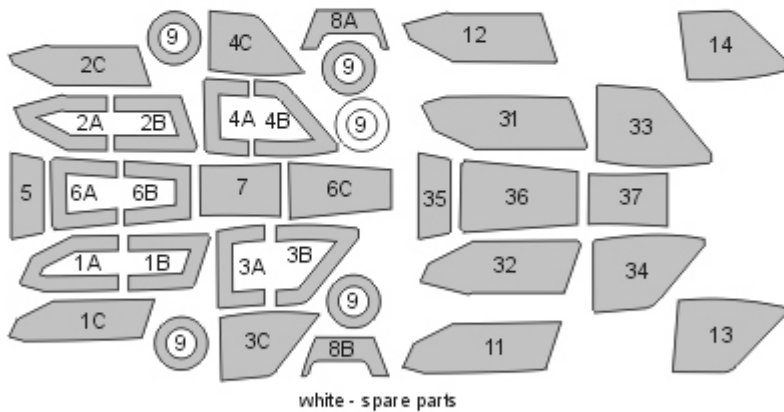

STEP 1 - exterior view

mask interior, paint interior color

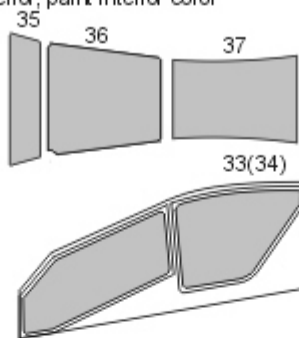

STEP 2

mask exterior, paint seal color

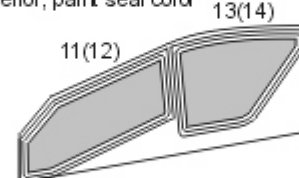

STEP 3

mask exterior, paint camouflage color

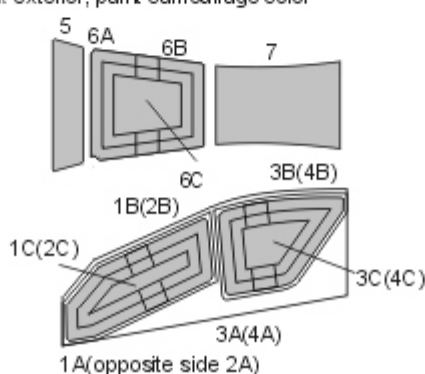



MIL MI-8MT BASIC kabuki masks

for Zvezda No. 4828 kit

<http://mek.kosmo.cz/newware>

tom.nwkits@seznam.cz

Important:

Let the sprayed color dry before applying masks. Remove masks very carefully after painting.
 Where the mask is divided into A and B parts, first apply part A, next part B.
 The set does not include masks for all areas, so mask the rest with masking tape or liquid mask.

K kit part

^ start placing the mask from this point

Placing wet masks on wet surface is recommended, except those marked by **W**

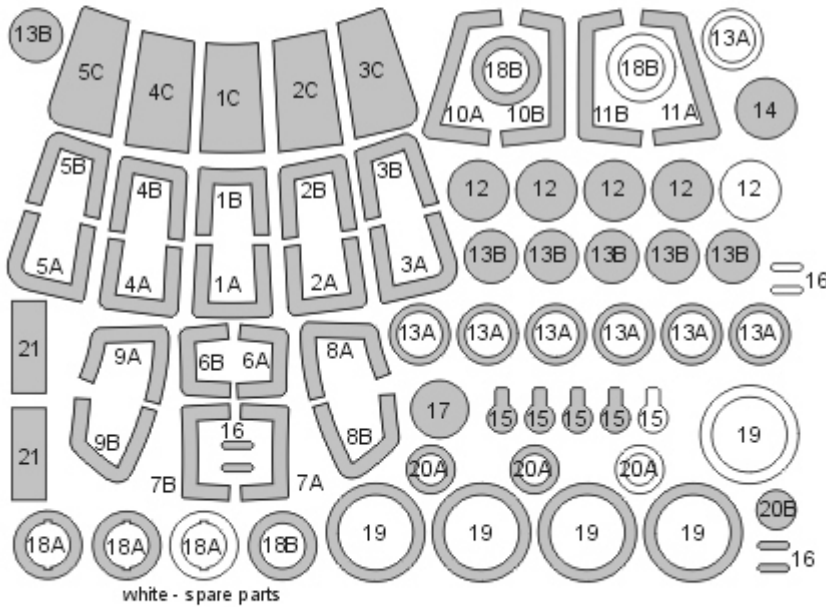

white - spare parts

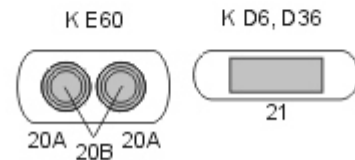
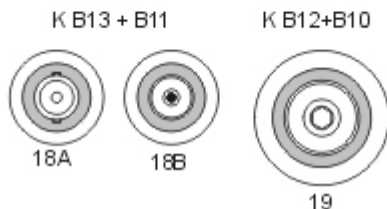
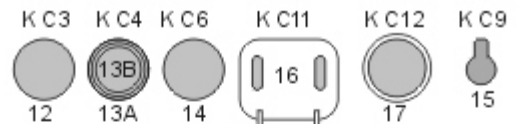
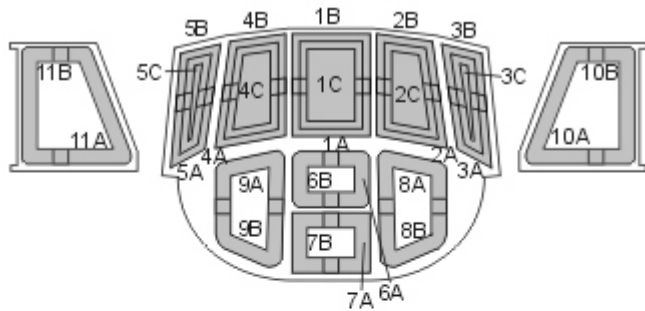

NWAM1063

1/48 scale



MIL MI-8MT EXPERT kabuki masks

for Zvezda No. 4828 kit

<http://mek.kosmo.cz/newware>

INCLUDES ALSO WINDOWS
INNER SIDE MASKS

tom.nwkits@seznam.cz

Important:

Let the sprayed color dry before applying masks. Remove masks very carefully after painting.
Where the mask is divided into A and B parts, first apply part A, next part B.
The set does not include masks for all areas, so mask the rest with masking tape or liquid mask.

K kit part

* start placing the mask from this point

Placing wet masks on wet surface is recommended, except those marked by **W**

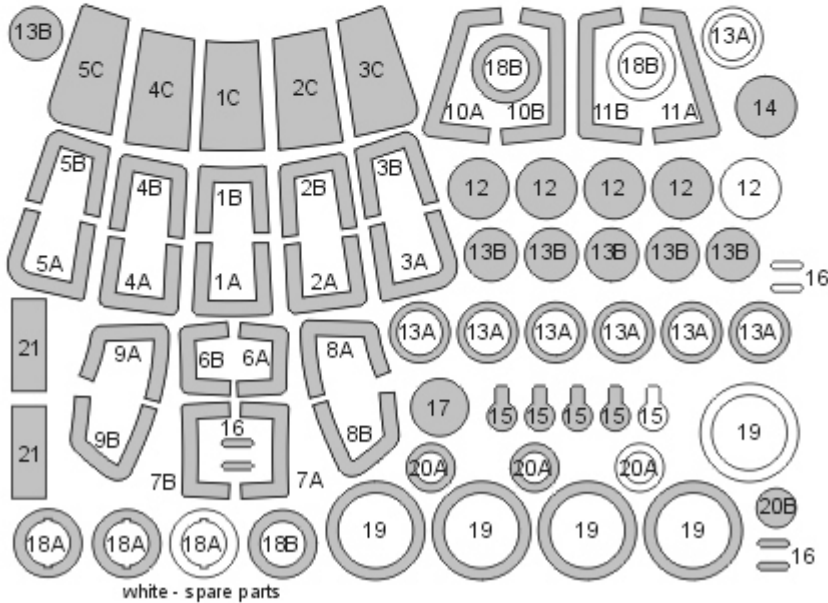

white - spare parts

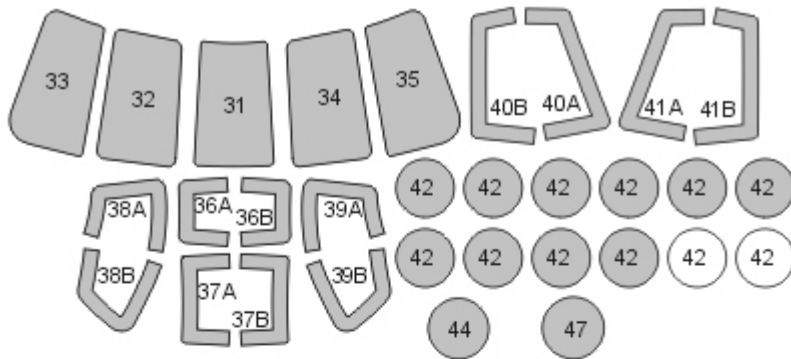

STEP 1 - exterior view
mask interior, paint interior color

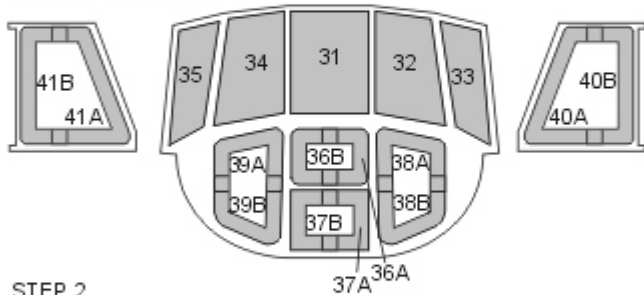

STEP 2
mask exterior, paint camouflage color

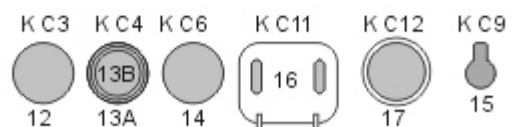
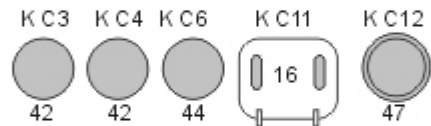
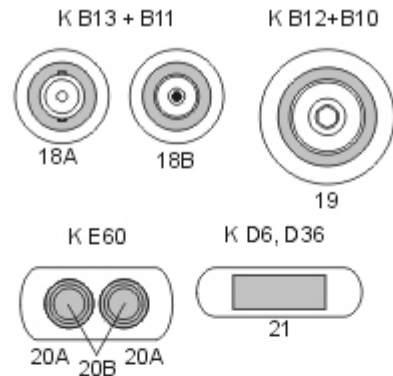
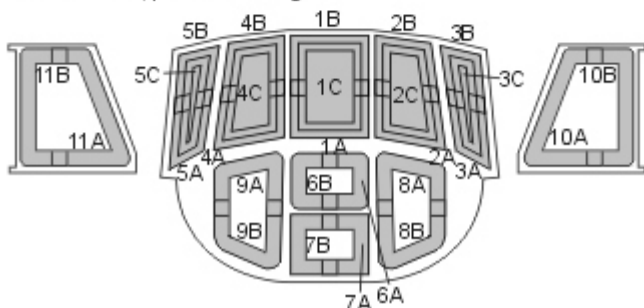

NWAM1064

1/72 scale



CH-53D BASIC kabuki masks

for Academy kit no. 12575

<http://mek.kosmo.cz/newware>

tom.nwkits@seznam.cz

Important:

Let the sprayed color dry before applying masks. Remove masks very carefully after painting.

Where the mask is divided into A and B parts, first apply part A, next part B.

The set does not include masks for all areas, so mask the rest with masking tape or liquid mask.

K kit part

* start placing the mask from this point

Placing wet masks on wet surface is recommended, except those marked by **W**

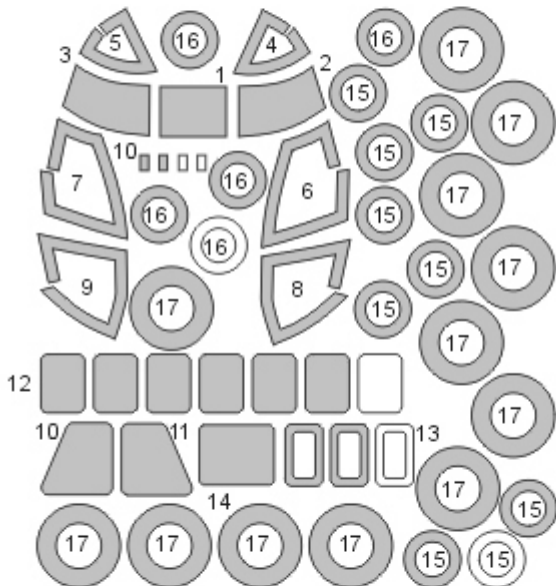

white - spare masks

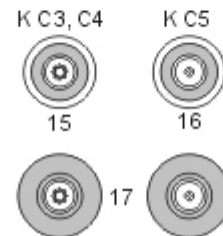
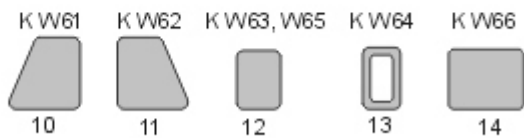
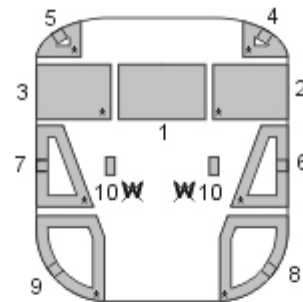

NWAM1065

1/72 scale



CH-53D EXPERT kabuki masks

for Academy kit no. 12575

<http://mek.kosmo.cz/newware>

INCLUDES ALSO WINDOWS INNER SIDE, AND CAMOUFLAGED DETAILS MASKS

tom.nwkits@seznam.cz

Important:

Let the sprayed color dry before applying masks. Remove masks very carefully after painting.

Where the mask is divided into A and B parts, first apply part A, next part B.

The set does not include masks for all areas, so mask the rest with masking tape or liquid mask.

K kit part

* start placing the mask from this point

Placing wet masks on wet surface is recommended, except those marked by **W**

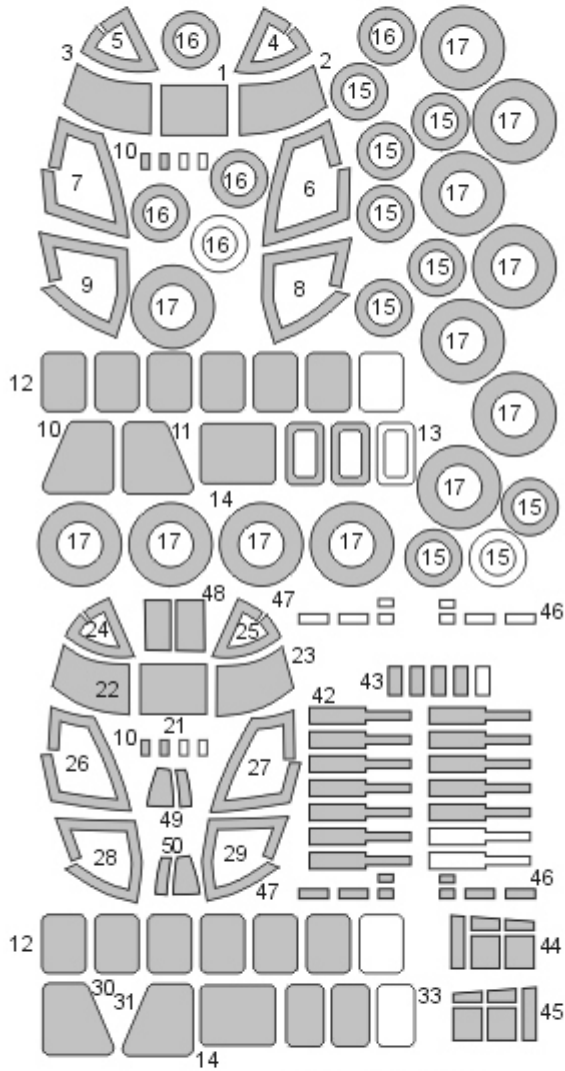

white - spare masks

STEP 1 - exterior view mask interior, paint interior color

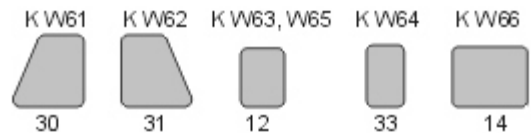
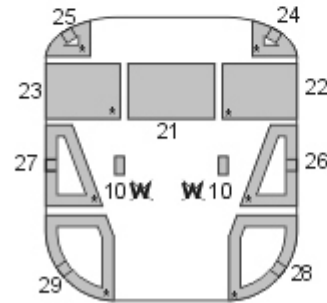

STEP 2 mask exterior, paint camouflage color

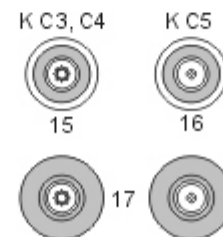
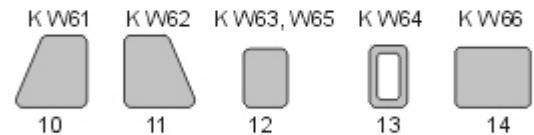
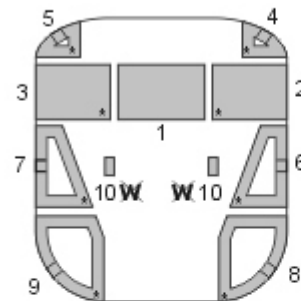

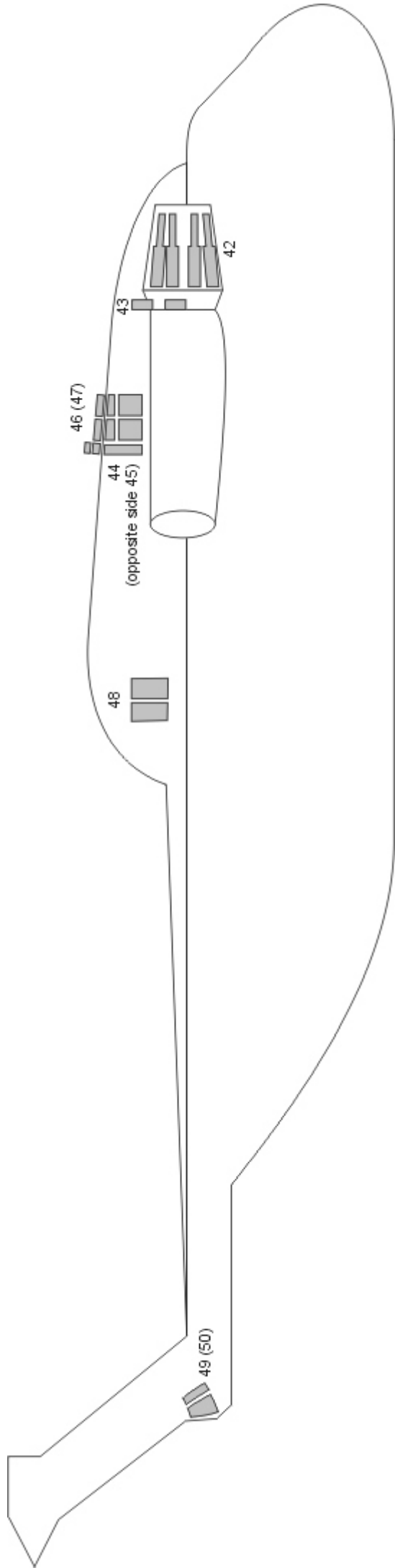



F-86F Sabre BASIC kabuki masks

for ALL Fujimi F-86F kits and Italeri no. 1426 kit

<http://mek.kosmo.cz/newware>

tom.nwkits@seznam.cz

Important:

Let the sprayed color dry before applying masks. Remove masks very carefully after painting.

Where the mask is divided into A and B parts, first apply part A, next part B.

The set does not include masks for all areas, so mask the rest with masking tape or liquid mask.

K kit part

^ start placing the mask from this point

Placing wet masks on wet surface is recommended, except those marked by **W**

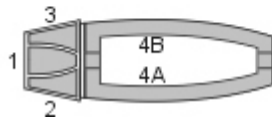
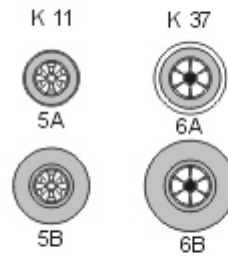
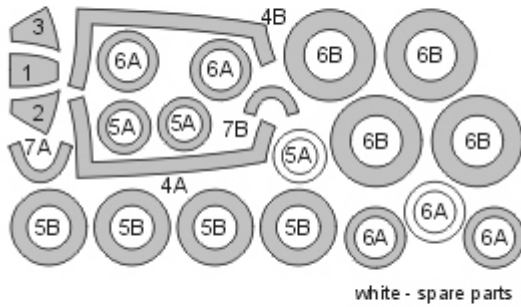



F-86F Sabre ADVANCED kabuki masks
 for ALL Fujimi F-86F kits and Italeri no. 1426 kit
<http://mek.kosmo.cz/newware>

INCLUDES ALSO WINDOWS
 SEAL MASKS

tom.nwkits@seznam.cz

Important:

Let the sprayed color dry before applying masks. Remove masks very carefully after painting.
 Where the mask is divided into A and B parts, first apply part A, next part B.
 The set does not include masks for all areas, so mask the rest with masking tape or liquid mask.

K kit part

* start placing the mask from this point

Placing wet masks on wet surface is recommended, except those marked by **W**

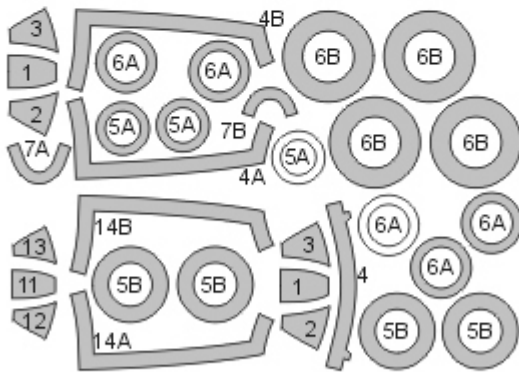

white - spare parts

STEP 1
 paint interior color

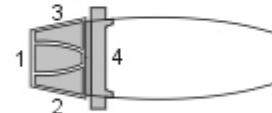

STEP 2
 paint seal color

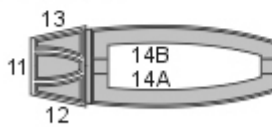

STEP 1
 paint exterior color

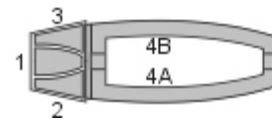

K 11



5A



5B

K 37



6A



6B

NWAM1068



F-86F Sabre EXPERT kabuki masks
 for ALL Fujimi F-86F kits and Italeri no. 1426 kit
<http://mek.kosmo.cz/newware>

INCLUDES ALSO WINDOWS
 SEAL AND INNER SIDE MASKS

1/72 scale

tom.nwkits@seznam.cz

Important:

Let the sprayed color dry before applying masks. Remove masks very carefully after painting.
 Where the mask is divided into A and B parts, first apply part A, next part B.
 The set does not include masks for all areas, so mask the rest with masking tape or liquid mask.

K kit part

^ start placing the mask from this point

Placing wet masks on wet surface is recommended, except those marked by **W**

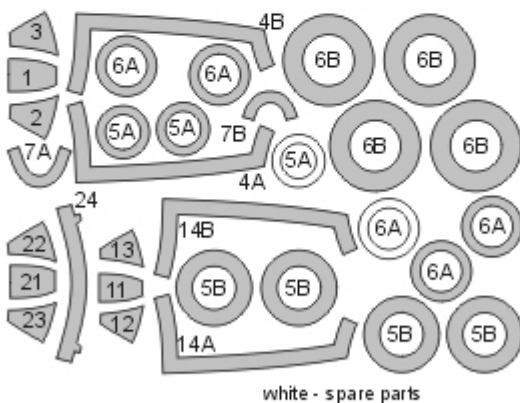

STEP 1 - exterior view
 mask interior, paint interior color

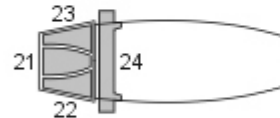

STEP 2
 mask exterior, paint seal color

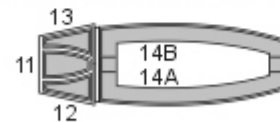

STEP 1
 mask exterior, paint exterior color

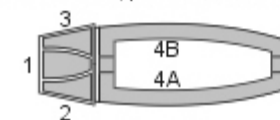



IL-2 Shturmovik mod. 1943 BASIC kabuki masks

for ZVEZDA no. 4826 kit

<http://mek.kosmo.cz/newware>

tom.nwkits@seznam.cz

Important:

Let the sprayed color dry before applying masks. Remove masks very carefully after painting.
Where the mask is divided into A and B parts, first apply part A, next part B.
The set does not include masks for all areas, so mask the rest with masking tape or liquid mask.

K kit part

^ start placing the mask from this point

Placing wet masks on wet surface is recommended, except those marked by **W**

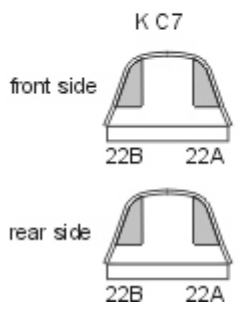
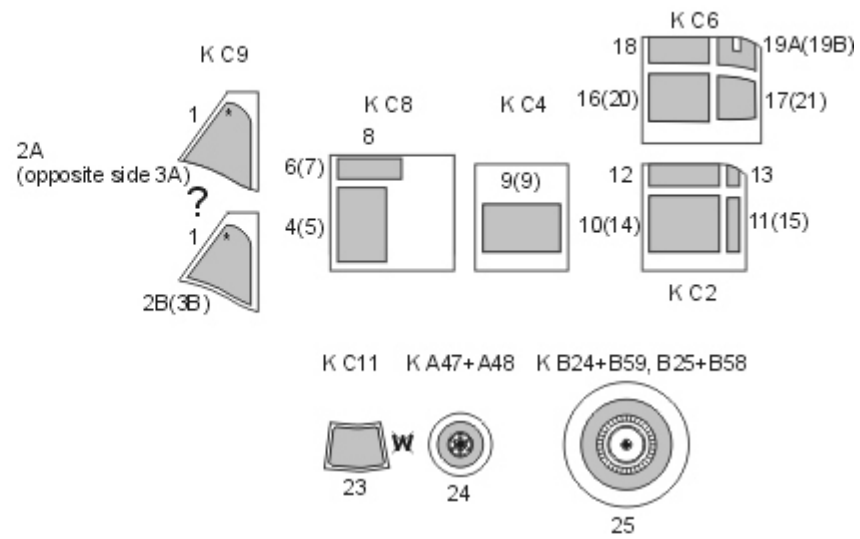
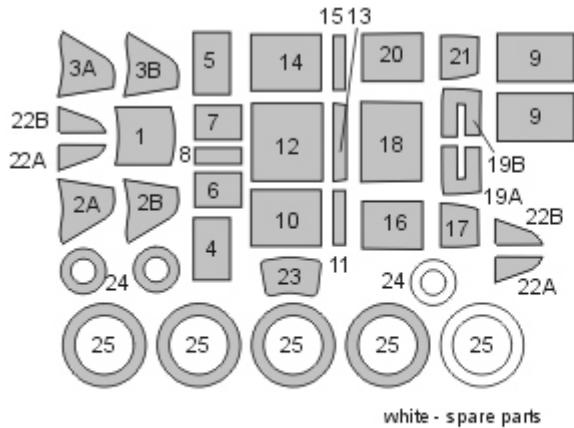



IL-2 Shturmovik mod. 1943 EXPERT kabuki masks

for ZVEZDA no. 4826 kit

<http://mek.kosmo.cz/newware>

INCLUDES ALSO WINDOWS
INNER SIDE MASKS

tom.nwkits@seznam.cz

Important:

Let the sprayed color dry before applying masks. Remove masks very carefully after painting.
Where the mask is divided into A and B parts, first apply part A, next part B.
The set does not include masks for all areas, so mask the rest with masking tape or liquid mask.

K kit part

^ start placing the mask from this point

Placing wet masks on wet surface is recommended, except those marked by **W**

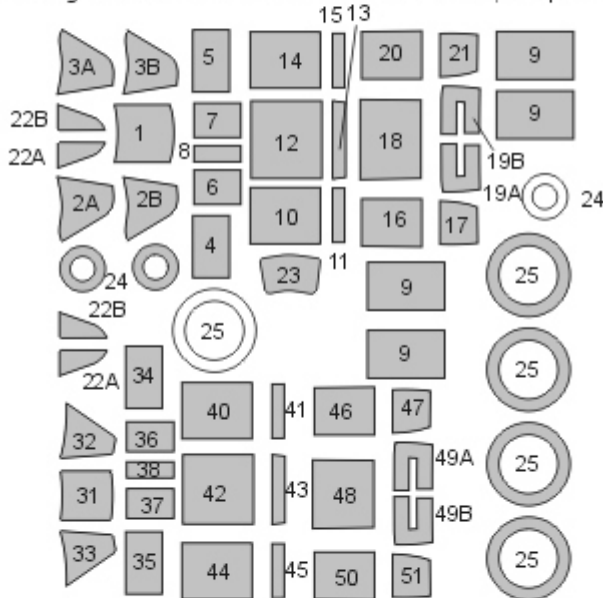

white - spare parts



K C 11 K A 47+A 48 K B 24+B 59, B 25+B 58

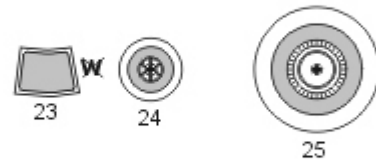

STEP 1 - exterior view
mask interior, paint interior color

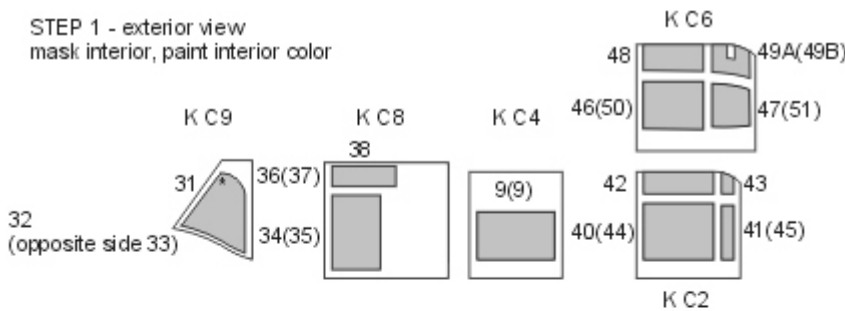

STEP 2
mask exterior, paint camouflage color

