



NEW WARE NEWSLETTER

NEW MASKS JANUARY 2023

NWAM1049 1/48 B-17F Fly ing Fortres s BASIC kabuki mask s
NWAM1050 1/48 B-17F Fly ing Fortres s EXPERT kabuki m asks
NWAM1051 1/48 B-17F Fly ing Fortres s CAMOUFLA GE DETAILS kabuk i mask s
NWAM1052 1/72 F-104 A/C/ G Starfighter BASIC kabuk i mask s
NWAM1053 1/72 F-104 A/C/ G Starfighter ADVANCED kabuki mas ks
NWAM1054 1/72 F-104 A/C/ G Starfighter EXPERT kabuki mask s
NWAM1055 1/32 AH-1G Cobra BASIC kabuk i mask s
NWAM1056 1/32 AH-1G Cobra EXPERT kabuki mask s



B-17F Flying Fortress BASIC kabuki masks

for HK Models 01F002 kit

<http://mek.kosmo.cz/newware>

tom.nwkits@seznam.cz

Use also NWAM1051 B-17F camouflage details masks

Important:

Let the sprayed color dry before applying masks. Remove masks very carefully after painting.

Where the mask is divided into A and B parts, first apply part A, next part B.

The set does not include masks for all areas, so mask the rest with masking tape or liquid mask.

K kit part

^ start placing the mask from this point

Placing wet masks on wet surface is recommended, except those marked by **W**

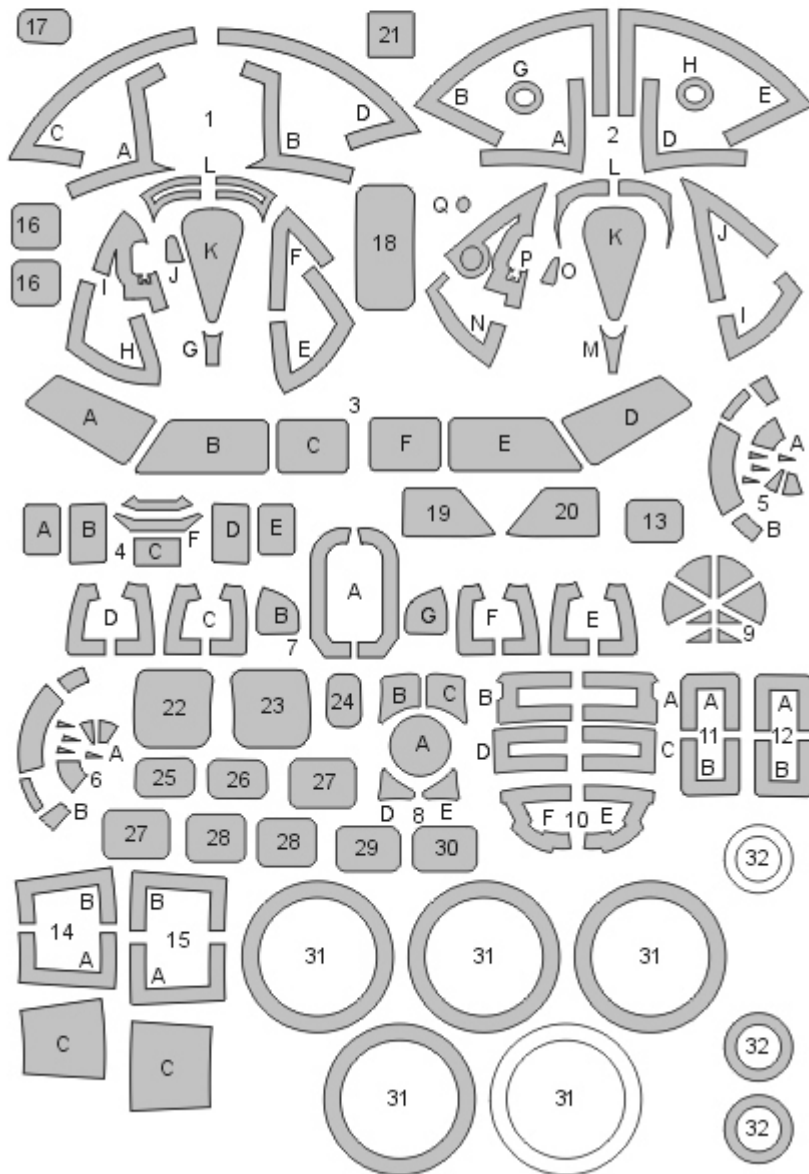

white - spare parts

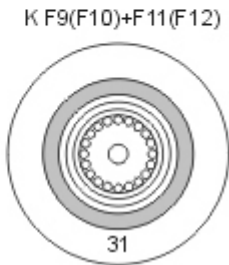
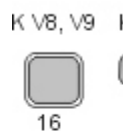
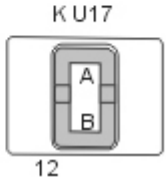
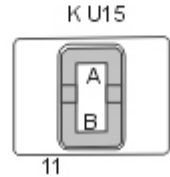
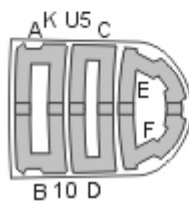
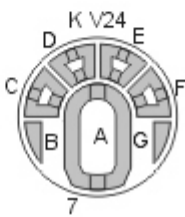
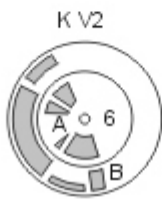
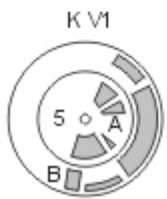
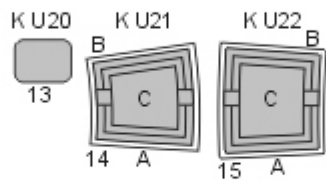
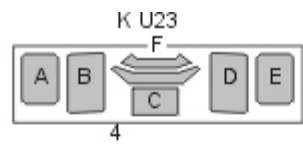
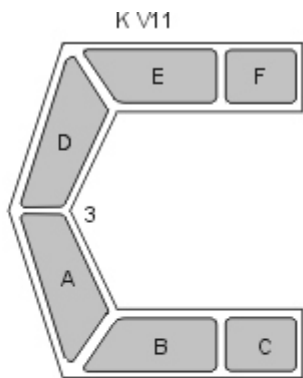



B-17F Flying Fortress EXPERT kabuki masks

for HK Models 01F002 kit

<http://mek.kosmo.cz/newware>

INCLUDES ALSO WINDOWS
INNER SIDE MASKS

tom.nwkits@seznam.cz

Use also NWAM1051 B-17F camouflage details masks

Important:

Let the sprayed color dry before applying masks. Remove masks very carefully after painting.

Where the mask is divided into A and B parts, first apply part A, next part B.

The set does not include masks for all areas, so mask the rest with masking tape or liquid mask.

K kit part

^ start placing the mask from this point

Placing wet masks on wet surface is recommended, except those marked by **W**

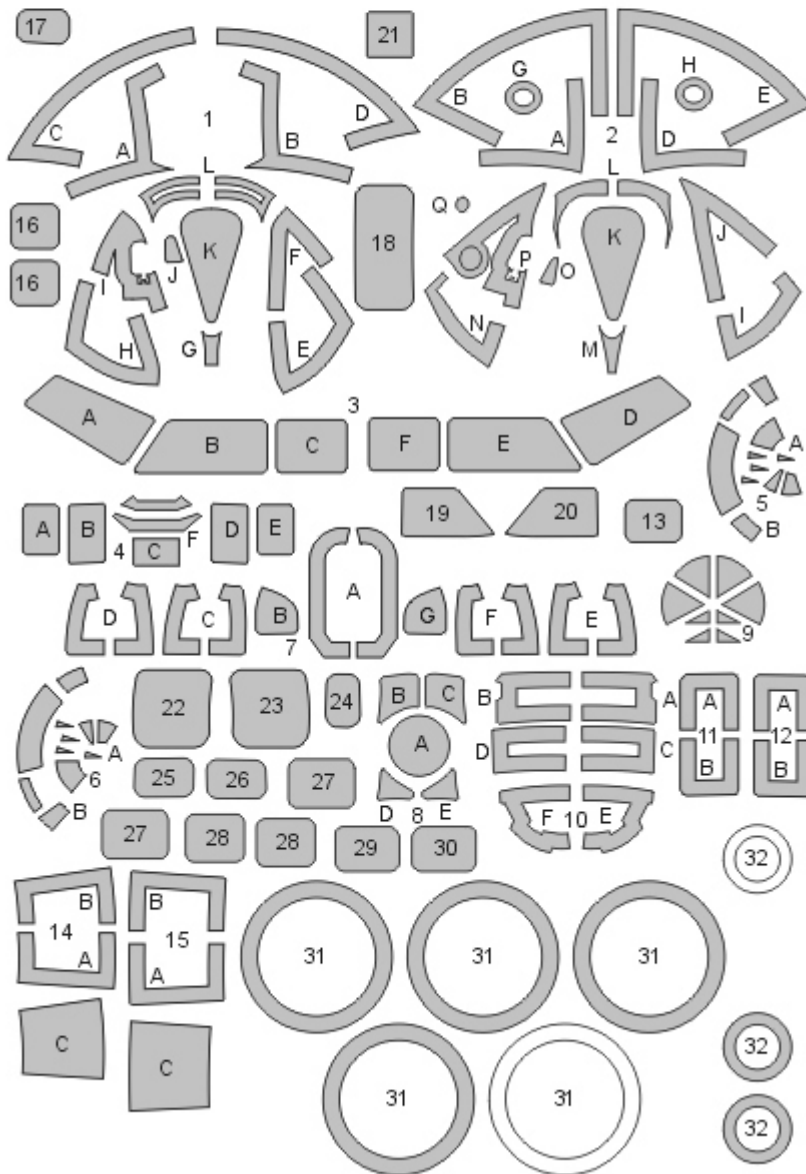

white - spare parts

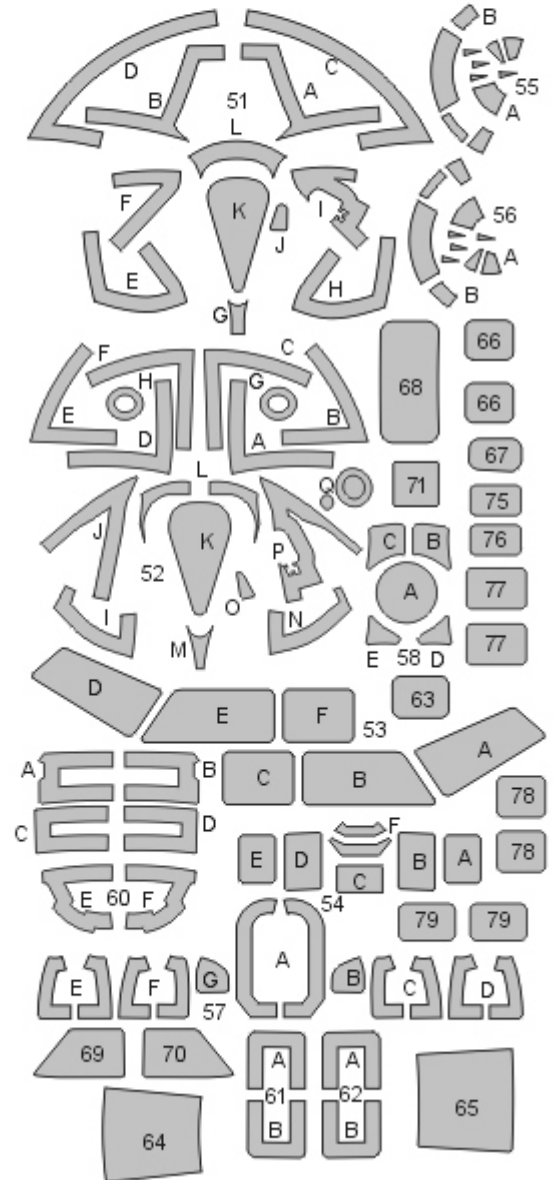

STEP 1 - exterior view
mask interior, paint interior color

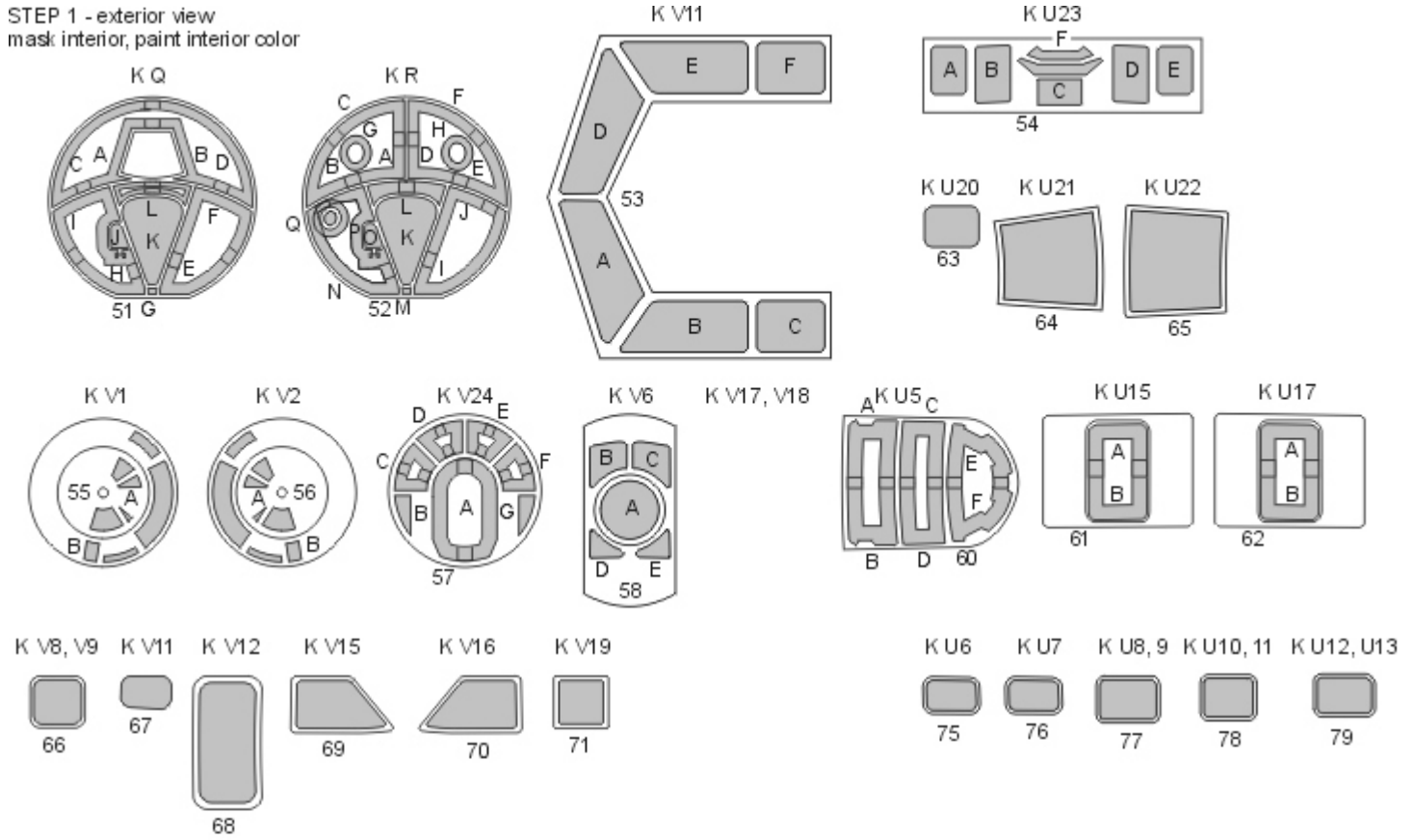

STEP 2
mask exterior, paint camouflage color

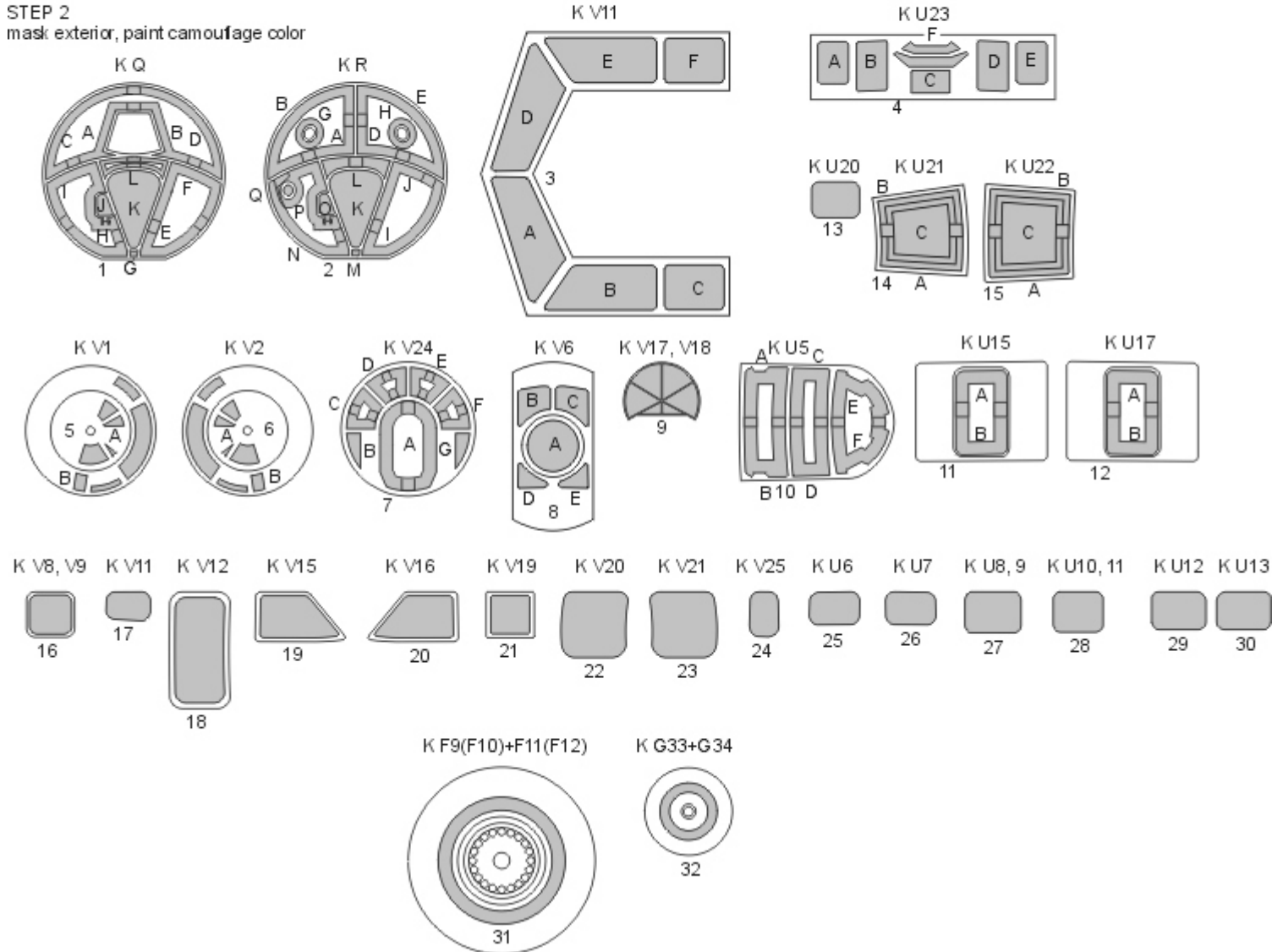



B-17F Flying Fortress CAMOUFLAGE DETAILS kabuki masks

for HK Models 01F002 kit

<http://mek.kosmo.cz/newware>

tom.nwkits@seznam.cz

Use also NWAM1049 or NWAM1050 B-17F masks

Important:

Let the sprayed color dry before applying masks. Remove masks very carefully after painting.

Where the mask is divided into A and B parts, first apply part A, next part B.

The set does not include masks for all areas, so mask the rest with masking tape or liquid mask.

K kit part

* start placing the mask from this point

Placing wet masks on wet surface is recommended, except those marked by **W**

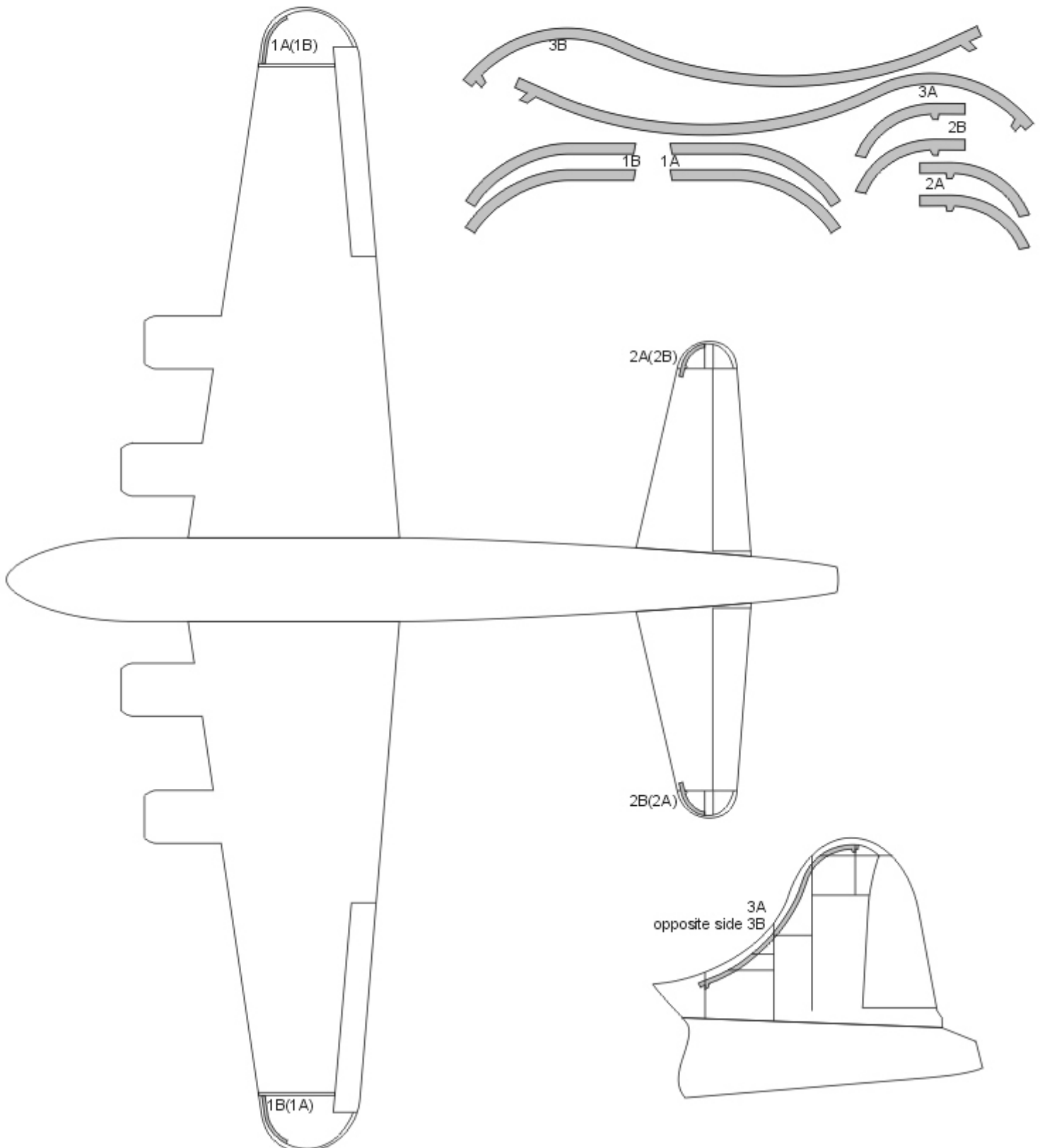



F-104A/C/G Starfighter BASIC kabuki masks

for ALL Italeri and Eschi F-104 Starfighter kits

<http://mek.kosmo.cz/newware>

tom.nwkits@seznam.cz

Important:

Let the sprayed color dry before applying masks. Remove masks very carefully after painting.

Where the mask is divided into A and B parts, first apply part A, next part B.

The set does not include masks for all areas, so mask the rest with masking tape or liquid mask.

K kit part

^ start placing the mask from this point

Placing wet masks on wet surface is recommended, except those marked by **W**

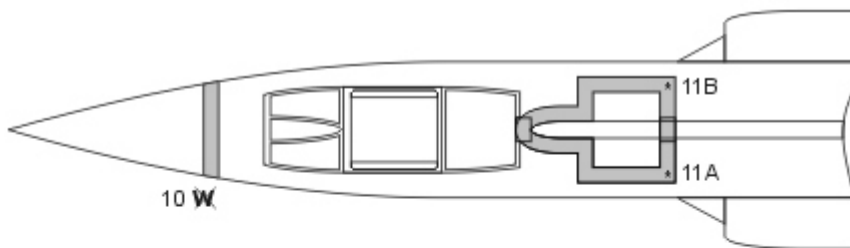
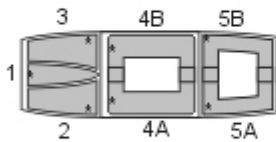
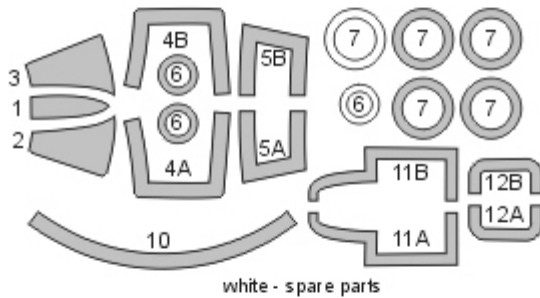

paint white
place mask 10
paint camouflage color

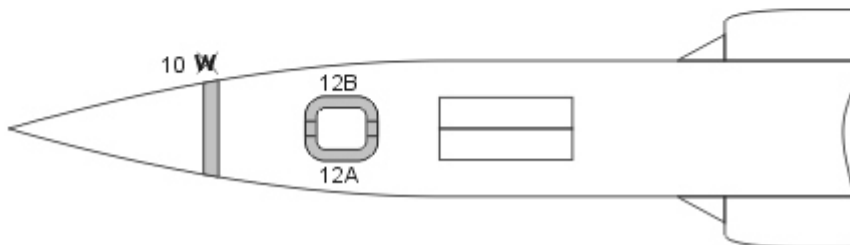



F-104A/C/G Starfighter ADVANCED kabuki masks

for ALL Italeri and Eschi F-104 Starfighter kits

<http://mek.kosmo.cz/newware>

INCLUDES ALSO WINDOWS
SEAL MASKS

tom.nwkits@seznam.cz

Important:

Let the sprayed color dry before applying masks. Remove masks very carefully after painting.
Where the mask is divided into A and B parts, first apply part A, next part B.
The set does not include masks for all areas, so mask the rest with masking tape or liquid mask.

K kit part

^ start placing the mask from this point

Placing wet masks on wet surface is recommended, except those marked by **W**

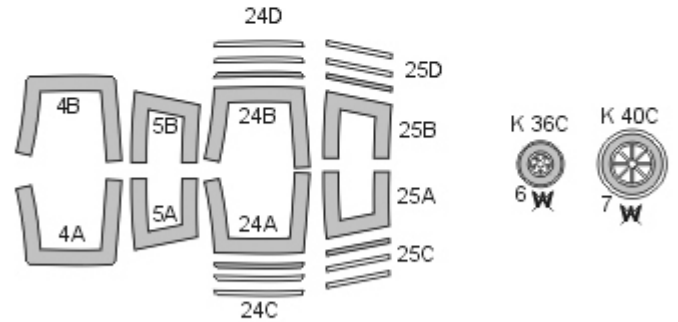
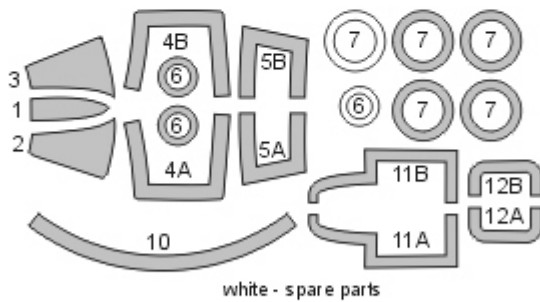

STEP 1

mask exterior, paint interior color

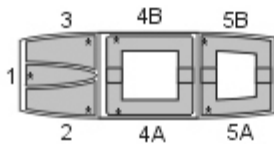

STEP 2

mask exterior

let masks 1,2,3
from previous
step in place

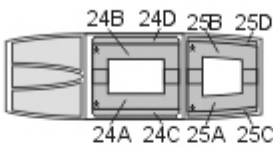

STEP 3

remove masks 24C,D and 25C,D, paint seal color

let masks 1,2,3
from previous
step in place

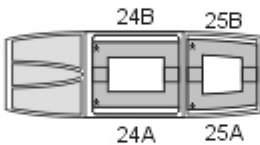

STEP 4

mask exterior, paint camouflage color

let masks 1,2,3
from previous
step in place

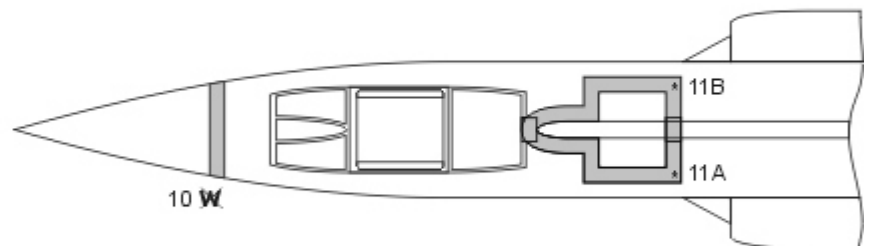
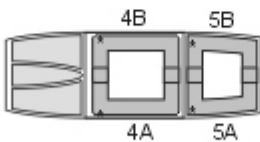

paint white
place mask 10
paint camouflage color

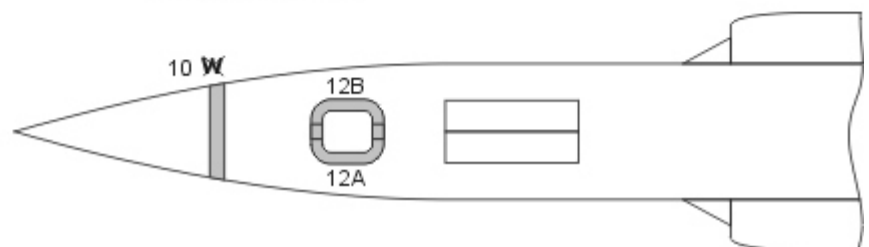

NWAM1054

1/72 scale



F-104A/C/G Starfighter EXPERT kabuki masks
for ALL Italeri and Eschi F-104 Starfighter kits
<http://mek.kosmo.cz/newware>

INCLUDES ALSO WINDOWS
SEAL AND INNER SIDE MASKS

tom.nwkits@seznam.cz

Important:

Let the sprayed color dry before applying masks. Remove masks very carefully after painting.
Where the mask is divided into A and B parts, first apply part A, next part B.
The set does not include masks for all areas, so mask the rest with masking tape or liquid mask.
K kit part
^ start placing the mask from this point
Placing wet masks on wet surface is recommended, except those marked by **W**

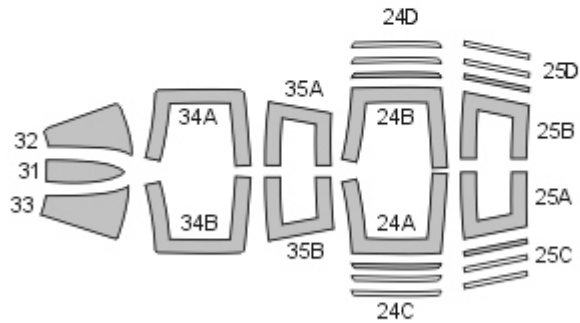
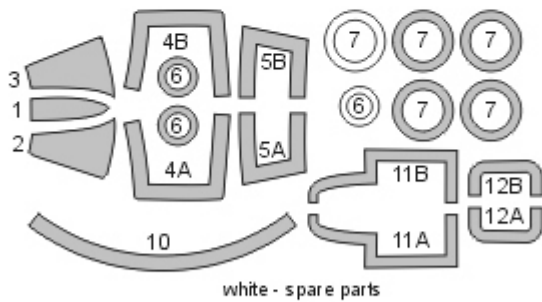

STEP 1 - exterior view
mask interior, paint interior color

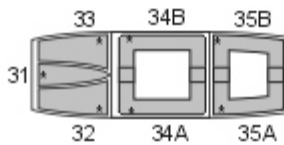

STEP 2
mask exterior

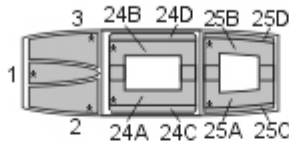

STEP 3
remove masks 24C,D and 25C,D, paint seal color

let masks 1,2,3
from previous
step in place

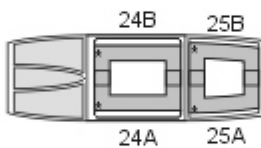

STEP 4
mask exterior, paint camouflage color

let masks 1,2,3
from previous
step in place

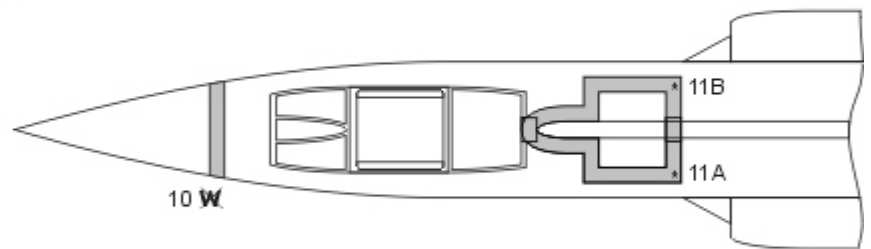
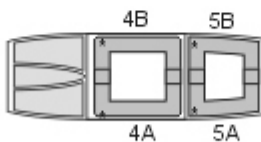

paint white
place mask 10
paint camouflage color

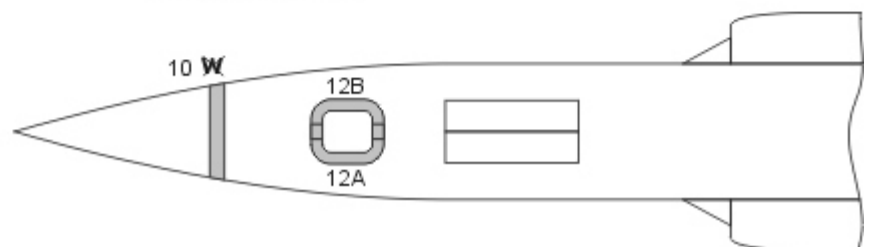

NWAM1055

1/32 scale



AH-1G Cobra BASIC kabuki masks

for Revell 03821 and Special Hobby SH32082, SH32086 kits

<http://mek.kosmo.cz/newware>

tom.nwkits@seznam.cz

Important:

Let the sprayed color dry before applying masks. Remove masks very carefully after painting.

Where the mask is divided into A and B parts, first apply part A, next part B.

The set does not include masks for all areas, so mask the rest with masking tape or liquid mask.

K kit part

* start placing the mask from this point

Placing wet masks on wet surface is recommended, except those marked by **W**

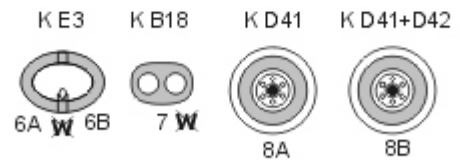
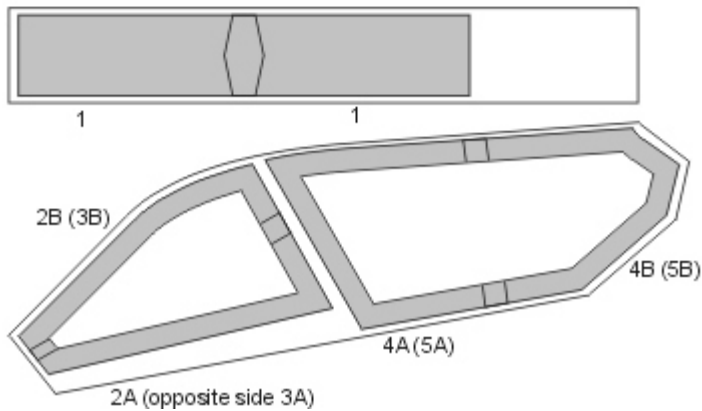
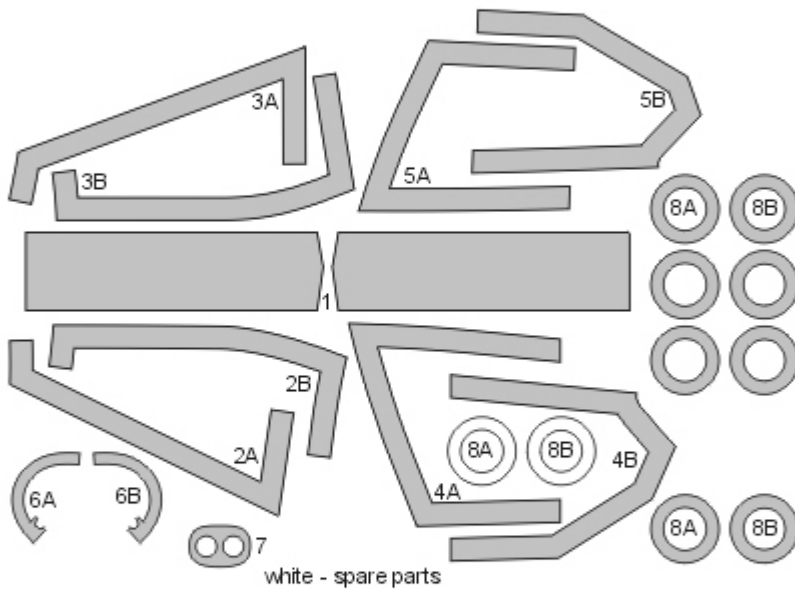

Important:

Let the sprayed color dry before applying masks. Remove masks very carefully after painting.
 Where the mask is divided into A and B parts, first apply part A, next part B.
 The set does not include masks for all areas, so mask the rest with masking tape or liquid mask.
 K kit part
 ^ start placing the mask from this point
 Placing wet masks on wet surface is recommended, except those marked by **W**

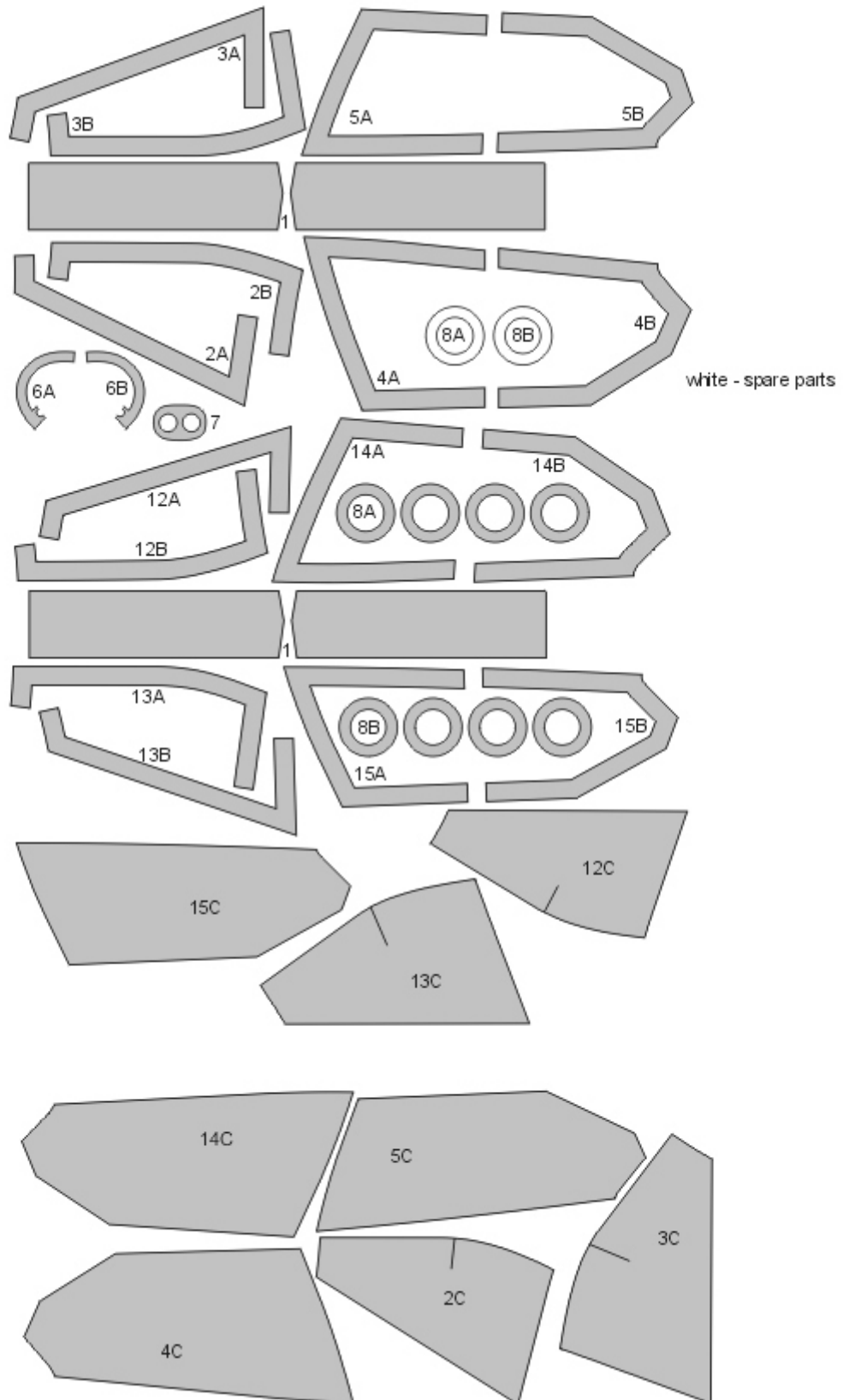

STEP 1 - exterior view
 mask interior, paint interior color

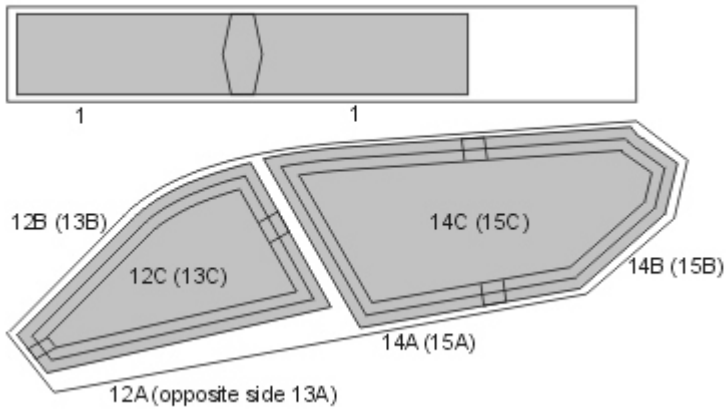

STEP 2
 mask exterior, paint camouflage color

