



# NEW WARE NEWSLETTER

## NEW MASKS APRIL 2026

NWAM 1378 1/ 48 F-16I SUFA BASIC kabuki masks	GW.H
NWAM 1379 1/ 48 F-16I SUFA ADVANCED kabuki masks	GW.H
NWAM 1380 1/ 48 F-16I SUFA EXPERT kabuki masks	GW.H
NWAM 1381 1/ 48 F-16I SUFA EXHAUST NOZZLES kabuki masks	GW.H
NWAM 1382 1/ 72 F-14D Tomcat BASIC kabuki masks	Tamiya
NWAM 1383 1/ 72 F-14D Tomcat EXPERT kabuki masks	Tamiya
NWAM 1384 1/ 48 Focke-Wulf FW 190D-9 BASIC kabuki masks	MiniArt
NWAM 1385 1/ 48 Focke-Wulf FW 190D-9 EXPERT kabuki masks	MiniArt
NWAM 1386 1/ 48 Focke-Wulf FW 190D-9 MARKING kabuki masks	MiniArt
NWAM 1387 1/ 48 HP.52 Hampden B.Mk.I BASIC kabuki masks	ICM
NWAM 1388 1/ 48 HP.52 Hampden B.Mk.I EXPERT kabuki masks	ICM
NWAM 1389 1/ 48 HP.52 Hampden TB.Mk.I BASIC kabuki masks	ICM
NWAM 1390 1/ 48 HP.52 Hampden TB.Mk.I EXPERT kabuki masks	ICM
NWAM 1391 1/ 72 F-86A BASIC kabuki masks	Clear Prop
NWAM 1392 1/ 72 F-86A EXPERT kabuki masks	Clear Prop

# NWAM1378

1/48 scale



F-16I SUFA BASIC kabuki masks

for G.W.H L4835 kit

<http://mek.kosmo.cz/newware>

tom.nwkits@seznam.cz

## USE ALSO NWAM1381 F-16I EXHAUST NOZZLES KABUKI MASKS

### Important:

Let the sprayed color dry before applying masks. Remove masks very carefully after painting.

Where the mask is divided into A and B parts, first apply part A, next part B.

The set does not include masks for all areas, so mask the rest with masking tape or liquid mask.

K kit part

\* start placing the mask from this point

Placing wet masks on wet surface is recommended, except those marked by **W**

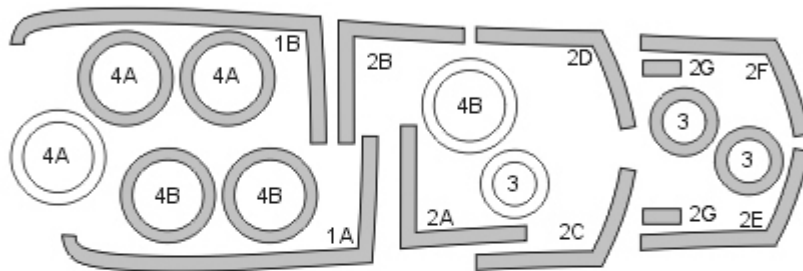

WHITE - SPARE MASKS

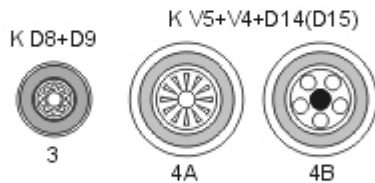

STEP 1  
paint black

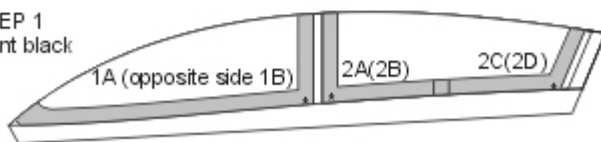

STEP 2  
paint camouflage color

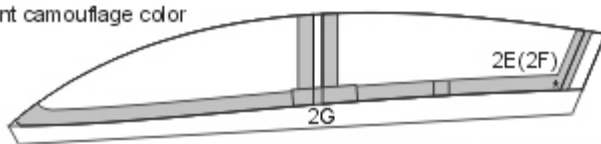

Remove masks 2C and 2D only and replace them by masks 2E and 2F

# NWAM1379

1/48 scale



## F-16I SUFA ADVANCED kabuki masks

for G.W.H L4835 kit

<http://mek.kosmo.cz/newware>

INCLUDES ALSO AIRCRAFT CANOPY SEAL AND SURFACE DETAILS MASKS

tom.nwkits@seznam.cz

### USE ALSO NWAM1381 F-16I EXHAUST NOZZLES KABUKI MASKS

**Important:**

Let the sprayed color dry before applying masks. Remove masks very carefully after painting.

Where the mask is divided into A and B parts, first apply part A, next part B.

The set does not include masks for all areas, so mask the rest with masking tape or liquid mask.

K kit part

\* start placing the mask from this point

Placing wet masks on wet surface is recommended, except those marked by **W**

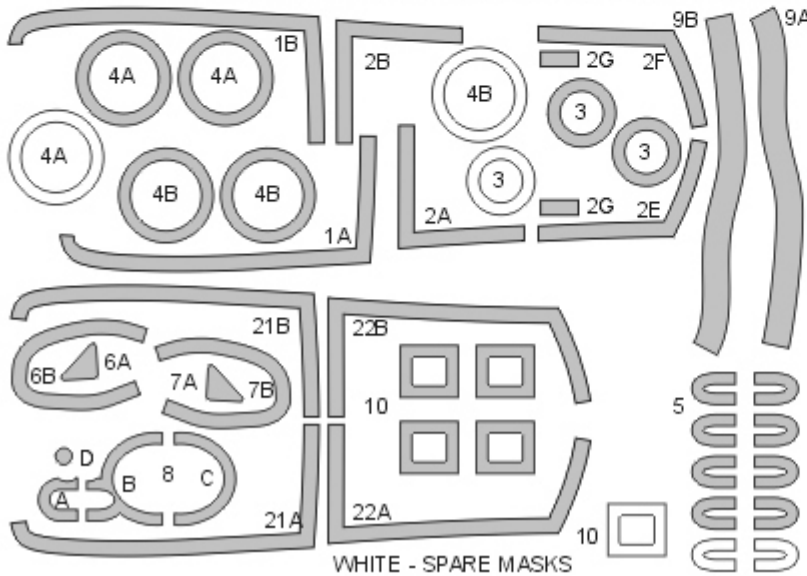

WHITE - SPARE MASKS

STEP 1  
paint black

0,5 mm



thickness of the seal is 0,5 mm

STEP 2  
paint camouflage color

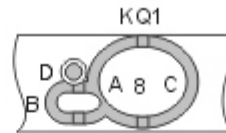
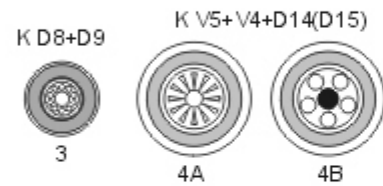
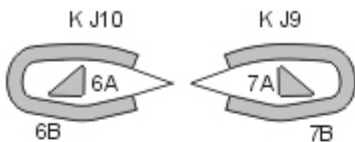
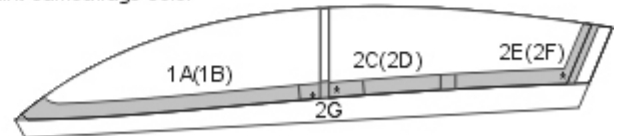

paint exhaust nozzle  
apply masks  
paint camouflage color

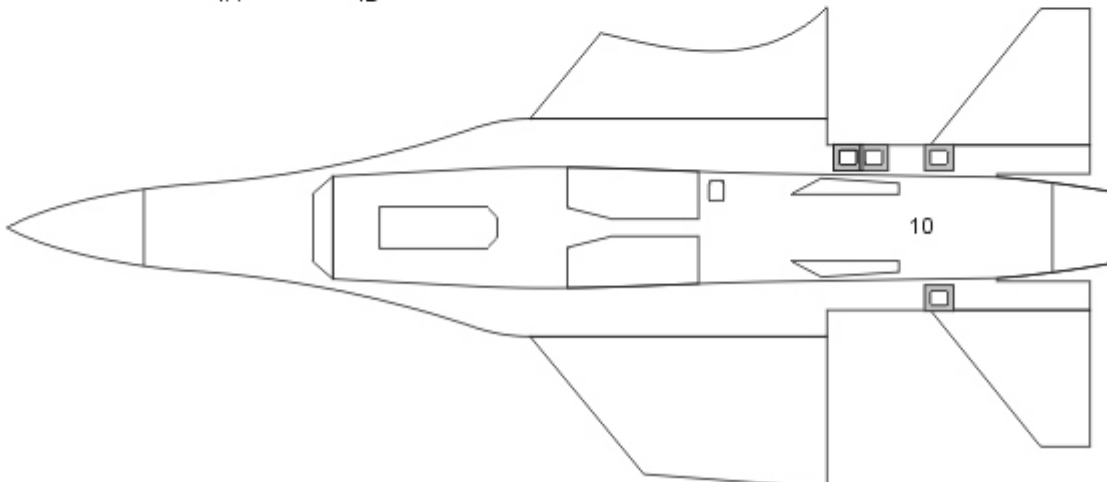
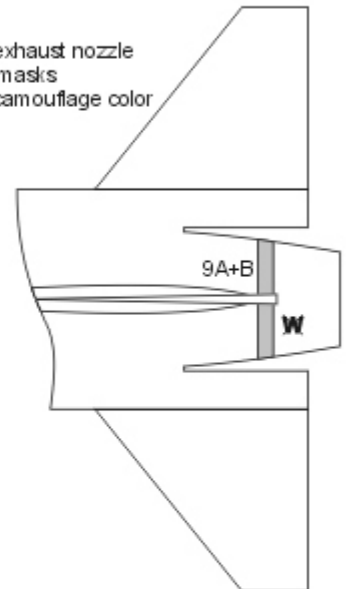
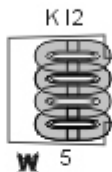

# NWAM1380

1/48 scale



F-16I SUFA EXPERT kabuki masks  
for G.W.H L4835 kit

INCLUDES ALSO AIRCRAFT CANOPY  
SEAL AND INNER SIDE MASKS  
AND SURFACE DETAILS MASKS

[http://mek.kosmo.cz/new\\_ware](http://mek.kosmo.cz/new_ware)

tom.nwkits@seznam.cz

## USE ALSO NWAM1381 F-16I EXHAUST NOZZLES KABUKI MASKS

### Important:

Let the sprayed color dry before applying masks. Remove masks very carefully after painting.  
Where the mask is divided into A and B parts, first apply part A, next part B.

The set does not include masks for all areas, so mask the rest with masking tape or liquid mask.

K kit part

\* start placing the mask from this point

Placing wet masks on wet surface is recommended, except those marked by **W**

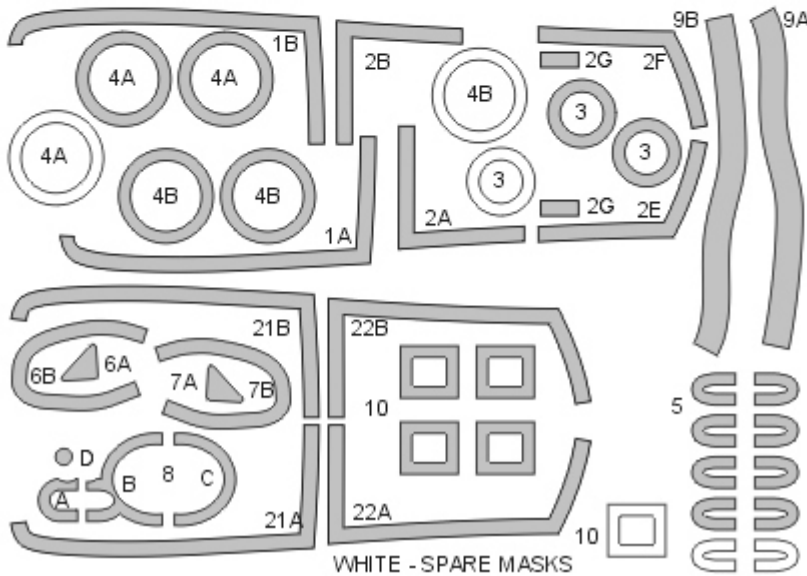

STEP 1 - exterior view  
mask interior, paint black

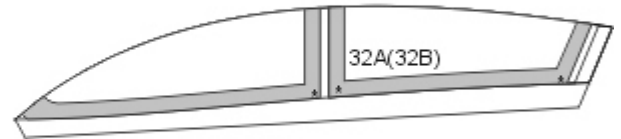

31A (opposite side 31B)

STEP 2  
mask exterior, paint black

0,5 mm

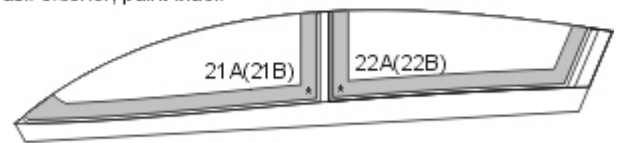

thickness of the seal is 0,5 mm

STEP 3  
mask exterior, paint camouflage color

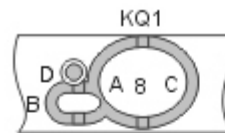
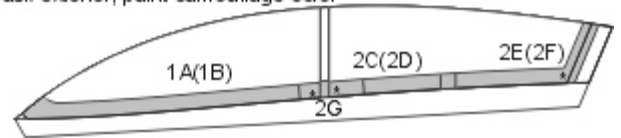

paint exhaust nozzle  
apply masks  
paint camouflage color

K D8+D9



3

K V5+V4+D14(D15)



4A



4B

K I2

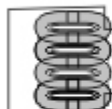

W 5

K J10

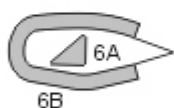

6B

K J9



7B

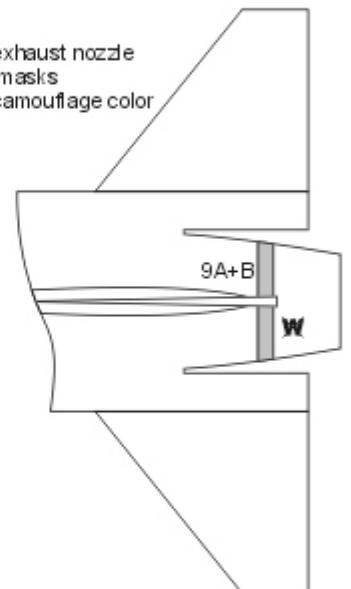
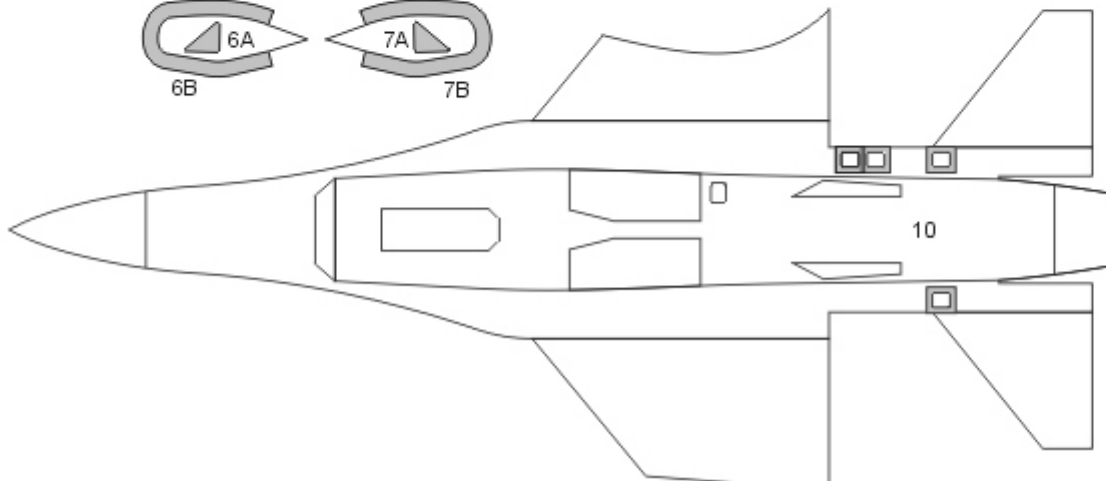

# NWAM1381

1/48 scale



## F-16I SUFA EXHAUST NOZZLE kabuki masks

for G.W.H L4835 kit

<http://mek.kosmo.cz/newware>

[tom.nwkits@seznam.cz](mailto:tom.nwkits@seznam.cz)

### USE ALSO NWAM1378- NWAM1380 F-16I SUFA KABUKI MASKS

**Important:**

Let the sprayed color dry before applying masks. Remove masks very carefully after painting.

Where the mask is divided into A and B parts, first apply part A, next part B.

The set does not include masks for all areas, so mask the rest with masking tape or liquid mask.

K kit part

\* start placing the mask from this point

Placing wet masks on wet surface is recommended, except those marked by **W**

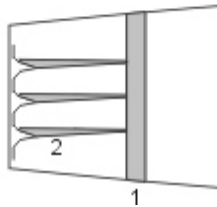
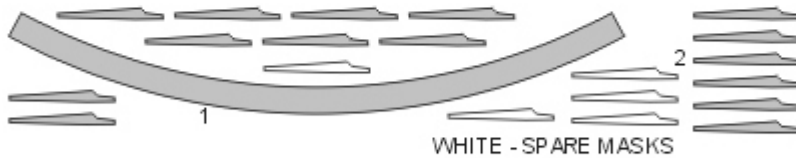



## F-14D Tomcat BASIC kabuki masks

for Tamiya 60795 kit

<http://mek.kosmo.cz/newware>

tom.nwkits@seznam.cz

### Important:

Let the sprayed color dry before applying masks. Remove masks very carefully after painting.

Where the mask is divided into A and B parts, first apply part A, next part B.

The set does not include masks for all areas, so mask the rest with masking tape or liquid mask.

K kit part

\* start placing the mask from this point

Placing wet masks on wet surface is recommended, except those marked by **W**

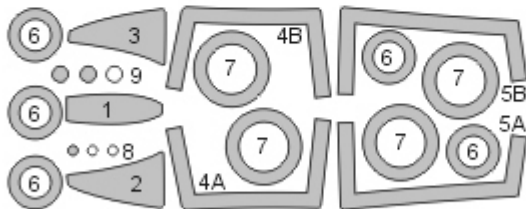

WHITE - SPARE MASKS

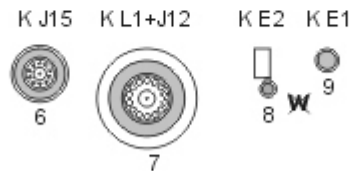



## F-14D Tomcat EXPERT kabuki masks

for Tamiya 60795 kit

<http://mek.kosmo.cz/newware>

INCLUDES ALSO AIRCRAFT CANOPY  
INNER SIDE, SURFACE DETAILS  
AND EXHAUST NOZZLES MASKS

tom.nwkits@seznam.cz

### Important:

Let the sprayed color dry before applying masks. Remove masks very carefully after painting.

Where the mask is divided into A and B parts, first apply part A, next part B.

The set does not include masks for all areas, so mask the rest with masking tape or liquid mask.

K kit part

\* start placing the mask from this point

Placing wet masks on wet surface is recommended, except those marked by **W**

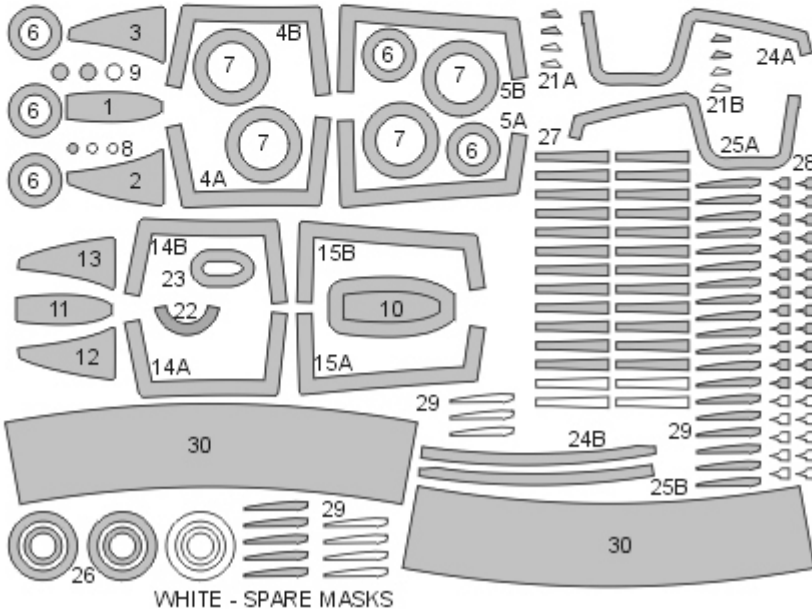

STEP 1 - exterior view  
mask interior, paint clear blue



STEP 2 - exterior view  
mask interior, paint interior color

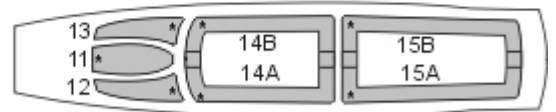

STEP 3  
mask exterior, paint camouflage color

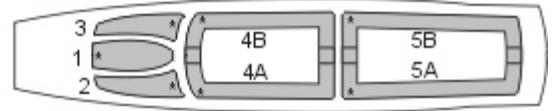

K J15 K L1+J12 K E2 K E1

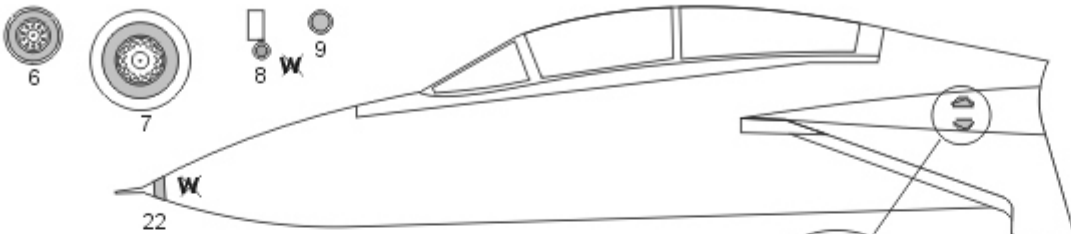

K F9

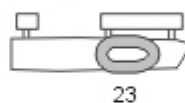

23

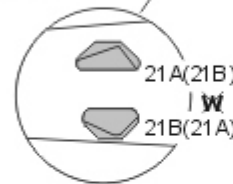

21A(21B)

21B(21A)

K K2



26

K K5

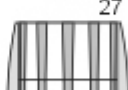

inner side

28 **W**



K G8(G11)



24A(25A) 24B(25B)



29 **W**



30 **W**

# NWAM1384

1/48 scale



FOCKE-WULF FW 190D-9 BASIC kabuki masks

for MiniArt 48040 and derivated kits

<http://mek.kosmo.cz/newware>

[tom.nwkits@seznam.cz](mailto:tom.nwkits@seznam.cz)

## Use also NWAM1386 FOCKE-WULF FW 190D-9 marking masks

### Important:

Let the sprayed color dry before applying masks. Remove masks very carefully after painting.

Where the mask is divided into A and B parts, first apply part A, next part B.

The set does not include masks for all areas, so mask the rest with masking tape or liquid mask.

K kit part

\* start placing the mask from this point

Placing wet masks on wet surface is recommended, except those marked by **W**

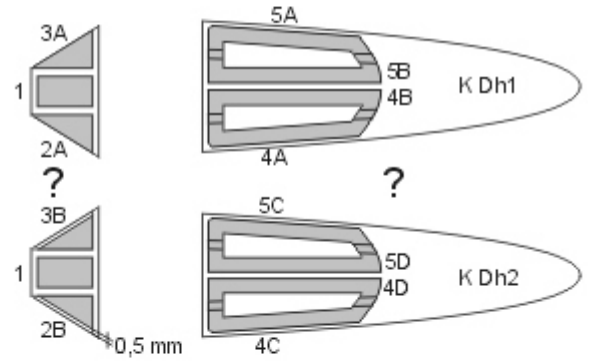
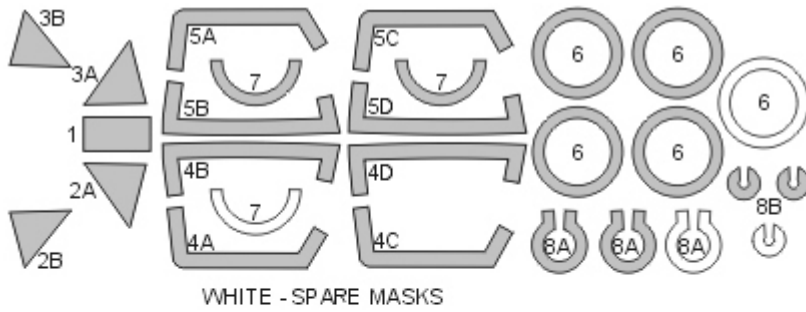

K B6+B5

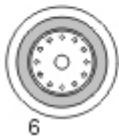

K B18, B19



K B20(B21)



# NWAM1385



FOCKE-WULF FW 190D-9 EXPERT kabuki masks

for MiniArt 48040 and derivated kits

<http://mek.kosmo.cz/newware>

INCLUDES ALSO AIRCRAFT CANOPY  
INNER SIDE MASKS

1/48 scale

tom.nwkits@seznam.cz

## Use also NWAM1386 FOCKE-WULF FW 190D-9 marking masks

### Important:

Let the sprayed color dry before applying masks. Remove masks very carefully after painting.

Where the mask is divided into A and B parts, first apply part A, next part B.

The set does not include masks for all areas, so mask the rest with masking tape or liquid mask.

K kit part

\* start placing the mask from this point

Placing wet masks on wet surface is recommended, except those marked by **W**

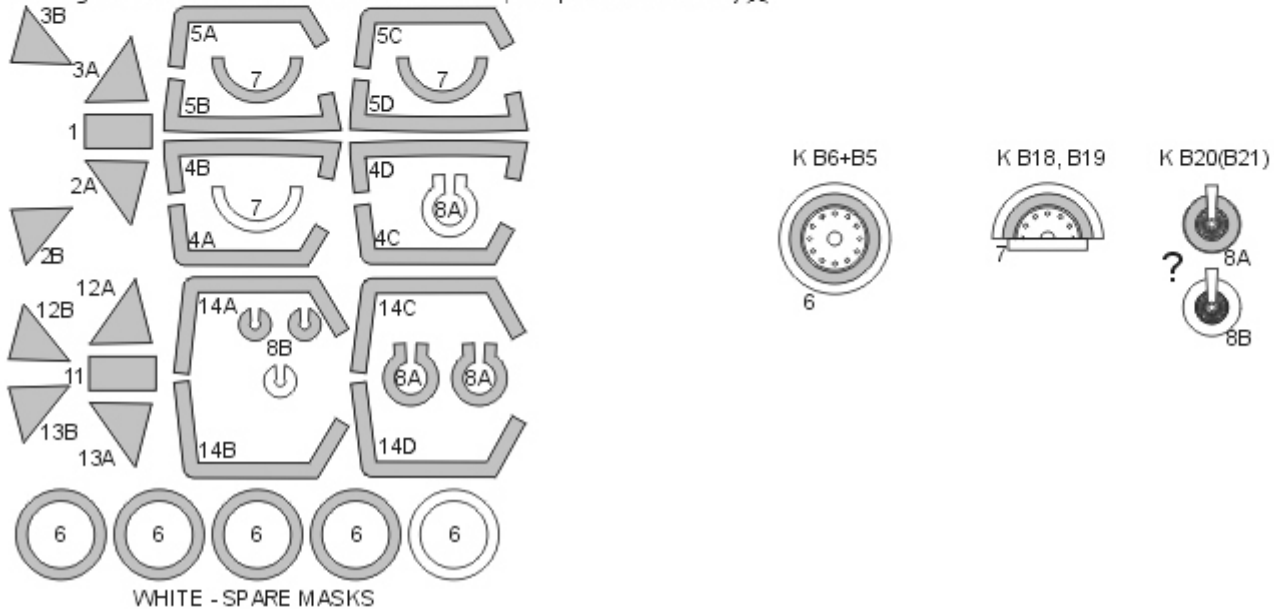

### STEP 1 (exterior view)

mask interior, paint interior color

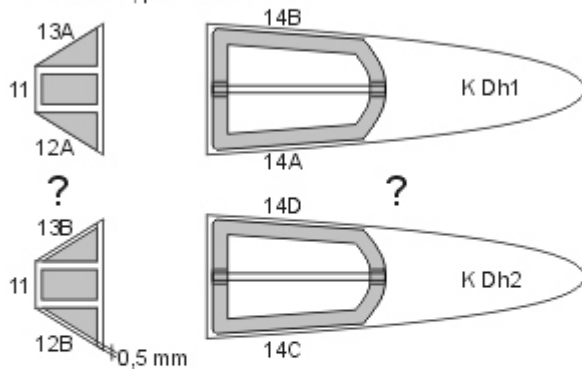

### STEP 2

mask exterior, paint camouflage color

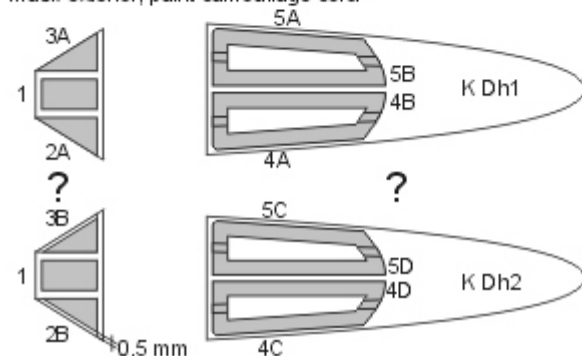



Use also NWAM1384 or NWAM1385 FOCKE-WULF FW 190D-9 masks

**Important:**

Let the sprayed color dry before applying masks. Remove masks very carefully after painting.

Where the mask is divided into A and B parts, first apply part A, next part B.

The set does not include masks for all areas, so mask the rest with masking tape or liquid mask.

K kit part

\* start placing the mask from this point

Placing wet masks on wet surface is recommended, except those marked by **W**

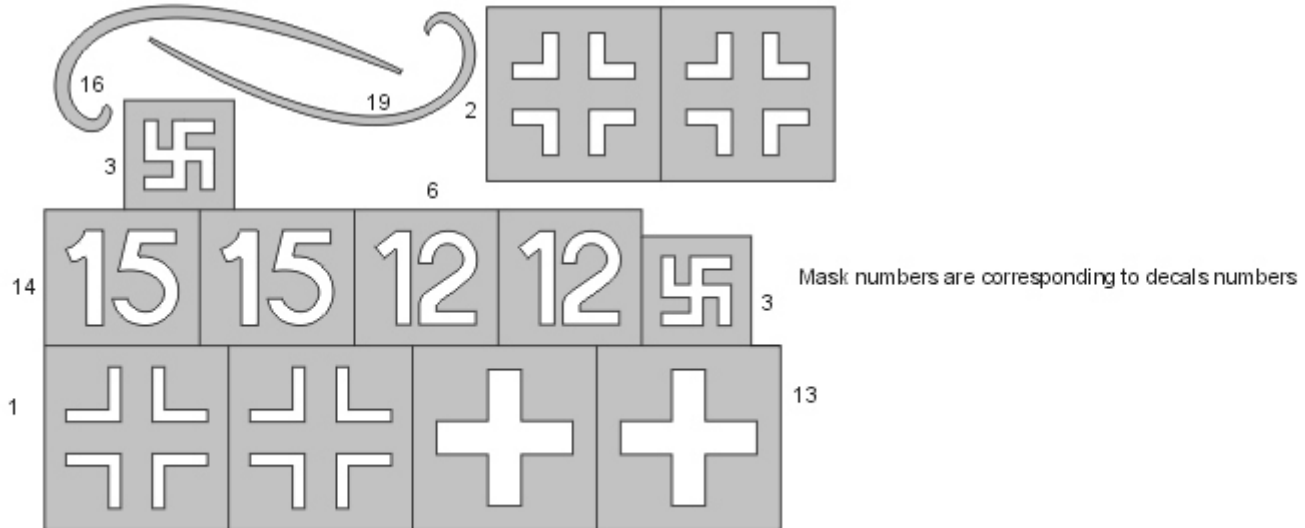

Mask numbers are corresponding to decals numbers

WHITE - SPARE MASKS



HP.52 Hampden B.Mk.I BASIC kabuki masks

for ICM 48352 kit

<http://mek.kosmo.cz/newware>

tom.nwkits@seznam.cz

**Important:**

Let the sprayed color dry before applying masks. Remove masks very carefully after painting. Where the mask is divided into A and B parts, first apply part A, next part B. The set does not include masks for all areas, so mask the rest with masking tape or liquid mask.

K kit part

\* start placing the mask from this point

Placing wet masks on wet surface is recommended, except those marked by **W**

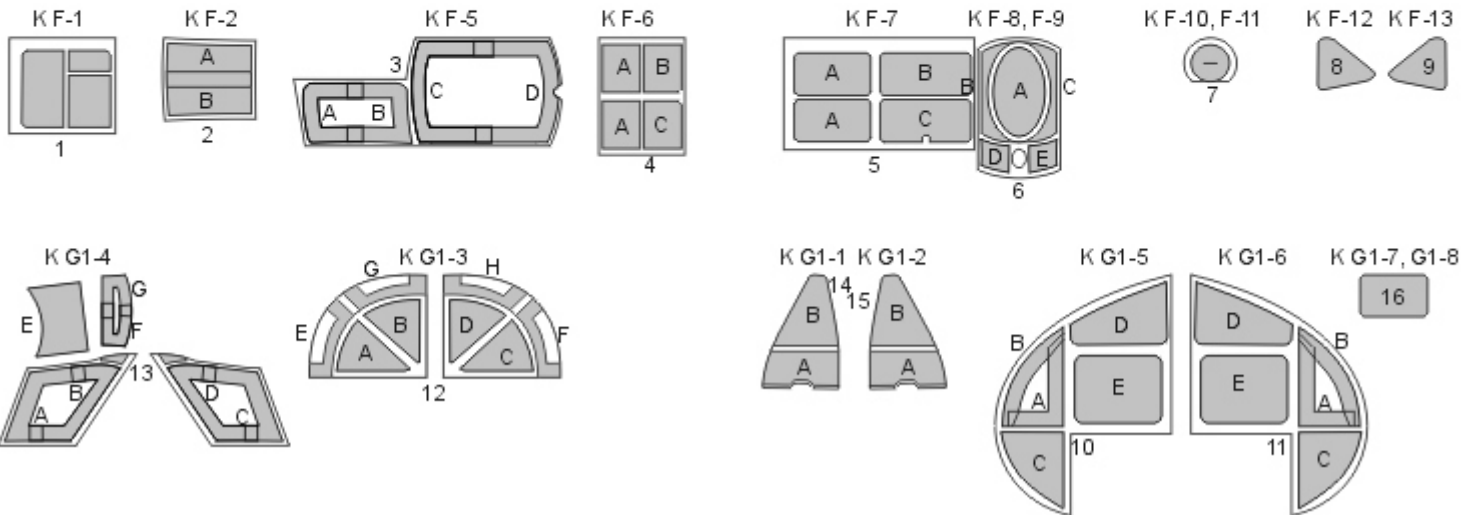
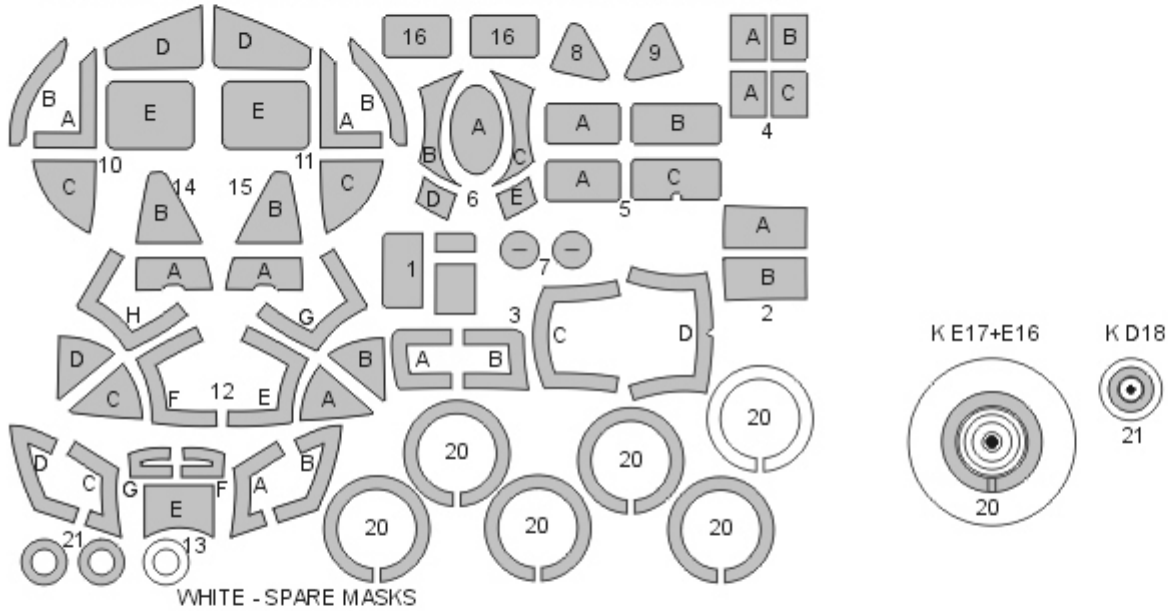

# NWAM1388



HP.52 Hampden B.Mk.I EXPERT kabuki masks  
for ICM 48352 kit

<http://mek.kosmo.cz/newware>

INCLUDES ALSO AIRCRAFT CANOPY  
INNER SIDE MASKS

1/48 scale

tom.nwkits@seznam.cz

### Important:

Let the sprayed color dry before applying masks. Remove masks very carefully after painting.

Where the mask is divided into A and B parts, first apply part A, next part B.

The set does not include masks for all areas, so mask the rest with masking tape or liquid mask.

K kit part

\* start placing the mask from this point

Placing wet masks on wet surface is recommended, except those marked by **W**

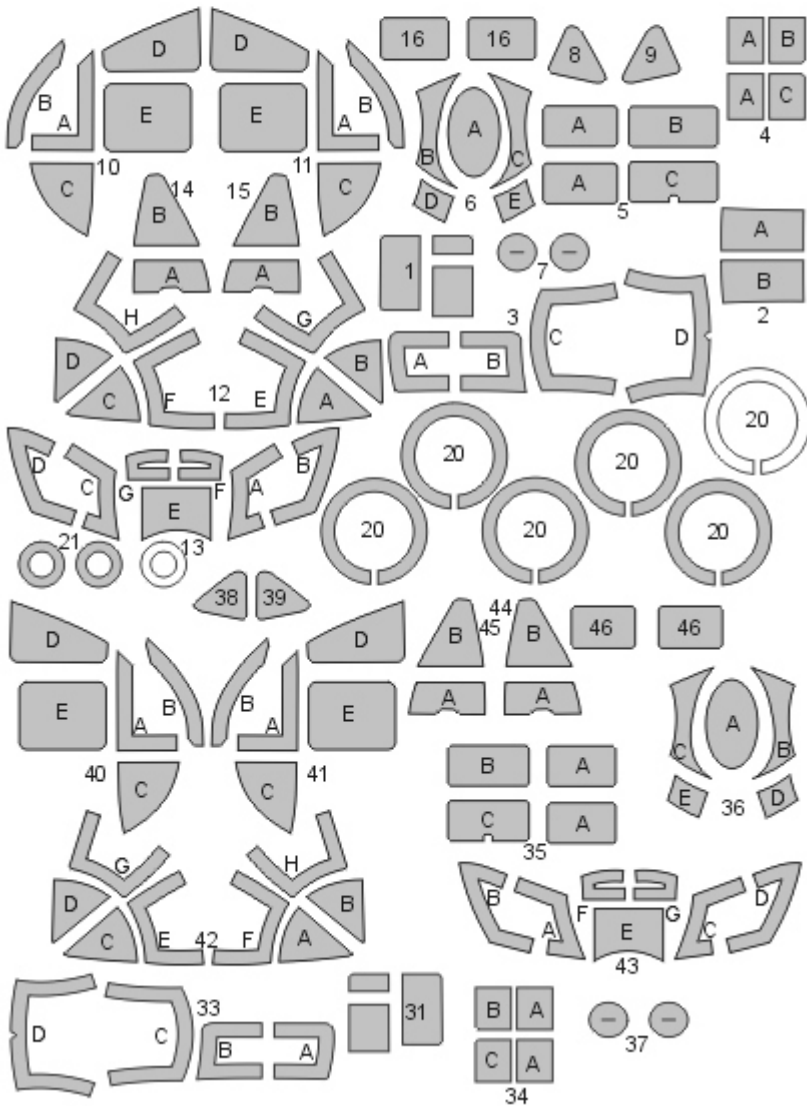

WHITE - SPARE MASKS

STEP 1 (exterior view)  
mask interior

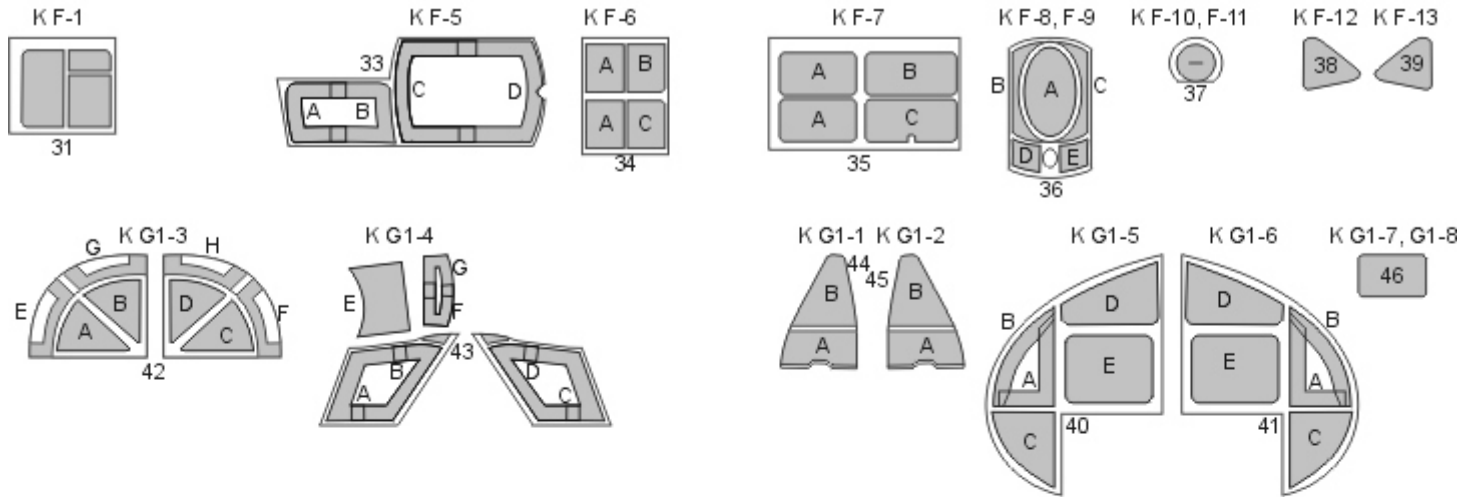

STEP 2  
mask exterior

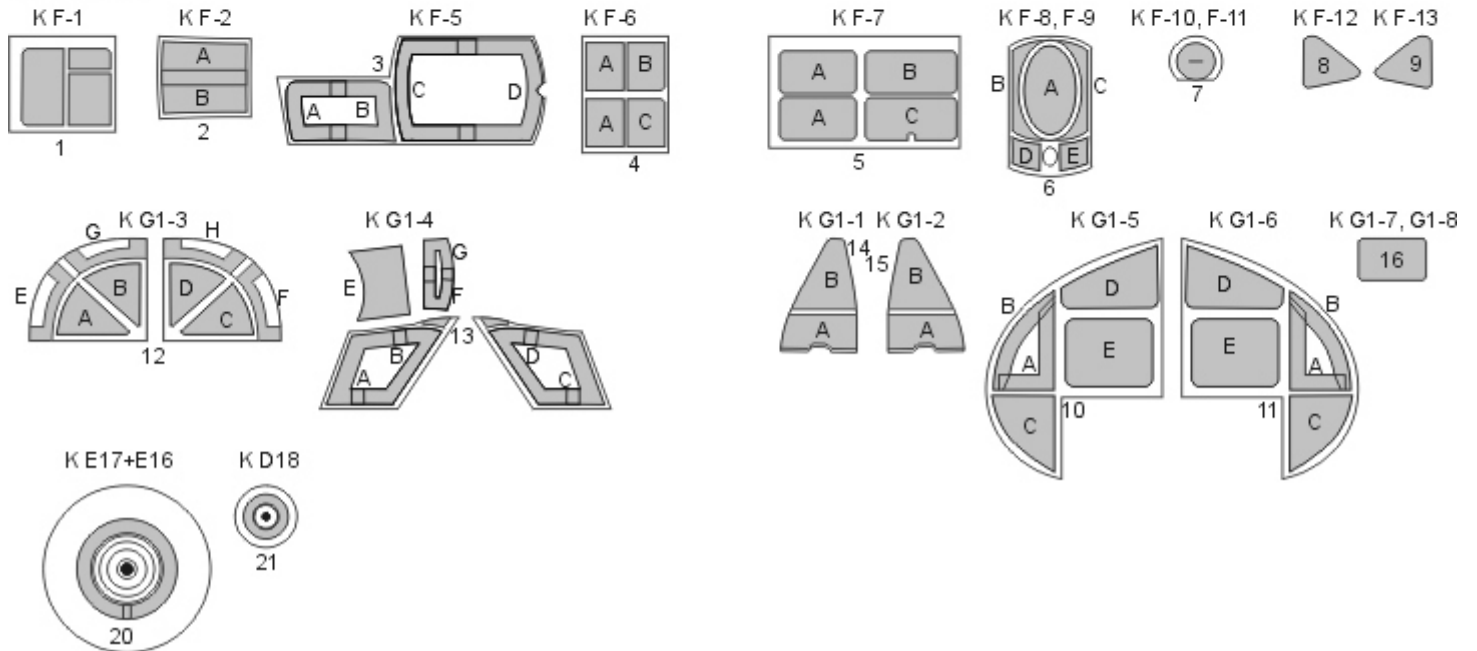



**Important:**

Let the sprayed color dry before applying masks. Remove masks very carefully after painting. Where the mask is divided into A and B parts, first apply part A, next part B. The set does not include masks for all areas, so mask the rest with masking tape or liquid mask.

K kit part

\* start placing the mask from this point

Placing wet masks on wet surface is recommended, except those marked by **W**

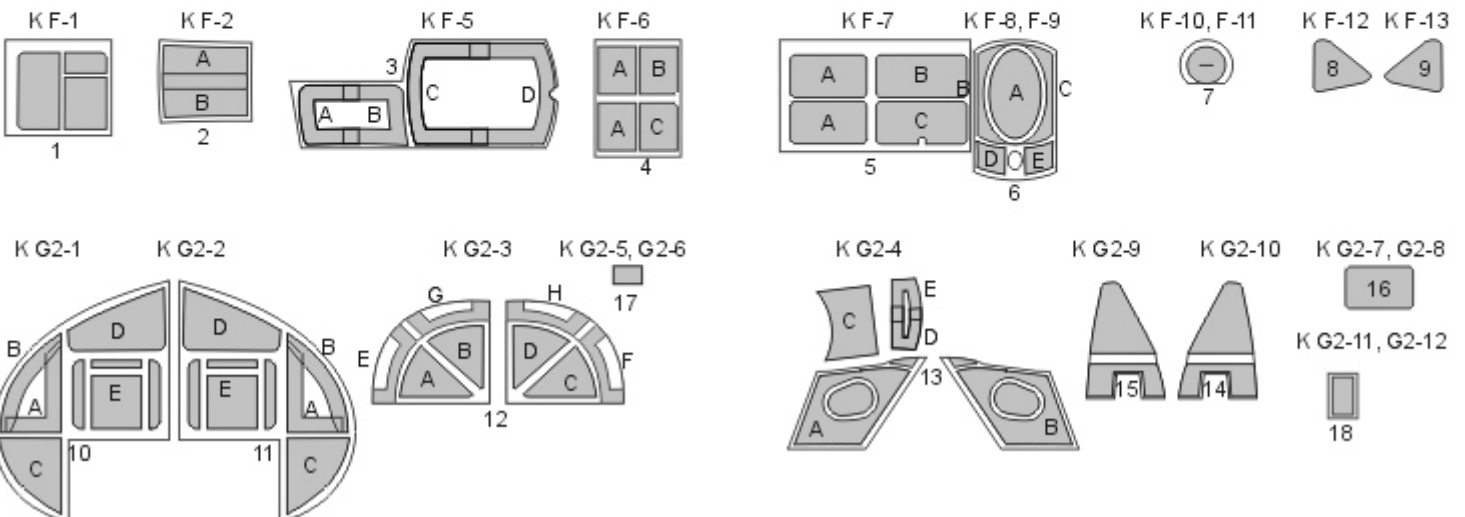
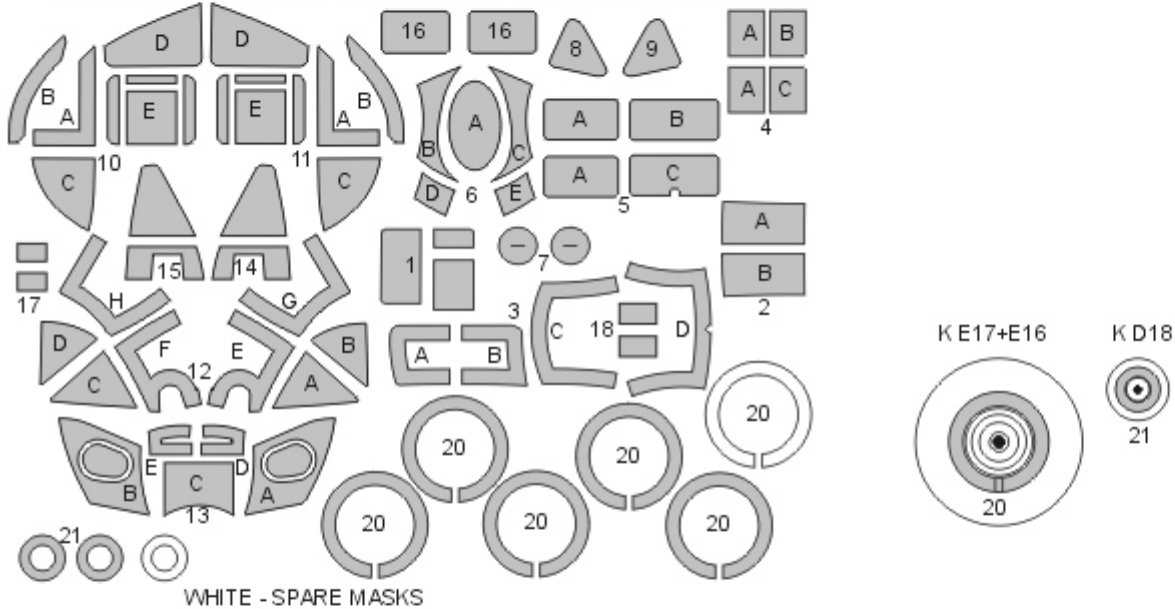

# NWAM1390



## HP.52 Hampden TB.Mk.I EXPERT kabuki masks

### for ICM 48353 kit

<http://mek.kosmo.cz/newware>

INCLUDES ALSO AIRCRAFT CANOPY  
INNER SIDE MASKS

1/48 scale

tom.nwkits@seznam.cz

#### Important:

Let the sprayed color dry before applying masks. Remove masks very carefully after painting.

Where the mask is divided into A and B parts, first apply part A, next part B.

The set does not include masks for all areas, so mask the rest with masking tape or liquid mask.

K kit part

\* start placing the mask from this point

Placing wet masks on wet surface is recommended, except those marked by **W**

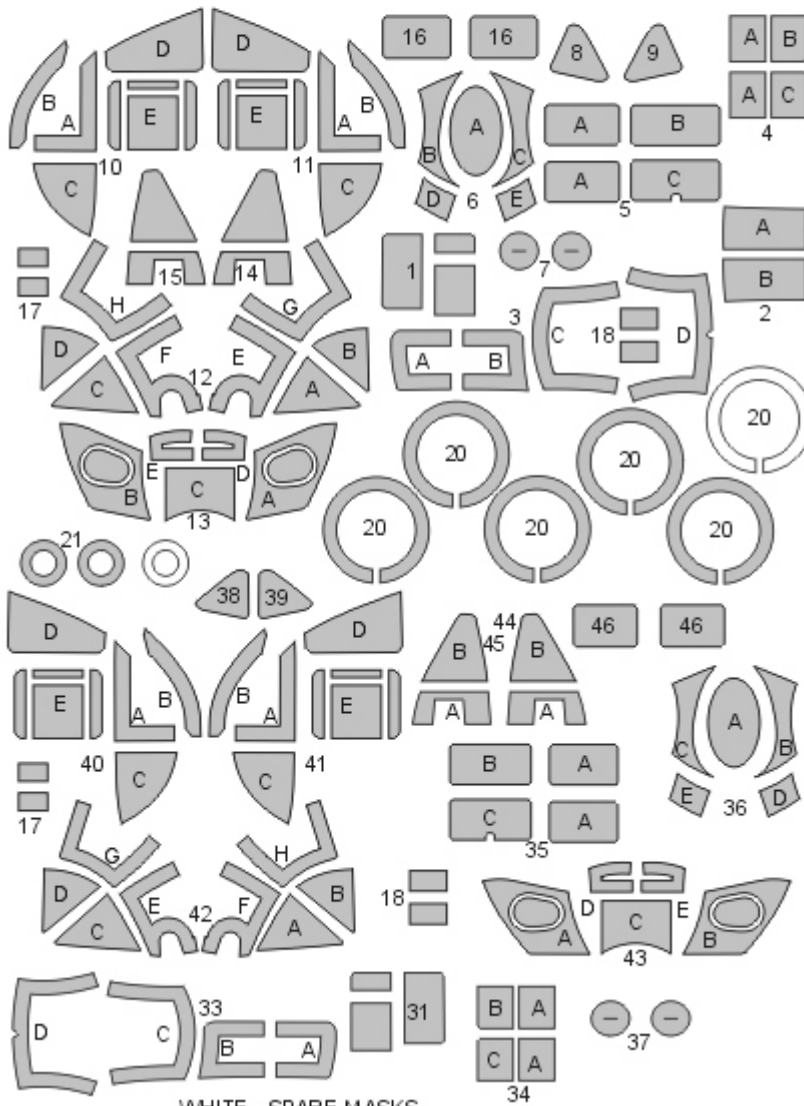

WHITE - SPARE MASKS

STEP 1 (exterior view)  
mask interior

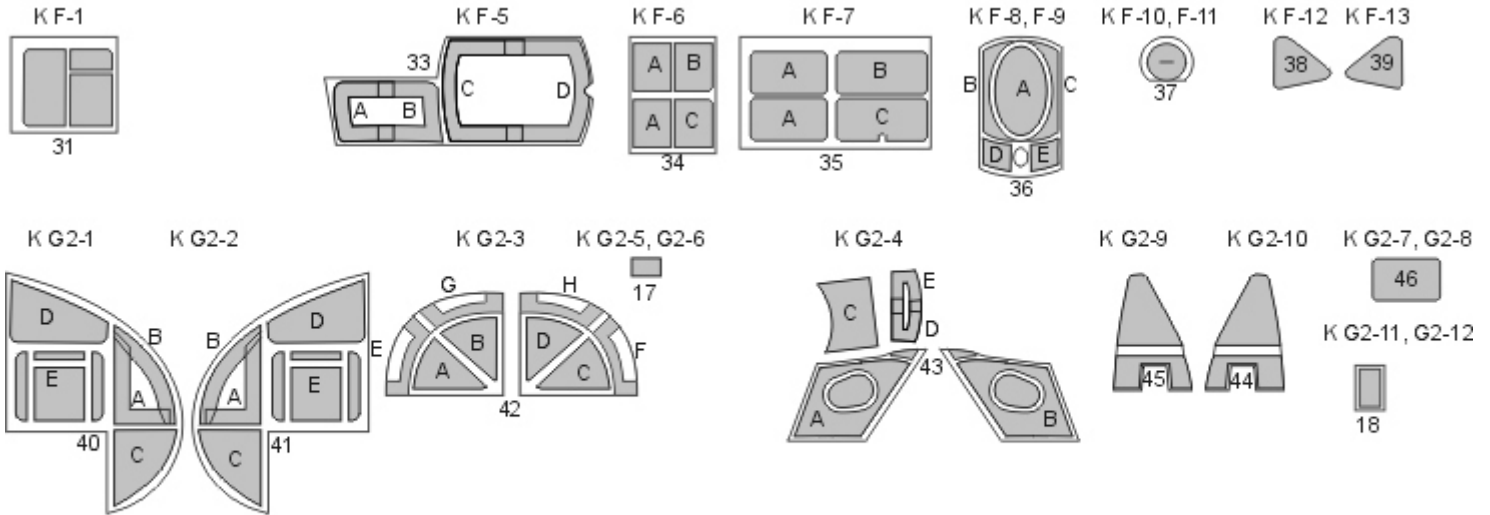

STEP 2  
mask exterior

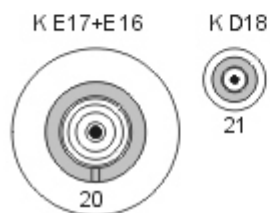
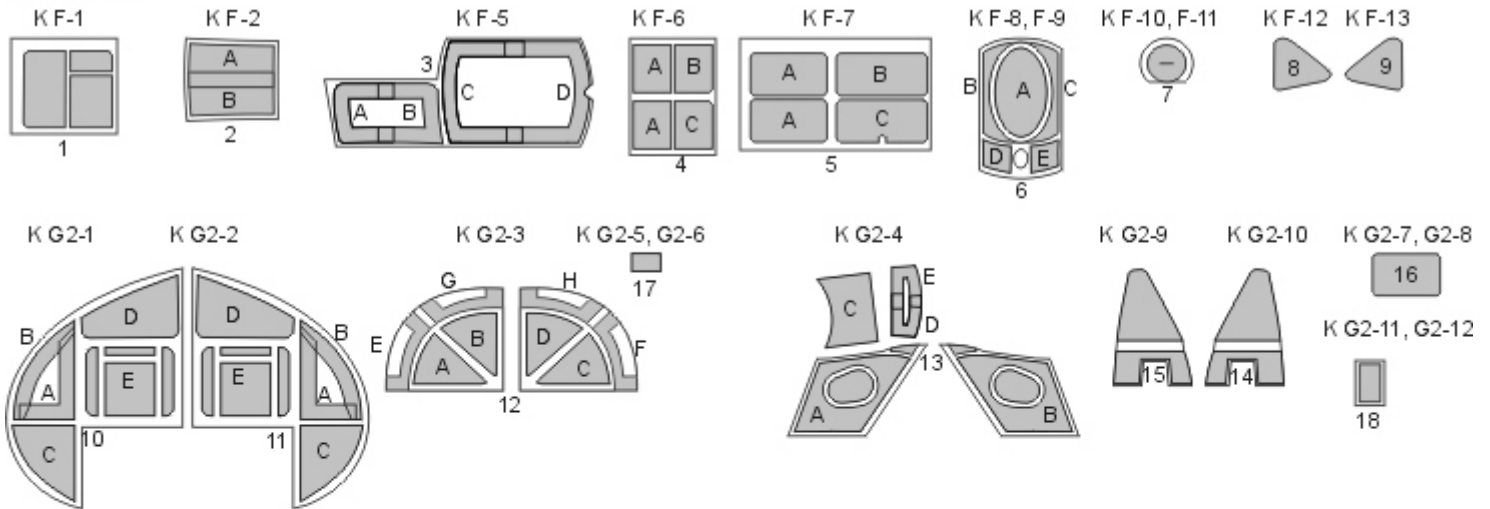

NWAM1391

1/72 scale



F-86A BASIC kabuki masks

for Clear Prop CP72054 kit

<http://mek.kosmo.cz/newware>

[tom.nwkits@seznam.cz](mailto:tom.nwkits@seznam.cz)

**Important:**

Let the sprayed color dry before applying masks. Remove masks very carefully after painting.

Where the mask is divided into A and B parts, first apply part A, next part B.

The set does not include masks for all areas, so mask the rest with masking tape or liquid mask.

K kit part

\* start placing the mask from this point

Placing wet masks on wet surface is recommended, except those marked by **W**

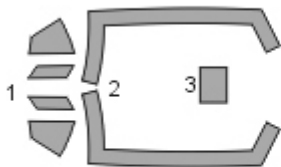



# NWAM1392

## F-86A EXPERT kabuki masks

### for Clear Prop CP72054 kit

<http://mek.kosmo.cz/newware>

INCLUDES ALSO AIRCRAFT CANOPY  
INNER SIDE AND CAMOUFLAGE  
DETAILS MASKS

1/72 scale

tom.nwkits@seznam.cz

#### Important:

Let the sprayed color dry before applying masks. Remove masks very carefully after painting.

Where the mask is divided into A and B parts, first apply part A, next part B.

The set does not include masks for all areas, so mask the rest with masking tape or liquid mask.

K kit part

\* start placing the mask from this point

Placing wet masks on wet surface is recommended, except those marked by **W**

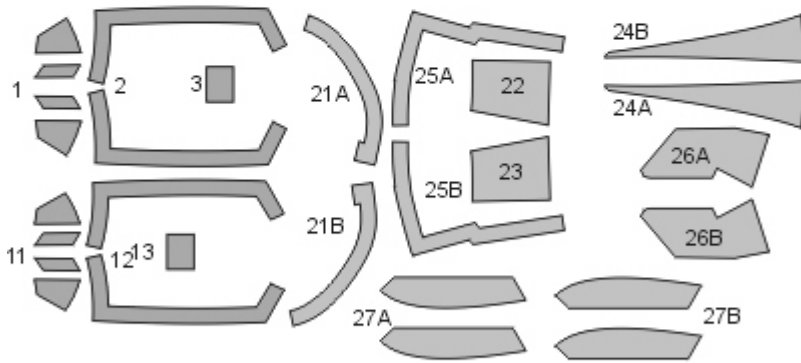

STEP 1  
mask interior, paint interior color



STEP 2  
mask exterior, paint camouflage color

